



LIMPOPO

PROVINCIAL GOVERNMENT
REPUBLIC OF SOUTH AFRICA

DEPARTMENT OF PUBLIC WORKS, ROADS & INFRASTRUCTURE

LDPWRI-B/20151

BID DOCUMENT

FOR THE

**CONSTRUCTION OF NEW VLEIFONTEIN LIBRARY
IN VHEMBE DISTRICT**

MINIMUM CIDB GRADING: 6GB

November 2021

DEPARTMENT OF PUBLIC WORKS, ROADS & INFRASTRUCTURE
Private Bag x9490, Polokwane 0700
Tel: (015) 284-7000

BID NO:

LDPWRI-B/20151

BID DOCUMENT

FOR THE

CONSTRUCTION OF NEW VLEIFONTEIN LIBRARY

IN

VHEMBE DISTRICT

FOR

***DEPARTMENT OF PUBLIC WORKS, ROADS &
INFRASTRUCTURE
LIMPOPO PROVINCE***

NOVEMBER 2021

CONTENTS

PART A: SPECIAL NOTES TO BIDDERS.....	1
PART T1: TENDERING PROCEDURE.....	14
T1.1 TENDER NOTICE AND INVITATION TO TENDER.....	14
T1.2 TENDER DATA.....	15
A. BID EVALUATION STAGE 3 - FUNCTIONALITY.....	21
PART T2: RETURNABLE DOCUMENTS.....	29
T2.1: LIST OF RETURNABLE DOCUMENTS.....	30
T2.2: RETURNABLE SCHEDULE.....	32
SBD 1: INVITATION TO BID.....	33
CERTIFICATE OF AUTHORITY.....	33
A. CERTIFICATE FOR COMPANY.....	33
B. CERTIFICATE OF PARTNERSHIP.....	33
C. CERTIFICATE FOR JOINT VENTURE.....	34
D. CERTIFICATE FOR THE SOLE PROPRIETOR.....	34
E. CERTIFICATE FOR CLOSE CORPORATION.....	34
F. BROAD-BASED BLACK ECONOMIC EMPOWERMENT.....	41
SBD 4: DECLARATION OF INTEREST.....	44
SBD 6.1: REFERENCE POINTS CLAIM FORM IN TERMS OF THE PREFERENTIAL PROCUREMENT REGULATIONS 2017.....	47
SBD 6.2: DECLARATION CERTIFICATE FOR LOCAL PRODUCTION AND CONTENT.....	54
LOCAL CONTENT DECLARATION.....	57
GUIDANCE DOCUMENT FOR THE CALCULATION OF LOCAL CONTENT.....	59
TREASURY DESIGNATED SECTOR.....	62
ANNEX B: LOCAL CONTENT DECLARATION.....	75
ANNEX C: LOCAL CONTENT DECLARATION – SUMMARY SCHEDULE.....	77
ANNEX D: IMPORTED CONTENT DECLARATION – SUPPORTING SCHEDULE TO ANNEX C.....	82
ANNEX E: LOCAL CONTENT DECLARATION – SUPPORTING SCHEDULE TO ANNEX C.....	84
SBD 8: DECLARATION OF BIDDER’S PAST SUPPLY CHAIN MANAGEMENT PRACTICES.....	89

SBD 9: CERTIFICATE OF INDEPENDENT BID DETERMINATION	91
SAFCEC JOINT VENTURE AGREEMENT	98
THE CONTRACT	110
PART C1: AGREEMENT AND CONTRACT DATA	111
C1.1. FORM OF OFFER AND ACCEPTANCE	112
C2 CONTRACT DATA	115
PART C3: PRICING DATA	116
C3.1 PRICING INSTRUCTION	117
PART C4: BILLS OF QUANTITIES	118
PART C5: SCOPE OF WORKS	371
C5.1 SCOPE OF WORKS	372
PART C6: EPWP INFRASTRUCTURE GUIDELINE 2015	373
PART C7: SITE INFORMATION AND DRAWINGS	387
PART C7.1: SITE INFORMATION	388
PART C7.2: SPECIFICATIONS AND DRAWINGS	389
PART C7.2.1: ARCHITECTS SPECIFICATIONS AND DRAWINGS	
PART C7.2.2: ELECTRICAL SPECIFICATIONS AND DRAWINGS	
PART C7.2.3: MECHANICAL SPECIFICATIONS AND DRAWINGS	
PART C7.2.4: STRUCTURAL SPECIFICATIONS AND DRAWINGS	
PART C7.2.5: CIVIL SPECIFICATIONS AND DRAWINGS	
PART C7.2.6: GEOTECHNICAL REPORT	
PART C7.2.7: OHS RISK ASSESSMENT	1-51
PART C7.2.8: OHS SAFETY SPECIFICATIONS	1-78

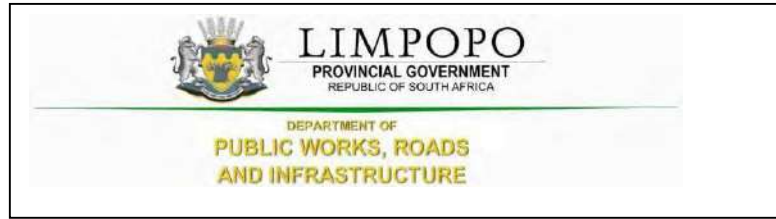

PART A: SPECIAL NOTES TO BIDDERS

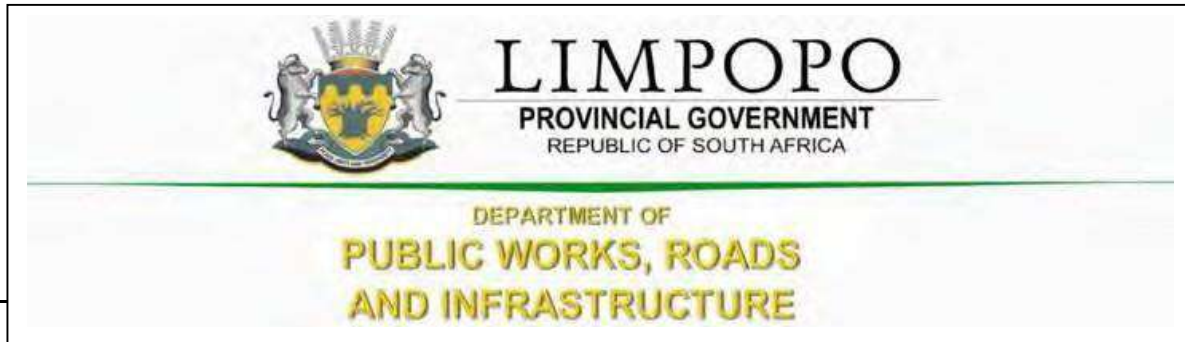

NOTES TO BIDDERS

NAME OF PARTIES

EMPLOYER

Limpopo Province Department of Roads & Infrastructure: Works Towers

43 Church Street

Tel: (015) 284 7000/1

Private BAG X9490

POLOKWANE

0700

Contact:

Maluleke ZV @ (015) 284 7219

PROFESSIONAL TEAM (ARCHITECT, QUANTITY SURVEYOR AND ENGINEERING)

Limpopo Province Department of Public Works, Roads and Infrastructure,

Polokwane

Contact: (015) 284 7001

1. SPECIAL CONTRACT DOCUMENTS

Note:

The clauses in these Special Contract Conditions form part of the contract requirements and shall have preference over any contradicting clauses in these Bills of Quantities, the preliminaries, and the Conditions of Contract.

1.1 CONTRACT DOCUMENTS

The Contract Document will consist of:

- I. The agreement shall be the JBCC Series 2000 Principal Building Agreement, prepared by the Joint Building Contracts Committee, Edition 4.1, and March 2005 amended as hereinafter described.
- II. Documents to be provided by the Contractor in terms of the requirements of these Provisional Bills of Quantities. Where reference is made to the "subcontract agreement" this is deemed to mean the "JBCC Series 2000 Nominated /Selected Sub-Contract Agreement" (March 2005 Edition)
- III. The JBCC Series 2000 Preliminaries prepared by the Joint Building Contracts Committee (May 2005 edition) amended as hereinafter described, shall be deemed to be incorporated herein.
- IV. Tenderers are referred to the above -mentioned documents for the full intent and meaning of each clause thereof. These clauses are hereinafter referred to by clause numbers and headings only, for which, such allowance must be made as may be considered necessary.
- V. Where standard clauses or alternatives are not entirely applicable to this contract such modifications, corrections or supplements as will apply are given as far as possible under each relevant clause. Where modifications or amendments as described are made, such modifications and/or amendments shall supersede any conflicting provision in the relevant clauses of the JBCC Series 2000 Preliminaries or the JBCC Series 2000 Principal Building Agreement and the tenderer shall make due allowance for whatever costs and charges he may consider necessary for the carrying out and observance of the provisions of the clauses as modified and/or amended.
- VI. Where any clause is not relevant to this specific contract such clause is marked N/A (signifying "not applicable").
- VII. "The Model Preambles for Trades" as recommended and published by the Association of South Africa Quantity Surveyors -1999 edition, shall be deemed to form part of this contract documentation. Any amendments and/or additional information is listed under the supplementary preambles at the start of each trade in the bills of quantities.
- VIII. **Pricing of preliminaries - The relevant clause numbers of sections A and B of the preliminaries are listed at the end of the contract preliminaries section for pricing purposes.** if Alternative as set out in clause 10 of the preliminaries hereinafter is to be used for the adjustment of the preliminaries, each item priced is to be allocated to one or more of the three categories.

- IX. The **tenderer** shall allow opposite each of the items for whatever costs and charges he may consider necessary for the carrying out, complying with and due observance of the provisions, conditions, and requirements set out therein.
- X. Only priced items will be considered in respect of any adjustments to this section. Any items left unpriced will be understood to be provided for in the rates given for other items and no claim for extras arising out of the tenderer's omission to price any item will be entertained.
- XI. Notwithstanding the period stated in the JBCC form of tenders, tenderers shall hold good for a period of one hundred and eighty (180) calendars days from the date of closing of the tenderers and shall not be altered, amended, or withdrawn during that period.

2.2 QUERIES FROM BIDDERS

The pages of these bills of quantities are numbered consecutively as indexed on the first page.

The Bidder shall check the numbers of the pages and should any be missing or duplicated, or the reproduction be indistinct, or if any doubt exists as to the full intent or meaning of any description or these bills of quantities contain any obvious errors, the Bidder shall notify the Accounting Officer/ Quantity surveyor at once who shall promptly give a written directive. No liability whatsoever will be admitted in respect of errors in any BID due to the abovementioned causes.

On no account should these documents be used for placing orders for materials. Bidders do so at their own risk and shall not be reimbursed for additional costs so incurred.

2.3 ACQUAINTANCE WITH BID DOCUMENTS

By submission of a BID, the Bidder will be deemed to have acquainted himself/herself fully with the BID documents, local authority requirements and by-laws and all aspects of the work envisaged in the documents before pricing and submission of his/ her BID. The employer may appoint a principal Agent to act on his/ her behalf with full authority and obligations.

2.4 FORMS TO BE COMPLETED

The form of BID together with its appendices must be submitted with the BID.

2.5 SCOPE OF THE WORKS

The project comprises the **CONSTRUCTION OF NEW VLEIFONTEIN LIBRARY IN WATERBERG DISTRICT** as well as related services in accordance with the drawings and specifications that will be provided to the contractor.

The Contractor shall provide sufficient qualified technical staff, field staff, and safety personnel to ensure the Works under this contract be satisfactorily carried out safely and meeting the performance targets and programs. The Contractor shall also provide competent attendant(s) to monitor any works concerning the scope of works.

2.6 PROGRAMMING WITH DIRECT CONTRACTORS

Tenderers must take note that some work may be performed by independent/ direct contractors that will not form part of this contract. Tenderers, however, must make provision for these installations in their program and must provide all the necessary assistance to The **Limpopo Department of Public Works, Roads and Infrastructure in completion of the said contracts.**

- Any installations by specialists e.g., Security installation, loose furniture

2.7 SITE

The site is at VLEIFONTEIN Library, in WATERBERG DISTRICT

2.8 CONTRACT DOCUMENTS

The contract/agreement will be based on the JBCC Series 2000 Principal Building Agreement, prepared by the Joint Building Contracts Committee, Edition 4.1, and March 2005.

Wherever reference is made to the terms "Client, Employer or Principal Agent) in the documents, it shall be deemed to mean. The Limpopo Department of Public Works, Roads, and Infrastructure or any person acting in such capacity as well as any officer to whom any power vested in terms of these conditions of the contract have been delegated to.

2.9 CONFIDENTIALITY OF BID DOCUMENTS

All the recipients of BID documents shall be whether they submit a bid or not, treat the details of these documents as confidential and their general content shall not be disclosed or discussed with third parties without the prior approval of the **Limpopo Department of Public Works, Roads, and Infrastructure**.

2.10 BID ALL INCLUSIVE

The Bidder must allow in his/ her BID for all labour, material, transport, handling, construction plant, temporary works, or method of construction where the method of payment allows for various methods of construction, value-added tax and everything else necessary for the execution and completion of the works in accordance with the BID documents

2.11 BILLS OF QUANTITIES

This Bill of Quantities is provisional and subject to be re-measured.

The Contractor / Bidder is warned that if he/ she use any quantities or specifications appearing in these Bills of Quantities for ordering materials, he/ she does so at his/ her own and no liability whatsoever shall be admitted afterward by the **Employer / Limpopo Department of Public Works, Roads, and Infrastructure** for such correctness of such quantities or specifications.

2.12 STAMP DUTY

If applicable, all stamp duties in connection with the contract shall be paid by the Bidder.

2.13 SIGNING OF BIDDERS

The BID must be signed by a representative of the Bidder being duly authorized to do so and Bidders are to attach a company resolution.

2.14 LODGING AND SCRUTINY OF PRICED BILLS OF QUANTITIES

The Bidder's / Contactor's attention is specifically directed to the provision that, before the contract is signed, he/ she is to submit his/ her priced Bills of Quantities with conditions of contract and cast neatly in black ink for checking. The Accounting Officer / Quantity Surveyor will duly check the priced Bills of Quantities and shall make such adjustment of individual prices and rectify discrepancies as he may consider necessary. No artificial prices shall be acceptable.

2.15 ADDITIONAL INFORMATION REQUIRED

The **Employer / Limpopo Department of Public Works, Roads and Infrastructure** may ask any Bidder for a clarification/s of his / her BID. Nevertheless, no Bidder will be permitted to alter his / her BID sum after the BIDs have been opened and read to other bidders, although clarification which does not change the BID may be accepted.

The Employer reserves the right to appoint a firm of public accountants to report on the financial capacity of any Bidder. The Bidder shall provide all reasonable help and information in such an investigation.

All written information submitted by the Bidder together with and in support of his / her BID shall be considered to form the basis on which the BID has been prepared and submitted.

2.16 ARITHMETICAL ERRORS

The Accounting Officer / Quantity Surveyor reserves the right to correct arithmetical or other errors in the Officer / Surveyor for reasons which the Accounting Officer / Quantity Surveyor will indicate, the Bidder will, in terms of Rule 14, be requested to make corrections.

2.17 IMBALANCE IN BIDDED/TENDERED RATES

In the event of there being any rate or rates which are declared to be unacceptable by the Accounting officer/Quantity Surveyor for reasons which the Accounting Officer / Quantity Surveyor will indicate, the Bidder will, in terms of Rule 14, be requested to:

- a) Either justify and specify rate or rates, i.e. to give a financial breakdown on how such rate or rates were obtained or calculated, or
- b) Consider amending and adjusting such rate while retaining the BID sum derived under Sub-rule 15.a unchanged and fixed.

If the Accounting Officer / Quantity Surveyor requests the Bidder to adjust any unacceptable rate or rates, the Accounting Officer / Quantity Surveyor may at his / her discretion limit any such adjustment to rates in specific sections of the bills of quantities. On no account will the Accounting Officer / Quantity Surveyor permit the Bidder to use such an opportunity to re-price extensive sections of the bills of quantities, even though the BID sum remains unchanged.

2.18 ALTERATIONS TO BID DOCUMENTS

No unauthorized alteration or addition shall be made to the form of BID, to the bills of quantities or any other portion of the BID documents. If any such alteration or additions is made and if the bills of quantities of not properly completed, the BID may be rejected, and the Employer will not be bound to by such alterations.

2.19 BID QUALIFICATIONS

BIDs must be submitted strictly in accordance with the BID documents, i.e. without qualifications. Qualifications like statements of interpretation of contract documents must be avoided and any point of doubt or difficulty should be cleared with the Accounting Officer / Quantity Surveyor as early as possible during the BID period. Should any query be found to be any influence to the BID, all other Bidders shall immediately be informed of the particulars by the Accounting Officer / Quantity Surveyor.

2.20 COSTS INCURRED BY BIDDER

The Employer shall not be responsible to pay for the expenses or losses, which may be incurred by any Bidder in the preparation of the BID or in visiting the site in connection herewith.

20.21 BID ACCEPTANCE

The Employer will not be bound to accept the lowest or any BID. No reason for the acceptance or rejection of any BID will be given.

20.22 WITHDRAWAL OF BID AFTER CLOSING DATE

The Bidder may not withdraw his BID after the time set for opening BIDs without any BID having been accepted.

Should a Bidder amend or withdraw his/her BID after the specified date and hour, but prior to his being notified of the acceptance thereof, or should a Bidder after having been notified that his/her BID has been accepted.

- (a) Give notice of his/her inability to execute the contract in terms of his BID; or
- (b) Fail to sign a contract or furnish the security within the period fixed in the BID Conditions reflected on the form of BID or any extended period fixed by the Employer; or
- (c) Fail to execute the contract;

He shall pay all additional expended, damages and/or losses which the Employer may incur in calling for fresh BIDs or by paying the difference between his/her BID and a less favorable BID accepted in terms of the provisions of the last paragraph of this term: Provided that the Employer may at its discretion exempt a Bidder from the provisions of this sub-rule if he believes that the circumstances justify the exemption.

When in circumstances mentioned in the second paragraph of this item, the Employer deems it not desirable to invite fresh BID; then the Employer may accept another BID from those already received. The provisions of **Rule 2.21 above, shall again apply.**

2.23 METHOD OF MEASUREMENT

The Bills of Quantities have been measured in accordance with the 6th Edition of the standard system of Measuring Builders Work.

2.24 AVAILABILITY AND SUBSTITUTION OF MATERIALS

Bidders are urged to make themselves, during BID stage, thoroughly acquainted with the availability of all materials for this project as no claim for non-availability or late delivery of materials will afterward be recognized/considered.

If materials specified are not available or it seems that there will be a delay of materials, then the Bidder must notify the **Employer** at once in writing who will, at his/her discretion, attend to the matter. Once the BIDs are handed in it will be taken that all materials specified in these Bills of Quantities are available and will be delivered on-site for completion of the project within the prescribed contract period.

The Substitution will be strictly subject to the **Employer's** approval.

The **Contractor** must, as far as possible, purchase materials available in the Limpopo Province provided the quality is acceptable. Materials of inferior quality shall under no circumstances be accepted. If the **Contractor** cannot comply with these conditions, he/she must substantiate this in writing with documentary proof from suppliers.

2.25 PROPRIETARY TYPES AND TRADE NAMES

Where reference is made in these Bills of Quantities to proprietary types or names, the products, or materials, etc. referred to are to be exactly as described, the prior approval of the **Employer** must be obtained for any substitution and may be the subject to a variation order.

2.26 SABS SPECIFICATIONS

All references in these Bills of Quantities to Specifications of the Bureau of Standards shall be deemed to be a reference to the latest issues of such specifications, and any subsequent amendments thereto. All articles, materials or items described as to conform to the SABS Specification must bear the SABS mark where possible.

2.27 PERFORMANCE GUARANTEE

Where the project is over R 2 000 000.00 the Bidder must submit with this BID proof (using a letter of intent or otherwise) from his/her guarantor that his/her guarantor will issue the guarantee if the BID is accepted.

2.28 BID

While the Employer reserves the right to accept or not accept any BID, the intention is that a BID will be accepted. The successful Bidder will be appointed as the Main Contractor in terms of the JBCC Series 2000 Principal Building Agreement, prepared by the Joint Building Contracts Committee, Edition 4.1, and March

2005. Any condition submitted by the Bidders which is a variance with the provisions of the main contract will not be accepted and may render the BID liable to disqualification.

The BID shall be sealed in an envelope and endorsed as per BID form and be deposited in the BID box as per BID advert.

On no account will BIDS received after the time and date for submission of BIDS be considered and Bidders are advised that postal delays will not constitute a claim for recognition of such BIDS.

Telegraphs or telefaxed BIDS will **NOT** be considered under any circumstances.

2.29 INSPECTION OF SITE

A Compulsory site inspection will be as per tender advert. Tenderers are, however, urged to thoroughly inspect the site, acquaint themselves with the nature and extent of the works, the site conditions about power and water supply, transport facilities, conditions of adjacent existing buildings and also access to the site, availability of working space, etc.; before submitting their BIDS **as no extra cost arising out of their failure to price for the above mentioned shall be considered.**

2.30 SITE OFFICE

The Contractor shall erect, maintain, and takedown on completion of the work a building for site meetings with a concrete floor, suitable roof, suitable walls, door, and four windows, with tables and chairs (not benches), all suitable to accommodate 12 persons.

It is further a condition that all work or movement of vehicles in the vicinity of this office that creates noise or nuisance during site meetings must be suspended for the duration of the site meetings.

2.31 LOCAL LABOUR

As soon as the site is handed to the Contractor, he/she will be expected to form a joint committee with the local community. This committee will ensure that all unskilled and available semi-skilled labor are employed from the community.

All labour shall apply through the committee for employment on the project and the selection of these labourers shall be made by the Contractor from a list of applicants compiled by the community members on the committee.

On all labour-intensive projects, at least 10% of the labourers must be employed from the local community where the project will be executed.

Labourers should be paid in accordance with the provision of the Labour Relations Act, Act 23 of 1956 and the amended Basic Conditions of Employment of 1983, or any latest available Acts.

In accordance with Government Gazette No.16095 of 19 November 1994 wages differ for different areas.

2.32 PROCEDURE OF THE WORK

The Employer reserves the right to direct the order in which the various parts of the contract will be executed should circumstances warrant such action.

2.33 VARIATIONS

Where prices are submitted by the Contractor or Nominated Sub-Contractor during the progress of the works in respect of variations or regarding a claim under the terms of the contract and even though such prices may be used in an interim certificate, it is hereby agreed that there is to be no presumption of acceptance. Should the Employer wish to accept any such prices before the issue of the final certificate, he will do so in writing.

2.34 PROVISIONAL WORK

Any increase or decrease of work measured provisionally will not be sufficient grounds for any adjustments in the tendered rates.

2.35 MONEY/BUDGET OR PROVISIONS

Whatever an amount for work is allowed in these Bills of Quantities under the term "Money/budgetary Provision" it shall be taken that such amount is for work to be carried out by Specialists, who will be ordinary domestic Sub-Contractors to the Main Contractor.

2.36 BORROW PITS

It is the responsibility of the Contractor to find the necessary borrow pits for imported filling and also to ascertain the suitability and acceptability of such filling, as no claims in this regard will be entertained afterward.

2.37 TESTS

It is the responsibility of the Contractor to carry out his/her tests during the execution of the contract to check the strength of concrete, mortar, the density of filling, etc., and only those tests as requested by the Employer will be paid for by the Client.

2.38 THE CONTRACT PERIOD

The contract period shall be 12 months (exclusive of builder's holiday) from the date of site handover.

2.39 COMPLETION OF BID DOCUMENTS

Bidders shall ensure that all documents requiring completion are duly completed in ink (black), signed, and witnessed in the spaces provided.

2.40 OCCUPATIONAL HEALTH AND SAFETY

In terms of the Occupational Health and Safety Regulations promulgated on 18 July 2003, Bidders are advised that they are required to comply fully with such regulations about this project as no claims in this regard will be entertained.

2.41 VALUE ADDED TAX

Value-added tax must be added to the contract amount in the Final Summary and all amounts, rates, etc. in the Bills of Quantities will, therefore, be exclusive of value-added tax.

2.42 PRICES ALL INCLUSIVE

The Bidder must allow in his/her BID for all labour, material, transport, handling, construction plant, temporary works, or method of constructions where the method of payment allows for various methods of construction, value-added tax and everything else necessary for the execution and completion of the works in accordance with the BID documents.

2.43 PROOF OF PAYMENT OF VALUE ADDED TAX OR ANY APPLICABLE IMPORT DUTY

The Bidder is to provide proof that he/she and all his Sub-Contractors are registered at the Receiver of Revenue for VAT or any applicable import duty purposes and will submit all names of Sub-Contractors to the Employer. The Employer may submit all this information to the Receiver of Revenue.

2.44 WORKMEN'S COMPENSATION

The Contractor must provide valid proof of active registration with the workmen's compensation fund (COIDA).

2.45 CONTRACT PRICE ADJUSTMENT

The BID will be subject to Escalation and the base month will be based on the date of tender closing.

2.46 GENERAL NOTES

Should the tender be awarded to the successful tenderer, the following is to be noted:

- No works shall commence until the Health and Safety Plan has been issued by the successful tenderer and has been approved by the Department of Public Works, Roads and Infrastructure representative.
- No work shall commence on site until all CAR and PL insurances are in place
- No payment shall be made until all guarantees are in place.
- Workers employed by the Contractor will not be allowed to be seen lingering around existing facilities or disturbing classes.
- The Contractor must not render any construction activities that will affect the Client operation before informing the Employer for approval thereof.
- The Contractor's workers should be noticeable by wearing proper clothing with the company logo.

2.47 PAYMENT PROCEDURE

Payment procedure in terms of this contract shall be as follows:

- The Contractor to submit valuation by the 20th of the Month.
- The payment shall be issued to the Department of Sports, Arts and Culture by the 7th of the following month, with payment being made by the 30th of that month.
- Every effort will be made to achieve payments earlier, but this cannot be guaranteed.

- Interest on late payments shall be charged at the prime rate.
- Payment for unfixed materials (Material on site) on-site shall be allowed.
- Payment for materials off-site shall only be allowed subject to written approval by the Employer, which will only be conditional upon the necessary cessions being in place and any other documentation which the Employer requests.

2.48 INFORMATION RELEVANT TO INSURANCES

The Contractor will be expected to take the following insurance with a deductible to be determined by the Contractor. In addition to the above-mentioned, the Contractor should take any other insurances relevant to the proper execution of the works.

2.49.1 CONTRACT WORKS

– Estimated Contract Amount plus 20%

2.49.2 PUBLIC LIABILITY

– R 10 000 000.00

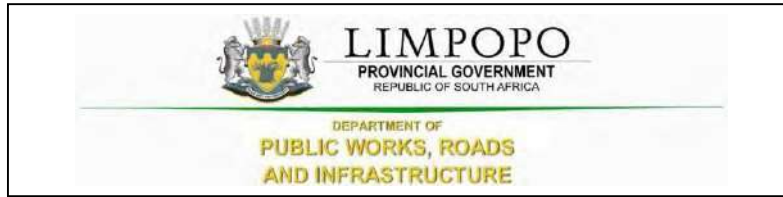

PART T1: TENDERING PROCEDURE

T1.1 TENDER NOTICE AND INVITATION TO TENDER

The Limpopo Department of Public Works, Roads and Infrastructure invites tenders for the **CONSTRUCTION OF NEW VLEIFONTEIN LIBRARY IN WATERBERG DISTRICT**.

It is estimated that tenderers should have a CIDB **class grading of 6GB or higher**.

Only tenderers who meet the minimum requirements stated in the tender data are eligible to submit tenders.

A non-refundable tender deposit of **as per Tender Advert** payable in cash is required on collection of the tender documents.

Tender documents are obtainable at Works Towers, Department of Public Works, Roads, and Infrastructure, 43 Church Street, Polokwane, during the following times: 08:00 to 15:00 (Monday to Friday) as from **as per Tender Advert**.

Queries relating to the issue of these documents may be addressed in writing to **Ms Moloto V**, **Tel. No.015 284 7142**; email: molotomv@dpw.limpopo.gov.za.

A compulsory briefing meeting with representatives of the Employer will not take place due to the Covid-19 Lockdown restrictions. However, tenderers are welcomed to make arrangements to visit the site on a non-compulsory basis at the **VLEIFONTEIN LIBRARY IN WATERBERG DISTRICT**.

The closing date and time for receipt of tenders are **as per Tender Advert**.

Telegraphic, telephonic, scanned documents, facsimile, e-mail, and late tenders will not be accepted.

Tenders must only be submitted on the tender documentation that is issued including priced bills of quantities.

Requirements for sealing, addressing, delivery, opening and assessment of tenders are stated in the Tenders Data.

It remains the responsibility of the bidders that the bid document reaches the tender box by the stipulated closing date and time as advertised on the tender bulletin.

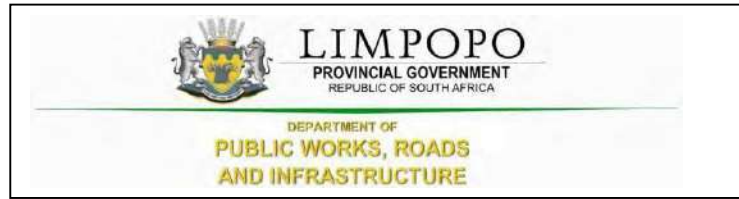

T1.2 TENDER DATA

The conditions of tender are the Standard Conditions of Tender as contained in Annex F of the CIDB Standard for Uniformity in Construction Procurement (July 2015) as published in Government Gazette No 38960, Board Notice 136 of 10 July 2015. (See www.cidb.org.za).

The Standard Conditions of Tender make several preferences to the Tender Data for details that apply specifically to this tender. The Tender Data shall have precedence in the interpretation of any ambiguity or inconsistency between it and the Standard Conditions of Tender.

Each item of data given below is cross-referenced to the clause in the Standard Conditions of Tender to which it mainly applies.

Clause number	Tender Data
F.1.1	The Employer is the Limpopo Department of Public Works, Roads and Infrastructure

<p>F.1.2</p>	<p>For this contract, the following documents will be adopted: The single-volume procurement document issued by the employer comprises of the following:</p> <p>Part A1: Special Notes to Bidders</p> <p>The Tender Part T1: Tendering procedures T1.1 Tender notice and invitation to tender T1.2 Tender data</p> <p>Part T2: Returnable documents T2.1 List of returnable documents T2.2 Returnable schedules</p> <p>The Contract Part C1: Agreements and contract data C1.1 Form of offer and acceptance C1.2 Contract data</p> <p>The Contract Part C3: Pricing data C3.1 Pricing instructions</p> <p>The Contract Part C4: Provisional Bills of Quantities C4.1 Preliminaries C4.2 Building Works C4.3 Electrical Installation C4.4 Mechanical Installation C4.5 Civil Works C4.6 External Works C4.7 COVID-19 Health and Safety Compliance C4.8 Provisional Sums</p> <p>Part 5: Scope of work C5.1 Scope of work</p> <p>Part 6: EPWP Infrastructure Guideline 2015 C6.1 Data Collection Tool</p> <p>Part 7: Site information and drawings C7.1 Site information C7.2 Drawings</p>
<p>F.1.3</p>	<p>The employer's representative is:</p> <p>Name : V Maluleke Address : Department of Public Works, Roads and Infrastructure. Works Towers, 43 Church Street. Tel : 015 284 7219 Fax:</p>
<p>F.1.4</p>	<p>The language for communications is English</p>
<p>F.2.1</p>	<p>Only those Bidders who satisfy the following eligibility criteria are eligible to submit tenders:</p> <ol style="list-style-type: none"> 1. The Bidder is a Firm. 2. Bidders that satisfy the criteria stated in the tender data and the tenderer or any of his principles is not under any restriction to do business with the employer.

F.2.2	<p>Compulsory site briefing</p> <p>A compulsory site briefing meeting with representatives of the Employer will not take place due to the Covid-19 Lockdown restrictions. However, tenderers are welcomed to make arrangements to visit the site on a non-compulsory basis at the VLEIFONTEIN LIBRARY IN WATERBERG DISTRICT.</p>
F.2.3	<p>Tenderers may request clarification of the tender documents by notifying the employer at least five (5) working days before the closing time and date stated in the Tender Advert.</p>
F.2.4	<p>No alternative tender offers will be considered.</p>
F.2.5	<p>The list of Returnable Documents identifies which of the documents a tenderer must complete when submitting a tender offer. The tenderer must submit his tender offer by completing the Returnable Documents, signing the "Offer" section in the "Form of Offer and Acceptance" and delivering the Returnable Documents back to the Department.</p>
F.2.6	<p>Sign the original and all copies of the tender offer where required in terms of the tender data. The employer will hold all authorized signatories liable on behalf of the tenderer. Signatories for tenderers proposing to contract as consortiums shall state which of the signatories the lead is partner whom; the employer shall hold liable for the tender offer.</p>
F.2.7	<p>The employer's details and address for delivery of tender offers and identification details that are to be shown on each tender offer package are:</p>
F.2.8	<p>Location of the tender box: Department of Public Works, Roads and Infrastructure,</p> <p>Physical Address: Corner River and Blaauwberg streets, Ladanna, 0699.</p> <p>Identification details: Tender reference number, Title of Tender and the closing date and time of the tender.</p>
F.2.9	<p>Telephonic, telegraphic, telex, facsimile or e-mailed tender offers will not be accepted.</p>
F.2.10	<p>Tenderers are alerted that tender offers which do not provide all the data or information requested completely and, in the form, required, may be regarded by the employer as non-responsive.</p>
F.2.11	<p>The closing time for submission of tender offers is as stated in the Tender Notice and Invitation to Tender.</p>
F.2.12	<p>The tender offer validity period is 180 Days.</p>
F.2.13	<p>A valid Tax Clearance / Compliance Certificate, or a unique security Personal Identification Number (PIN) issued by the South African Revenue Services (where Consortium / Joint Venture / Sub-contractors / Sub-consultants are involved, each party to the association must submit a separate Valid Tax Clearance / Compliance Certificate or a unique security personal Identification number)</p>
F.3.1	<p>Tenders will not be opened immediately after the closing time for tenders.</p>
F.3.2	<p>The tenderers will be evaluated in four stages</p> <ul style="list-style-type: none"> (i) Compliance documents – refer to the list of returnable documents (Part T2) (ii) Local Content (SBD 6.2) and its Annexures (iii) Functionality (iv) Price and Preference (BBBEE)

<p>F.3.3</p>	<p>Scoring Financial Offer:</p> <p>Tender offers will be scored using the following formula: $NFO = \left(\frac{Pm}{P} \right) \times 100$</p> <p>Where</p> <p>NFO = number of tender evaluation points awarded for the financial offer.</p> <p>W1 = the percentage score given for financial offer as stated in the Notice and Invitation to Tender T1.1</p> <p>Pm = the comparative offer of the most favourable tender offer. P = the comparative offer of the tender offer under consideration.</p> <p>where</p> <p>W1 = the number of tender evaluation points for the financial offer and equals:</p> <ol style="list-style-type: none"> 1) 90 where the financial value inclusive of VAT of all responsive tenders received has a value above R 50 000 000; or 2) 80 where the financial value inclusive of VAT of one or more responsive tender offers equals or is less than R 50 000 000. <p>Scoring Preferences:</p> <p>Up to 20 points will be awarded to the tenderer who completes the referencing schedule and who is found to be eligible for the preference claimed</p>
	<p><i>The Department is not obliged to award the tender to the bidder with the highest number of tender points.</i></p>

TENDER EVALUATION CRITERIA AND WEIGHTINGS

NOTES TO BIDDERS

1.1 CRITERIA USED FOR THE EVALUATION/ ADJUCATION OF INFRASTRUCTURE RELATED BIDS

1.1.1 The points are allocated as follows:

1.1.2 For projects above R500 000, the distribution of points is used as follows:

A. BID EVALUATION STAGE 2- LOCAL CONTENT (SBD 6.2)

1.1 A bid may be disqualified if the Local Content Declaration Certificate and the Annexure C (Local Content Declaration: Summary Schedule) are not submitted as part of the bid documentation.

1.2 This tender is subject to Regulation 8 “Local Production and Content” of the Preferential Procurement Policy Framework Act, 2017: Preferential Procurement Regulations, 2017 submitting of SBD 6.2 and its declarations is compulsory. Please note a minimum threshold of for local content and production in relation to this bid (refer to the list of Designated Items for Local Production and Content)

1.2.1 Evaluation in terms of the stipulated minimum threshold for local production and content. LDPWRI-B/20015 will be evaluated in terms of minimum thresholds for local content stipulated in the LDPWRI-B/20015 document. The declaration made by the BIDDER in the Declaration Certificate for Local Content and Annex C (Local Content Declaration: Summary Schedule) will be used for this purpose.

1.2.2 All responses that will not meet the required minimum threshold “Annexure 1 (SBD 6.2” for local content as stipulated in the specifications will be disqualified and not evaluated further. Only Bidders that achieved the minimum threshold for local content and production will be evaluated further in terms of functionality and preference point system prescribed in the Preferential Procurement Regulations, 2017.

1.2.3 All Declarations for Local Content and Production must be fully completed and signed.

N.B Bidders will need to meet a minimum threshold percentage for local production and content as stipulated in the Bid Document (refer to the list of Designated Items for Local Production and Content) to be further evaluated in terms of the 80/20 preference point system prescribed in the Preferential Procurement Policy Framework Act, 5/2000 and preferential procurement regulations of 2017.

1.2.4 The exchange rate to be used for the calculation of Local Production and Content must be the exchange rate published by the South African Reserve Bank (SARB) during the advertisement period of this LDPWRI-B/20151.

1.2.5 Only the South African Bureau of Standards (SABS) approved technical specification number SATS 1286:2011 will be used to calculate local content.

2.6 The Local Content (LC) expressed, as a percentage of the bid price will be calculated in accordance with the following formula:

$$LC = (1 - x/y) * 100$$

Where

X is the imported content in Rand

Y is the quotation price in Rand excluding value added tax (VAT)

1. The exchange rate to be used for the calculation of local production and content must be the exchange rate published by the South African Reserve Bank (SARB) at 11:00 on Friday, 21 February 2020.

2. Only the South African Bureau of Standards (SANS) approved technical specification number SATS 1286:2011 must be used to calculate local content.

A. BID EVALUATION STAGE 3 - FUNCTIONALITY

NOTE: Functionality -A bidder must obtain a minimum of 70% under functionality to qualify for final evaluation.

Responsive bids will be evaluated using a point system which awards on the basis set out in the table below:

Functionality	Weighting
<p>Current Workload of Bidder</p> <ul style="list-style-type: none"> • The current value is equal or greater than twice the maximum value of the required CIDB grade = 0 • The current value is greater than the maximum value of the required CIDB grade but less than twice the maximum value of the required CIDB grade = 5 • The current value is within the required CIDB threshold = 12 • The current value is less than the minimum value of the required CIDB grade = 20 <p>Current value refers to the current value of projects for both General Building (GB) and Civil Engineering (CE). Please list the current projects which your company is busy executing in Table 1.</p> <p>NB: Completion of this table is mandatory for points to be allocated. Do not refer to any attachment. If no projects at the moment the tenderer must indicate on this table. Misrepresentation of facts will render your bid non-responsive.</p>	<p>20</p>

<p>Profile of key staff (the key staff must be linked to project-specific organogram). CVs and certified copies of qualifications must be attached for points to be allocated. NB: List the details of key staff in Table 2. Completion of this table is mandatory for points to be allocated.</p>	<p>Weighting</p>
<p>Project Supervisor/Site Agent</p> <p>Qualification</p> <ul style="list-style-type: none"> • Registration as a professional engineer, technologist, architect, construction manager or quantity surveyor = 5 • Degree in built environment = 3 • National Diploma in Built environment = 1 <p>Experience</p> <ul style="list-style-type: none"> • 5 years' experience or more = 5 • Between 2- and 5-years' experience = 3 • Less than 2 years = 1 <p>Construction Manager</p> <p>Qualification</p> <ul style="list-style-type: none"> • Registration as a professional engineer, technologist, architect, construction manager or quantity surveyor = 5 • Degree in built environment = 3 • National Diploma in Built environment = 1 <p>Experience</p> <ul style="list-style-type: none"> • 5 years' experience or more = 5 • Between 2- and 5-years' experience = 3 • Less than 2 years = 1 <p>Site Safety Officer</p> <ul style="list-style-type: none"> • Registration with the South African Council for Project and Construction Management Professions (SACPCMP) as a Construction Health and Safety Officer / Construction Health and Safety Manager = 5 • No registration with the South African Council for Project and Construction Management Professions (SACPCMP) as a Construction Health and Safety Officer / Construction Health and Safety Manager = 0 <p>Experience</p> <ul style="list-style-type: none"> • 5 years' experience or more = 5 • Between 2- and 5-years' experience = 3 • Less than 2 years = 1 	<p style="text-align: center;">30</p>

Table 2 Details of key staff.

Name	Position	Qualifications	Professional Registration (if any)	Experience: Number of year (s)	Indicate whether full time or part-time on this project

Experience in similar projects in the last 10 years	Weighting
<ul style="list-style-type: none"> • Similar Projects = 5 to 20 • If Project(s) value is greater than 1,5 times the maximum value of the required CIDB grade = 20 • If Project(s) value is greater than the maximum value of the required CIDB grade but less than 1,5 times the maximum value of the required CIDB grade = 15 • If Project(s) value is within the required CIDB threshold = 10 • If Project(s) value is equal to or greater than the minimum value of the required CIDB grading and less than twice the minimum value of the required CIDB grade = 5 • If Project(s) value is less than the minimum value of the required CIDB grade = 0 • If Projects value is for unrelated project (s) = 0 <p>NB: The details of completed projects must be entered in Table 3. Completion of this table is mandatory for points to be allocated. Appointment letters and completion certificates must be attached for points to be allocated.</p>	20

Proposal and methodology	Weighting
<ul style="list-style-type: none"> • Project Proposal/Method Statement Project Proposal/Approach =10 <ul style="list-style-type: none"> - Project Proposal / Method Statement covers all aspects of the project scope of work and construction procedures = 10 - Project Proposal / Method Statement partly covers aspects of the project scope of work and construction procedures = 5 - Project Proposal / Method Statement does not cover any aspects of the project scope of work of work and construction procedures = 0 • Project Schedule/programme (acceptable scheduling software) Programme Schedule/programme Gantt Chart =10 <ul style="list-style-type: none"> - Programme must be in line with the scope of work and contract period and the activities sequencing must be logical. • Cashflow projections The cash flow projections =10 <ul style="list-style-type: none"> - The Cashflow must be in line with the construction program. 	<p>30</p>

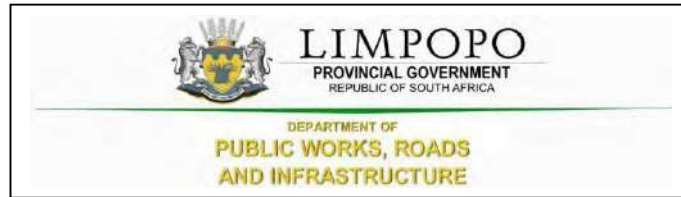

PART T2: RETURNABLE DOCUMENTS

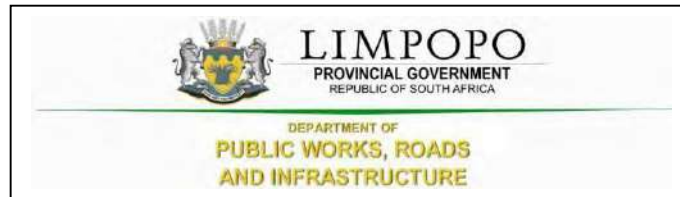

T2.1: LIST OF RETURNABLE DOCUMENTS

BID EVALUATION STAGE 1- MANDATORY REQUIREMENTS

1. The following returnable documents are compulsory, failure to comply will be considered non-responsive, and the bid will not be evaluated any further. All returnable documents are incorporated into the bid documents.
 - SBD1: Invitation to Bid (fully completed and signed)
 - Submit a power of attorney/Certificate of Authority (fully completed and signed)
 - Record of Addenda (where applicable)
 - SBD 4: Declaration of Interest
 - SBD 6.1: Reference Points claim form in terms of the Preferential Procurement Regulations 2017 or amended.
 - SBD 6.2 Declaration Certificate for Local Production and Content
 - SBD 8: Declaration of the bidder's past SCM practices
 - SBD 9: Certificate of Bid determination
 - C1.1: Form of the offer (PART C1)
 - Joint venture certificate (where applicable)
 - Bidding entity must not have any of their directors/shareholders listed on the Register of Tender Defaulters in terms of the Prevention and Combating of Corrupt Activities Act of 2004 as a person prohibited from doing business with the public sector;
 - Bidding entity must not appear on the National Treasury's list of blacklisted entities
 - Completion of the Bid Document must be done with a non-erasable black pen
 - Submission of fully completed original tender document
 - Proof of Contractor Registration issued by the Construction Industry Development Board –Compulsory
 - Submission of fully Completed and Priced Bill of Quantities
 - Copy of COIDA (Compensation for Occupational Injuries and Diseases) registration certificate, e.g. Letter of Good Standing

2. The following returnable documents are **required for tender evaluation purposes**.
 - Curriculum Vitae (not longer than 4 pages) of all key staff allocated to this project, indicating their experience and qualifications and professional registration with various councils.
 - Certified copies (not older than 6 months from the date of certifying) of all qualifications, professional registrations, and training.
 - Letters of completion for previous or current work on appropriate letterhead and signed off by the client must be attached. The letters must detail the scope of work undertaken, project value is undertaken, date of award and completion, and the location where work was carried out.
 - Proof of ownership of the plant or confirmation of rental agreement thereof.
 - Methodology documentation, detailing the bidder's approach to executing the scope of works, risk, and environmental impact
 - Signed Preferencing Schedule, including submitting the supporting documents
 - B-BBEE Verification Certificates issued by a verification agency accredited by the South African National Accreditation System "SANAS" (In the case of a consortium and Joint venture, a Joint BBEE certificate is required, but where sub-contracting only the BBEE of the bidding entity is required). Or in the case of an Exempted Micro Enterprise or a Qualifying Small Enterprise, if permitted in terms of the relevant code,
 - A duly completed and valid affidavit on the relevant form obtained from the DTI website (https://www.thedti.gov.za/economic_empowerment/bee_codes.jsp). Failure to submit these documents will result in no points allocated.

- A Tax Compliance Status Pin issued by the South African Revenue Services (where Consortium / Joint Venture / Sub- contractors / Sub-consultants are involved, each party to the association must submit a separate Tax Compliance Status Pin)
- Joint Venture or Consortium submissions are eligible; Joint Venture Agreement must be notarized by the commissioner of oath.

KINDLY NOTE THAT FAILURE TO SUBMIT AND OR COMPLETE THE REQUIRED DOCUMENTATION (AS PER MANDATORY REQUIREMENTS INCLUDING COMPLETION OF SBD 1, 4, 6.1, 6.2, 8 and 9) WITH THE TENDER WILL RESULT IN YOUR TENDER BEING REJECTED WITHOUT FURTHER CONSIDERATION.

T2.2: RETURNABLE SCHEDULE

Bidders shall indicate whether the list of returnables has been submitted together with the following completed documents or attachments (by indicating Yes or No)		Complaint	
1.	SBD1: Invitation to Bid	Yes	No
2.	Certificate of Authority	Yes	No
3.	Record of Addenda to the tender	Yes	No
4.	Compulsory Declaration	Yes	No
5.	Preferencing schedule: Broad-based Black Economic Empowerment status	Yes	No
6.	Proposed amendments and qualifications (if applicable)	Yes	No
7.	SBD 4: Declaration of Interest	Yes	No
8.	SBD 6.1: Reference Points claim form in terms of the Preferential Procurement Regulations 2017 or amended	Yes	No
9.	SBD 6.2 Declaration Certificate for Local Production and Content	Yes	No
10.	SBD 8: Declaration of the bidder's past SCM practices	Yes	No
11.	SBD 9: Certificate of Bid determination	Yes	No
12.	Form of offer	Yes	No
13.	CSD	Yes	No
14.	COIDA	Yes	No
15.	Valid tax clearance certificate or tax pin	Yes	No
16.	Joint venture certificate (where applicable)	Yes	No
17.	B-BBEE Verification Certificates issued by a verification agency accredited by the South African National Accreditation System (SANAS)	Yes	No
18.	Certified copies of Qualifications, Professional registration, and Training for Key persons	Yes	No
19.	Methodology/Method statement	Yes	No
20.	Certificates or letters of completed or current similar projects, with Contactable references and on the Client's letterhead	Yes	No
21.	Minimum CIDB class grading: 6GB or higher.	Yes	No
22.	Preliminary Programme/schedule and cash flow	Yes	No

**PART A
INVITATION TO BID**

SBD 1

YOU ARE HEREBY INVITED TO BID FOR REQUIREMENTS OF THE (NAME OF DEPARTMENT/ PUBLIC ENTITY)					
BID NUMBER:		CLOSING DATE:		CLOSING TIME:	
DESCRIPTION					
THE SUCCESSFUL BIDDER WILL BE REQUIRED TO FILL IN AND SIGN A WRITTEN CONTRACT FORM (SBD7).					
BID RESPONSE DOCUMENTS MAY BE DEPOSITED IN THE BID BOX SITUATED AT (STREET ADDRESS)					
SUPPLIER INFORMATION					
NAME OF BIDDER					
POSTAL ADDRESS					
STREET ADDRESS					
TELEPHONE NUMBER	CODE		NUMBER		
CELLPHONE NUMBER					
FACSIMILE NUMBER	CODE		NUMBER		
E-MAIL ADDRESS					
VAT REGISTRATION NUMBER					
		TCS PIN:		OR	CSD No:
B-BBEE STATUS LEVEL VERIFICATION CERTIFICATE [TICK APPLICABLE BOX]		<input type="checkbox"/> Yes <input type="checkbox"/> No		B-BBEE STATUS LEVEL SWORN AFFIDAVIT <input type="checkbox"/> Yes <input type="checkbox"/> No	
IF YES, WHO WAS THE CERTIFICATE ISSUED BY?					
AN ACCOUNTING OFFICER AS CONTEMPLATED IN THE CLOSE CORPORATION ACT (CCA) AND NAME THE APPLICABLE IN THE TICK BOX		<input type="checkbox"/> AN ACCOUNTING OFFICER AS CONTEMPLATED IN THE CLOSE CORPORATION ACT (CCA)			
		<input type="checkbox"/> A VERIFICATION AGENCY ACCREDITED BY THE SOUTH AFRICAN ACCREDITATION SYSTEM (SANAS)			
		<input type="checkbox"/> A REGISTERED AUDITOR NAME:			
[A B-BBEE STATUS LEVEL VERIFICATION CERTIFICATE/SWORN AFFIDAVIT(FOR EMEs& QSEs) MUST BE SUBMITTED IN ORDER TO QUALIFY FOR PREFERENCE POINTS FOR B-BBEE]					
ARE YOU THE ACCREDITED REPRESENTATIVE IN SOUTH AFRICA FOR THE GOODS /SERVICES /WORKS OFFERED?	<input type="checkbox"/> Yes <input type="checkbox"/> No [IF YES ENCLOSE PROOF]			ARE YOU A FOREIGN BASED SUPPLIER FOR THE GOODS /SERVICES /WORKS OFFERED?	<input type="checkbox"/> Yes <input type="checkbox"/> No [IF YES ANSWER PART B:3 BELOW]
SIGNATURE OF BIDDER			DATE	

BID NO: LDPWRI-B/20151

CAPACITY UNDER WHICH THIS BID IS SIGNED (Attach proof of authority to sign this bid; e.g. resolution of directors, etc.)			
TOTAL NUMBER OF ITEMS OFFERED		TOTAL BID PRICE (ALL INCLUSIVE)	
BIDDING PROCEDURE ENQUIRIES MAY BE DIRECTED TO:		TECHNICAL INFORMATION MAY BE DIRECTED TO:	
DEPARTMENT/ PUBLIC ENTITY		CONTACT PERSON	
CONTACT PERSON		TELEPHONE NUMBER	
TELEPHONE NUMBER		FACSIMILE NUMBER	
FACSIMILE NUMBER		E-MAIL ADDRESS	
E-MAIL ADDRESS	ramavhoyag@dpw.limpopo.gov		

ARE YOU THE ACCREDITED REPRESENTATIVE
 IN SOUTH AFRICA FOR THE GOODS / SERVICES / WORKS OFFERED? YES or NO
 IF YES ENCLOSE PROOF]

SIGNATURE OF BIDDER

DATE.....

CAPACITY UNDER WHICH THIS BID IS SIGNED.....

TOTAL BID PRICE..... TOTAL NUMBER OF ITEMS OFFERED.....

ANY ENQUIRIES REGARDING THE BIDDING PROCEDURE MAY BE DIRECTED TO:

Department:

Contact Person:

Tel:

Fax:

E-mail address:.....

ANY ENQUIRIES REGARDING TECHNICAL INFORMATION MAY BE DIRECTED TO:

Contact Person:

Tel:

Fax:

E-mail address:.....

**PART B
TERMS AND CONDITIONS FOR BIDDING**

SBD 1

1. BID SUBMISSION:	
1.1.	BIDS MUST BE DELIVERED BY THE STIPULATED TIME TO THE CORRECT ADDRESS. LATE BIDS WILL NOT BE ACCEPTED FOR CONSIDERATION.
1.2.	ALL BIDS MUST BE SUBMITTED ON THE OFFICIAL FORMS PROVIDED--(NOT TO BE RE-TYPED) OR ONLINE
1.3.	BIDDERS MUST REGISTER ON THE CENTRAL SUPPLIER DATABASE (CSD) TO UPLOAD MANDATORY INFORMATION NAMELY: (BUSINESS REGISTRATION/ DIRECTORSHIP/ MEMBERSHIP/IDENTITY NUMBERS; TAX COMPLIANCE STATUS; AND BANKING INFORMATION FOR VERIFICATION PURPOSES). B-BBEE CERTIFICATE OR SWORN AFFIDAVIT FOR B-BBEE MUST BE SUBMITTED TO BIDDING INSTITUTION.
1.4.	WHERE A BIDDER IS NOT REGISTERED ON THE CSD, MANDATORY INFORMATION NAMELY: (BUSINESS REGISTRATION/ DIRECTORSHIP/ MEMBERSHIP/IDENTITY NUMBERS; TAX COMPLIANCE STATUS MAY NOT BE SUBMITTED WITH THE BID DOCUMENTATION. B-BBEE CERTIFICATE OR SWORN AFFIDAVIT FOR B-BBEE MUST BE SUBMITTED TO BIDDING INSTITUTION.
1.5.	THIS BID IS SUBJECT TO THE PREFERENTIAL PROCUREMENT POLICY FRAMEWORK ACT 2000 AND THE PREFERENTIAL PROCUREMENT REGULATIONS, 2017, THE GENERAL CONDITIONS OF CONTRACT (GCC) AND, IF APPLICABLE, ANY OTHER LEGISLATION OR SPECIAL CONDITIONS OF CONTRACT.
2. TAX COMPLIANCE REQUIREMENTS	
2.1	BIDDERS MUST ENSURE COMPLIANCE WITH THEIR TAX OBLIGATIONS.
2.2	BIDDERS ARE REQUIRED TO SUBMIT THEIR UNIQUE PERSONAL IDENTIFICATION NUMBER (PIN) ISSUED BY SARS TO ENABLE THE ORGAN OF STATE TO VIEW THE TAXPAYER'S PROFILE AND TAX STATUS.
2.3	APPLICATION FOR TAX COMPLIANCE STATUS (TCS) OR PIN MAY ALSO BE MADE VIA E-FILING. IN ORDER TO USE THIS PROVISION, TAXPAYERS WILL NEED TO REGISTER WITH SARS AS E-FILERS THROUGH THE WEBSITE WWW.SARS.GOV.ZA.
2.4	BIDDERS MAY ALSO SUBMIT A PRINTED TCS TOGETHER WITH THE BID.
2.5	IN BIDS WHERE CONSORTIA / JOINT VENTURES / SUB-CONTRACTORS ARE INVOLVED, EACH PARTY MUST SUBMIT A SEPARATE PROOF OF TCS / PIN / CSD NUMBER.
2.6	WHERE NO TCS IS AVAILABLE BUT THE BIDDER IS REGISTERED ON THE CENTRAL SUPPLIER DATABASE (CSD), A CSD NUMBER MUST BE PROVIDED.
3. QUESTIONNAIRE TO BIDDING FOREIGN SUPPLIERS	
3.1.	IS THE BIDDER A RESIDENT OF THE REPUBLIC OF SOUTH AFRICA (RSA)? <input type="checkbox"/> YES <input type="checkbox"/> NO
3.2.	DOES THE BIDDER HAVE A BRANCH IN THE RSA? <input type="checkbox"/> YES <input type="checkbox"/> NO
3.3.	DOES THE BIDDER HAVE A PERMANENT ESTABLISHMENT IN THE RSA? <input type="checkbox"/> YES <input type="checkbox"/> NO
3.4.	DOES THE BIDDER HAVE ANY SOURCE OF INCOME IN THE RSA? <input type="checkbox"/> YES <input type="checkbox"/> NO
IF THE ANSWER IS "NO" TO ALL OF THE ABOVE, THEN, IT IS NOT A REQUIREMENT TO OBTAIN A TAX COMPLIANCE STATUS / TAX COMPLIANCE SYSTEM PIN CODE FROM THE SOUTH AFRICAN REVENUE SERVICE (SARS) AND IF NOT REGISTER AS PER 2.3 ABOVE.	

NB: FAILURE TO PROVIDE ANY OF THE ABOVE PARTICULARS MAY RENDER THE BID INVALID.

AN ACCOUNTING OFFICER AS CONTEMPLATED IN THE CLOSE CORPORATION ACT (CCA)
 A VERIFICATION AGENCY ACCREDITED BY THE SOUTH AFRICAN ACCREDITATION SYSTEM (SANAS); OR.....
 A REGISTERED AUDITOR
 [TICK APPLICABLE BOX]

(A B-BBEE STATUS LEVEL VERIFICATION CERTIFICATE MUST BE SUBMITTED IN ORDER TO QUALIFY FOR PREFERENCE POINTS FOR B-BBEE)

CERTIFICATE OF AUTHORITY

Indicate the status of the tenderer by ticking the appropriate box hereunder. The tenderer must complete the certificate set out below for the relevant category.

A Company	B Partnership	C Joint Venture	D Sole Proprietor	E Close Corporation

A. CERTIFICATE FOR COMPANY

I,....., chairperson of the board of directors of hereby confirm that by resolution of the board (copy attached) taken on20...., Mr/Mrs.....acting in the capacity of... .., was authorized to sign all documents in connection with this tender and any contract resulting from it on behalf of the company.

As witness

1.....
 . Chairperson
 2.....
 Date

B. CERTIFICATE OF PARTNERSHIP

We, the undersigned, being the key partners in the business trading as hereby authorize Mr/Mrs....., acting in the capacity of.....to sign all documents in connection with the tender forContract... .. and any contract resulting from it on our behalf.

NAME	ADDRESS	SIGNATURE	DATE

NOTE: This certificate is to be completed and signed by all the key partners upon whom rests the direction of the affairs of the Partnership as a whole.

C. CERTIFICATE FOR JOINT VENTURE

We, the undersigned, are submitting this tender offer in Joint Venture and hereby authorize Mr/Mrs....., authorized signatory of the company, acting in the capacity of lead partner, to sign all documents in connection with the tender offer for Contract... .. and any other contract resulting from it on our behalf.

This authorization is evidenced by the attached power of attorney signed by legally authorized signatories of all the partners to the Joint Venture.

NAME OF FIRM	ADDRESS	AUTHORIZING SIGNATURE, NAME & CAPACITY

D. CERTIFICATE FOR THE SOLE PROPRIETOR

I,....., hereby confirm that I am the sole owner of the business trading as.....

As Witness:

1..... Signature: Sole owner
 2..... Date

E. CERTIFICATE FOR CLOSE CORPORATION

We, the undersigned, being the key members in the business trading as.....hereby authorise Mr/Mrsacting in the capacity of....., to sign all documents in connection with the tender for Contract... .. and any contract resulting from it on our behalf.

NAME	ADDRESS	SIGNATURE	DATE

NOTE: This certificate is to be completed and signed by all the key members upon whom rests the direction of the affairs of the Close Corporation as a whole

Record of Addenda to tender documents

We confirm that the following communications received from the Employer before the submission of this tender offer, amending the tender documents, have been taken into account in this tender offer:

	Date	Title or Details
1.		
2.		
3.		
4.		
5.		
6.		
7.		
8.		
9.		
10.		

Attach additional pages if more space is required.

Signed Date.....
 Name Position

Tenderer

Compulsory Declaration

The following particulars must be furnished. In the case of a joint venture, a separate declaration in respect of each partner must be completed and submitted.

Section 1: Enterprise Details

Name of enterprise:	
Contact person:	
Email:	
Telephone:	
Cell no	
Fax:	
Physical address	
Postal address	

Section 2: Particulars of companies and close corporations

Company / Close Corporation registration number	
--	--

Section 3: SARS Information

Tax reference number	
VAT registration number:	<i>State Not Registered if not registered for VAT</i>

Section 4: CIDB registration number

Section 5: National Treasury Central Supplier Database

Supplier number	
Unique registration reference number	

Section 6: Particulars of principals

principal: means a natural person who is a partner in a partnership, a sole proprietor, a director of a company established in terms of the Companies Act of 2008 (Act No. 71 of 2008) or a member of a close corporation registered in terms of the Close Corporation Act, 1984, (Act No. 69 of 1984).

Attach a separate page if necessary

Section 7: Record in the service of the state

Indicate by marking the relevant boxes with a cross, if any principal is currently or has been within the last 12 months in the service of any of the following:

- a member of any municipal council
- a member of any provincial legislature
- a member of the National Assembly or the National Council of Province
- a member of the board of directors of any municipal entity
- an official of any municipality or municipal entity
- an employee of any department, national or provincial public entity or constitutional institution within the meaning of the Public Finance Management Act of 1999 (Act No. 1 of 1999)
- a member of an accounting authority of any national or provincial public entity
- an employee of Parliament or a provincial legislature

If any of the above boxes are marked, disclose the following:

Name of principal	Name of institution, public office, board or organ of state and position held	Status of service (tick appropriate column)	
		Current	Within the last 12 months

*insert separate page if necessary

Section 8: Record of a family member in the service of the state

family member: a person's spouse, whether in a marriage or in a customary union according to indigenous law, a domestic partner in a civil union, or child, parent, brother, sister, whether such a relationship results from birth, marriage or adoption

Indicate by marking the relevant boxes with a cross, if any family member of a principal as defined in section 5 is currently or has been within the last 12 months been in the service of any of the following:

- a member of any municipal council
- a member of any provincial legislature
- a member of the National Assembly or the National Council of Province
- a member of the board of directors of any municipal entity
- an official of any municipality or municipal entity
- an employee of any provincial department, national or provincial public entity or constitutional institution within the meaning of the Public Finance Management Act, 1999 (Act 1 of 1999)
- a member of an accounting authority of any national or provincial public entity
- an employee of Parliament or a provincial legislature

Name of a family member	Name of institution, public office, board or organ of state and position held	Status of service (tick appropriate column)	
		Current	Within the last 12 months

*insert separate page if necessary

Section 9: Record of termination of previous contracts with an organ of state

Was any contract between the tendering entities including any of its joint venture partners terminated during the past 5 years for reasons other than the employer no longer requiring such works or the employer fails to make payment in terms of the contract.

Yes No (Tick appropriate box)

If yes, provide particulars (interest separate page if necessary)

Section 10: Declaration

The undersigned, who warrants that he/she is duly authorized to do so on behalf of the tendering entity confirms that the contents of this Declaration are within my knowledge, and save where stated otherwise in an attachment hereto, are to the best of my belief both true and correct, and:

- i) neither the name of the tendering entity or any of its principals appears on:
 - a) the Register of Tender Defaulters established in terms of the Prevention and Combating of Corrupt Activities Act of 2004 (Act No. 12 of 2004)
 - b) National Treasury's Database of Restricted Suppliers (see www.treasury.gov.za)
- ii) neither the tendering entity or any of its principals has within the last five years been convicted of fraud or corruption by a court of law (including a court outside of the Republic of South Africa);
- iii) any principal who is presently employed by the state has the necessary permission to undertake remunerative work outside such employment (attach permission to this declaration);
- iv) the tendering entity is not associated, linked or involved with any other tendering entities submitting tender offers
- v) has not engaged in any prohibited restrictive horizontal practices including consultation, communication, agreement, or arrangement with any competing or potential tendering entity regarding prices, geographical areas in which goods and services will be rendered, approaches to determining prices or pricing parameters, intentions to submit a tender or not, the content of the submission (specification, timing, conditions of the contract, etc.) or intention to not win a tender;
- vi) has no other relationship with any of the tenderers or those responsible for compiling the scope of work that could cause or be interpreted as a conflict of interest;
- vii) neither the tenderer or any of its principals owes municipal rates and taxes or municipal service charges to any municipality or a municipal entity and are not in arrears for more than 3 months;
- viii) SARS may, on an on-going basis during the term of the contract, disclose the tenderer's tax compliance status to the Employer and when called upon to do so, obtain the written consent of any subcontractors who are subcontracted to execute a portion of the contract that is entered into more than the threshold prescribed by the National Treasury, for SARS to do likewise.

Signed _____ Date _____

Name _____ Position _____

Enterprise _____

NOTE 2: Section 30(1) of the Public Service Act, 1994, prohibits an employee (person who is employed in posts on the establishment of departments) from performing or engaging remunerative work outside his or her employment in the relevant department, except with the written permission of the executive authority of the department. When in operation, Section 8(2) of the Public Administration Management Act, 2014, will prohibit an employee of the public administration (i.e. organs of state and all national departments, national government components listed in Part A of Schedule 3 to the Public Service Act, provincial departments including the office of the premier listed in Schedule 1 of the Public Service Act and provincial departments listed in schedule 2 of the Public Service Act, and provincial government components listed in Part B of Schedule 3 of the Public Service Act) or persons contracted to executive authorities in accordance with the provisions of section 12A of the Public Service Act of 1994 or persons performing similar functions in organs of state from conducting business with the State or to be a director of a public or private company conducting business with the State. The offense for doing so is a fine or imprisonment for a period not exceeding 5 years or both. It is also serious misconduct which may result in the termination of employment by the employer.

NOTE 3: Regulation 44 of Supply Chain Management regulations issued in terms of the Municipal Finance Management Act of 2003 requires that organs of state and municipal entities not award a contract to a person who is the service of the state, a director, manager or principal shareholder in the service of the state or who has been in the service of the state in the previous twelve months.

NOTE 4: Regulation 45 of Supply Chain Management regulations requires a municipality or municipal entity to disclose in the notes to the particulars of the annual statement of any award made to a close family member in the service of the state.

NOTE 5: Corrupt activities which give rise to an offense in terms of the Prevention and Combating of Corrupt Activities Act of 2004) include improperly influencing in any way the procurement of any contract, the fixing of the price, consideration or other amounts of money stipulated or otherwise provided for in any contract and the manipulating by any means of the award of a tender.

NOTE 6: Section 4 of the Competition Act of 1998 prohibits restrictive horizontal practice including agreements between parties in a horizontal relationship that have the effect of substantially preventing or lessening competition, directly or indirectly fixing prices or dividing markets or constitute collusive tendering. Section 5 also prohibits restrictive vertical practices. Any restrictive practices that are suspicious will be reported to the Competition Commission for investigation and possible imposition of administrative penalties.

F. BROAD-BASED BLACK ECONOMIC EMPOWERMENT

Preferencing schedule: Broad-Based Black Economic Empowerment Status

Preamble

Section 10(b) of the Broad-Based Black Economic Empowerment Act of 2003 (Act No. 53 of 2003) states that “Every organ of state and the public entity must take into account and, as far as is reasonably possible, apply any **relevant code of good practice** issued in terms of this Act in developing and implementing a preferential procurement policy.”

A number of codes of good practice have been issued in terms of Section 9(1) of the B-BBEE Act of 2003, including a generic code of good practice and various sector codes. The sector codes vary the metrics, weightings, and targets used in the generic code of good practice to establish the overall performance of an entity and its B-BBEE status. The B-BBEE status needs to be assessed in accordance with the applicable code.

1 Conditions associated with the granting of preferences

Tenderers who claim a preference shall provide proof of B-BBEE status level of contributor in accordance with the requirements of section 2 in respect of the applicable code as at the closing time for submissions, failing which their claims for preferences will be rejected.

1 Proof of B-BBEE status level of contributor

Proof of B-BBEE status level of contributor shall be by means of

- the B-BBEE status level certificate issued by an authorized body or person;
- an affidavit as prescribed by the B-BBEE Codes of Good Practice; or
- any other requirement prescribed in terms of the Broad-Based Black Economic Empowerment Act

2 Tender preferences claimed

The scoring shall be as follows:

B-BBEE status level of contributor	Status level of a tenderer (tick relevant level)	Number of preference points	
		90/10 preference points system	80/20 preference points system
Form not completed or non-complaint contributor		0	0
Level 8 contributor		1	2
Level 7 contributor		2	4
Level 6 contributor		3	6
Level 5 contributor		4	8
Level 4 contributor		5	12
Level 3 contributor		6	14
Level 2 contributor		9	18
Level 1 contributor		10	20

4 Declaration

The tenderer declares that

a) the tendering entity is a level contributor as stated in the submitted proof of B-BBEE status level of a contributor as at the closing date for submissions

b) the tendering entity has been measured in terms of the following code (tick applicable box):

- Generic code of good practice
- Construction Sector Code
- Other – specify

.....
.....

c) the tendering entity confirms that it will only enter into a subcontract with the Employer's prior approval and is not permitted to subcontract more than 25% of the total of the prices of the contract to any other enterprise that does not have an equal or higher B-BBEE status level of contributor unless the contract is a subcontractor to an Exempted Micro Enterprises which has the capability to execute the contract.

d) the contents of the declarations made in terms of a) and b) above are within my knowledge and are to the best of my belief both true and correct

The undersigned, who warrants that he/she is duly authorized to do so on behalf of the tenderer, confirms that he/she understands the conditions under which such preferences are granted and confirms that the tenderer satisfies the conditions about the granting of tender preferences.

Signature:

Name:

Duly authorized to sign on behalf of:

Telephone:

Fax: Date:

Name of witness: Signature of witness:

- Note:** 1) Failure to complete the declaration will lead to the rejection of a claim for preference.
2) Supporting documentation of the abovementioned claim for preference must be submitted with the tender submission to be eligible for a preference

Proposed amendments and qualifications

The Tenderer should record any deviations or qualifications he may wish to make to the tender documents in this Returnable Schedule. Alternatively, a tenderer may state such deviations and qualifications in a cover letter to his tender and reference such a letter in this schedule.

The Tenderer's attention is drawn to clause 5.8 of SANS 10845-3 regarding the employer's handling of material deviations and qualifications.

Page	Clause or item	Proposal

Signed _____ Date _____

Name _____ Position _____

Tenderer _____

DECLARATION OF INTEREST

1. Any legal person, including persons employed by the state¹, or persons having a kinship with persons employed by the state, including a blood relationship, may make an offer or offers in terms of this invitation to bid (includes a price quotation, advertised competitive bid, limited bid or proposal). In view of possible allegations of favouritism, should the resulting bid, or part thereof, be awarded to persons employed by the state, or to persons connected with or related to them, it is required that the bidder or his/her authorised representative declare his/her position in relation to the evaluating/adjudicating authority where-

- the bidder is employed by the state; and/or
- the legal person on whose behalf the bidding document is signed, has a relationship with persons/a person who are/is involved in the evaluation and or adjudication of the bid(s), or where it is known that such a relationship exists between the person or persons for or on whose behalf the declarant acts and persons who are involved with the evaluation and or adjudication of the bid.

2. **In order to give effect to the above, the following questionnaire must be completed and submitted with the bid.**

2.1 Full Name of bidder or his or her representative:

2.2 Identity Number:

2.3 Position occupied in the Company (director, trustee, shareholder²):

2.4 Company Registration Number:

2.5 Tax Reference Number:

2.6 VAT Registration Number:

2.6.1 The names of all directors / trustees / shareholders / members, their individual identity numbers, tax reference numbers and, if applicable, employee / persal numbers must be indicated in paragraph 3 below.

¹"State" means –

- (a) any national or provincial department, national or provincial public entity or constitutional institution within the meaning of the Public Finance Management Act, 1999 (Act No. 1 of 1999);
- (b) any municipality or municipal entity;
- (c) provincial legislature;
- (d) national Assembly or the national Council of provinces; or
- (e) Parliament.

²"Shareholder" means a person who owns shares in the company and is actively involved in the management of the enterprise or business and exercises control over the enterprise.

2.7 Are you or any person connected with the bidder presently employed by the state? **YES / NO**

2.7.1 If so, furnish the following particulars:

Name of person / director / trustee / shareholder/ member:

Name of state institution at which you or the person connected to the bidder is employed :
Position occupied in the state institution:

Any other particulars:
.....
.....
.....

2.7.2 If you are presently employed by the state, did you obtain the appropriate authority to undertake remunerative work outside employment in the public sector? **YES / NO**

2.7.2.1 If yes, did you attached proof of such authority to the bid document? **YES / NO**

(Note: Failure to submit proof of such authority, where applicable, may result in the disqualification of the bid.

2.7.2.2 If no, furnish reasons for non-submission of such proof:
.....
.....
.....

2.8 Did you or your spouse, or any of the company's directors / trustees / shareholders / members or their spouses conduct business with the state in the previous twelve months? **YES / NO**

2.8.1 If so, furnish particulars:
.....
.....
.....

2.9 Do you, or any person connected with the bidder, have any relationship (family, friend, other) with a person employed by the state and who may be involved with the evaluation and or adjudication of this bid? **YES / NO**

2.9.1 If so, furnish particulars.
.....
.....
.....

2.10 Are you, or any person connected with the bidder, aware of any relationship (family, friend, other) between any other bidder and any person employed by the state who may be involved with the evaluation and or adjudication of this bid? **YES/NO**

2.10.1 If so, furnish particulars.

.....

2.11 Do you or any of the directors / trustees / shareholders / members of the company have any interest in any other related companies whether or not they are bidding for this contract? **YES/NO**

2.11.1 If so, furnish particulars:

3 Full details of directors / trustees / members / shareholders.

Full Name	Identity Number	Personal Reference Number	Tax Number	State Number / Employee Peral

4 DECLARATION

I, THE UNDERSIGNED (NAME).....

CERTIFY THAT THE INFORMATION FURNISHED IN PARAGRAPHS 2 and 3 ABOVE IS CORRECT.
I ACCEPT THAT THE STATE MAY REJECT THE BID OR ACT AGAINST ME IN TERMS OF
PARAGRAPH 23 OF THE GENERAL CONDITIONS OF CONTRACT SHOULD THIS DECLARATION
PROVE TO BE FALSE.

.....
Signature

.....
Date

.....
Position

.....
Name of bidder

SBD 6.1

PREFERENCE POINTS CLAIM FORM IN TERMS OF THE PREFERENTIAL PROCUREMENT REGULATIONS 2017

This preference form must form part of all bids invited. It contains general information and serves as a claim form for preference points for Broad-Based Black Economic Empowerment (B-BBEE) Status Level of Contribution

NB: BEFORE COMPLETING THIS FORM, BIDDERS MUST STUDY THE GENERAL CONDITIONS, DEFINITIONS AND DIRECTIVES APPLICABLE IN RESPECT OF B-BBEE, AS PRESCRIBED IN THE PREFERENTIAL PROCUREMENT REGULATIONS, 2017.

1. GENERAL CONDITIONS

1.1 The following preference point systems are applicable to all bids:

- the 80/20 system for requirements with a Rand value of up to R50 000 000 (all applicable taxes included); and
- the 90/10 system for requirements with a Rand value above R50 000 000 (all applicable taxes included).

- 1.2
- a) The value of this bid is estimated to exceed/not exceed R50 000 000 (all applicable taxes included) and therefore the.....preference point system shall be applicable; or
 - b) Either the 80/20 or 90/10 preference point system will be applicable to this tender (*delete whichever is not applicable for this tender*).

1.3 Points for this bid shall be awarded for:

- (a) Price; and
- (b) B-BBEE Status Level of Contributor.

1.4 The maximum points for this bid are allocated as follows:

	POINTS
PRICE	
B-BBEE STATUS LEVEL OF CONTRIBUTOR	
Total points for Price and B-BBEE must not exceed	100

1.5 Failure on the part of a bidder to submit proof of B-BBEE Status level of contributor together with the bid, will be interpreted to mean that preference points for B-BBEE status level of contribution are not claimed.

1.6 The purchaser reserves the right to require of a bidder, either before a bid is adjudicated or at any time subsequently, to substantiate any claim in regard to preferences, in any manner required by the purchaser.

2. DEFINITIONS

- (a) **“B-BBEE”** means broad-based black economic empowerment as defined in section 1 of the Broad-Based Black Economic Empowerment Act;
- (b) **“B-BBEE status level of contributor”** means the B-BBEE status of an entity in terms of a code of good practice on black economic empowerment, issued in terms of section 9(1) of the Broad-Based Black Economic Empowerment Act;
- (c) **“bid”** means a written offer in a prescribed or stipulated form in response to an invitation by an organ of state for the provision of goods or services, through price quotations, advertised competitive bidding processes or proposals;
- (d) **“Broad-Based Black Economic Empowerment Act”** means the Broad-Based Black Economic Empowerment Act, 2003 (Act No. 53 of 2003);
- (e) **“EME”** means an Exempted Micro Enterprise in terms of a code of good practice on black economic empowerment issued in terms of section 9 (1) of the Broad-Based Black Economic Empowerment Act;
- (f) **“functionality”** means the ability of a tenderer to provide goods or services in accordance with specifications as set out in the tender documents.
- (g) **“prices”** includes all applicable taxes less all unconditional discounts;
- (h) **“proof of B-BBEE status level of contributor”** means:
 - 1) B-BBEE Status level certificate issued by an authorized body or person;
 - 2) A sworn affidavit as prescribed by the B-BBEE Codes of Good Practice;
 - 3) Any other requirement prescribed in terms of the B-BBEE Act;
- (i) **“QSE”** means a qualifying small business enterprise in terms of a code of good practice on black economic empowerment issued in terms of section 9 (1) of the Broad-Based Black Economic Empowerment Act;
- (j) **“rand value”** means the total estimated value of a contract in Rand, calculated at the time of bid invitation, and includes all applicable taxes;

3. POINTS AWARDED FOR PRICE

3.1 THE 80/20 OR 90/10 PREFERENCE POINT SYSTEMS

A maximum of 80 or 90 points is allocated for price on the following basis:

80/20	or	90/10
$P_s = 80 \left(1 - \frac{P_t - P_{min}}{P_{min}} \right)$	or	$P_s = 90 \left(1 - \frac{P_t - P_{min}}{P_{min}} \right)$

Where

- P_s = Points scored for price of bid under consideration
- P_t = Price of bid under consideration
- P_{min} = Price of lowest acceptable bid

4. POINTS AWARDED FOR B-BBEE STATUS LEVEL OF CONTRIBUTOR

4.1 In terms of Regulation 6 (2) and 7 (2) of the Preferential Procurement Regulations, preference points must be awarded to a bidder for attaining the B-BBEE status level of contribution in accordance with the table below:

B-BBEE Status Level of Contributor	Number of points (90/10 system)	Number of points (80/20 system)
1	10	20
2	9	18
3	6	14
4	5	12
5	4	8
6	3	6
7	2	4
8	1	2
Non-compliant contributor	0	0

5. BID DECLARATION

5.1 Bidders who claim points in respect of B-BBEE Status Level of Contribution must complete the following:

6. B-BBEE STATUS LEVEL OF CONTRIBUTOR CLAIMED IN TERMS OF PARAGRAPHS 1.4 AND 4.1

6.1 B-BBEE Status Level of Contributor: . = (maximum of 10 or 20 points)

(Points claimed in respect of paragraph 7.1 must be in accordance with the table reflected in paragraph 4.1 and must be substantiated by relevant proof of B-BBEE status level of contributor.)

7. SUB-CONTRACTING

7.1 Will any portion of the contract be sub-contracted?

(Tick applicable box)

YES	<input type="checkbox"/>	NO	<input type="checkbox"/>
-----	--------------------------	----	--------------------------

7.1.1 If yes, indicate:

- i) What percentage of the contract will be subcontracted..... %
- ii) The name of the sub-contractor.....
- iii) The B-BBEE status level of the sub-contractor.....
- iv) Whether the sub-contractor is an EME or QSE

(Tick applicable box)

YES	<input type="checkbox"/>	NO	<input type="checkbox"/>
-----	--------------------------	----	--------------------------

v) Specify, by ticking the appropriate box, if subcontracting with an enterprise in terms of Preferential Procurement Regulations,2017:

Designated Group: An EME or QSE which is at last 51% owned by:	EME √	QSE √
Black people		
Black people who are youth		
Black people who are women		
Black people with disabilities		
Black people living in rural or underdeveloped areas or townships		
Cooperative owned by black people		
Black people who are military veterans		
OR		
Any EME		
Any QSE		

8. DECLARATION WITH REGARD TO COMPANY/FIRM

8.1 Name of company/firm:.....

8.2 VAT registration number:.....

8.3 Company registration number:.....

8.4 TYPE OF COMPANY/ FIRM

- Partnership/Joint Venture / Consortium
- One person business/sole propriety
- Close corporation
- Company
- (Pty) Limited

[TICK APPLICABLE BOX]

8.5 DESCRIBE PRINCIPAL BUSINESS ACTIVITIES

.....

8.6 COMPANY CLASSIFICATION

- Manufacturer
- Supplier
- Professional service provider
- Other service providers, e.g. transporter, etc.

[TICK APPLICABLE BOX]

8.7 Total number of years the company/firm has been in business:.....

8.8 I/we, the undersigned, who is / are duly authorised to do so on behalf of the company/firm, certify that the points claimed, based on the B-BBE status level of contributor indicated in paragraphs 1.4 and 6.1 of the foregoing certificate, qualifies the company/ firm for the preference(s) shown and I / we acknowledge that:

- i) The information furnished is true and correct;
- ii) The preference points claimed are in accordance with the General Conditions as indicated in paragraph 1 of this form;
- iii) In the event of a contract being awarded as a result of points claimed as shown in paragraphs 1.4 and 6.1, the contractor may be required to furnish documentary proof to the satisfaction of the purchaser that the claims are correct;
- iv) If the B-BBEE status level of contributor has been claimed or obtained on a fraudulent basis or any of the conditions of contract have not been fulfilled, the purchaser may, in addition to any other remedy it may have –
 - (a) disqualify the person from the bidding process;
 - (b) recover costs, losses or damages it has incurred or suffered as a result of that person’s conduct;
 - (c) cancel the contract and claim any damages which it has suffered as a result of having to make less favourable arrangements due to such cancellation;
 - (d) recommend that the bidder or contractor, its shareholders and directors, or only the shareholders and directors who acted on a fraudulent basis, be restricted by the National Treasury from obtaining business from any organ of state for a period not exceeding 10 years, after the *audi alteram partem* (hear the other side) rule has been applied; and
 - (e) forward the matter for criminal prosecution.

WITNESSES

1.

2.

.....
SIGNATURE(S) OF BIDDERS(S)

DATE:

ADDRESS

.....

.....

DECLARATION CERTIFICATE FOR LOCAL PRODUCTION AND CONTENT FOR DESIGNATED SECTORS

This Standard Bidding Document (SBD) must form part of all bids invited. It contains general information and serves as a declaration form for local content (local production and local content are used interchangeably).

Before completing this declaration, bidders must study the General Conditions, Definitions, Directives applicable in respect of Local Content as prescribed in the Preferential Procurement Regulations, 2017, the South African Bureau of Standards (SABS) approved technical specification number SATS 1286:2011 (Edition 1) and the Guidance on the Calculation of Local Content together with the Local Content Declaration Templates [Annex C (Local Content Declaration: Summary Schedule), D (Imported Content Declaration: Supporting Schedule to Annex C) and E (Local Content Declaration: Supporting Schedule to Annex C)].

1. General Conditions

- 1.1. Preferential Procurement Regulations, 2017 (Regulation 8) make provision for the promotion of local production and content.
- 1.2. Regulation 8.(2) prescribes that in the case of designated sectors, organs of state must advertise such tenders with the specific bidding condition that only locally produced or manufactured goods, with a stipulated minimum threshold for local production and content will be considered.
- 1.3. Where necessary, for tenders referred to in paragraph 1.2 above, a two stage bidding process may be followed, where the first stage involves a minimum threshold for local production and content and the second stage price and B-BBEE.
- 1.4. A person awarded a contract in relation to a designated sector, may not sub-contract in such a manner that the local production and content of the overall value of the contract is reduced to below the stipulated minimum threshold.
- 1.5. The local content (LC) expressed as a percentage of the bid price must be calculated in accordance with the SABS approved technical specification number SATS 1286: 2011 as follows:

$$LC = [1 - x / y] * 100$$

Where

x is the imported content in Rand

y is the bid price in Rand excluding value added tax (VAT)

Prices referred to in the determination of x must be converted to Rand (ZAR) by using the exchange rate published by South African Reserve Bank (SARB) at 12:00 on the date of advertisement of the bid as indicated in paragraph 4.1 below.

The SABS approved technical specification number SATS 1286:2011 is accessible on [http://www.thedti.gov.za/industrial development/ip. jsp](http://www.thedti.gov.za/industrial%20development/ip.jsp) at no cost.

1.6. A bid may be disqualified if this Declaration Certificate and the Annex C (Local Content Declaration: Summary Schedule) are not submitted as part of the bid documentation;

2. The stipulated minimum threshold(s) for local production and content (refer to Annex A of SATS 1286:2011) for this bid is/are as follows:

<u>Description of services, works or goods</u>	<u>Stipulated minimum threshold</u>
_____	_____ %
_____	_____ %
_____	_____ %

3. Does any portion of the goods or services offered have any imported content?

(Tick applicable box)

YES	<input type="checkbox"/>	NO	<input type="checkbox"/>
-----	--------------------------	----	--------------------------

3..1 If yes, the rate(s) of exchange to be used in this bid to calculate the local content as prescribed in paragraph 1.5 of the general conditions must be the rate(s) published by SARB for the specific currency at 12:00 on the date of advertisement of the bid.

The relevant rates of exchange information is accessible on www.reservebank.co.za

Indicate the rate(s) of exchange against the appropriate currency in the table below (refer to Annex A of SATS 1286:2011):

Currency	Rates of exchange
US Dollar	
Pound Sterling	
Euro	
Yen	
Other	

NB: Bidders must submit proof of the SARB rate (s) of exchange used.

3. Where, after the award of a bid, challenges are experienced in meeting the stipulated minimum threshold for local content the dti must be informed accordingly in order for the dti to verify and in consultation with the AO/AA provide directives in this regard.

LOCAL CONTENT DECLARATION
(REFER TO ANNEX B OF SATS 1286:2011)

LOCAL CONTENT DECLARATION BY CHIEF FINANCIAL OFFICER OR OTHER LEGALLY RESPONSIBLE PERSON NOMINATED IN WRITING BY THE CHIEF EXECUTIVE OR SENIOR MEMBER/PERSON WITH MANAGEMENT RESPONSIBILITY (CLOSE CORPORATION, PARTNERSHIP OR INDIVIDUAL)

IN RESPECT OF BID NO.

ISSUED BY: (Procurement Authority / Name of Institution):

NB

- 1 The obligation to complete, duly sign and submit this declaration cannot be transferred to an external authorized representative, auditor or any other third party acting on behalf of the bidder.
- 2 Guidance on the Calculation of Local Content together with Local Content Declaration Templates (Annex C, D and E) is accessible on <http://www.thdti.gov.za/industrialdevelopment/ip.jsp>. Bidders should first complete Declaration D. After completing Declaration D, bidders should complete Declaration E and then consolidate the information on Declaration C. **Declaration C should be submitted with the bid documentation at the closing date and time of the bid in order to substantiate the declaration made in paragraph (c) below.** Declarations D and E should be kept by the bidders for verification purposes for a period of at least 5 years. The successful bidder is required to continuously update Declarations C, D and E with the actual values for the duration of the contract.

I, the undersigned,(full names),
 do hereby declare, in my capacity as
 of(name of bidder
 entity), the following:

- (a) The facts contained herein are within my own personal knowledge.
- (b) I have satisfied myself that:
 - (i) the goods/services/works to be delivered in terms of the above-specified bid comply with the minimum local content requirements as specified in the bid, and as measured in terms of SATS 1286:2011; and
- (c) The local content percentage (%) indicated below has been calculated using the formula given in clause 3 of SATS 1286:2011, the rates of exchange indicated in paragraph 4.1 above and the information contained in Declaration D and E which has been consolidated in Declaration C:

Bid price, excluding VAT (y)	R
Imported content (x), as calculated in terms of SATS 1286:2011	R
Stipulated minimum threshold for local content (paragraph 3 above)	
Local content %, as calculated in terms of SATS 1286:2011	

If the bid is for more than one product, the local content percentages for each product contained in Declaration C shall be used instead of the table above. The local content percentages for each product has been calculated using the formula given in clause 3 of SATS 1286:2011, the rates of exchange indicated in paragraph 4.1 above and the information contained in Declaration D and E.

- (d) I accept that the Procurement Authority / Institution has the right to request that the local content be verified in terms of the requirements of SATS 1286:2011.
- (e) I understand that the awarding of the bid is dependent on the accuracy of the information furnished in this application. I also understand that the submission of incorrect data, or data that are not verifiable as described in SATS 1286:2011, may result in the Procurement Authority / Institution imposing any or all of the remedies as provided for in Regulation 14 of the Preferential Procurement Regulations, 2017 promulgated under the Preferential Policy Framework Act (PPPFA), 2000 (Act No. 5 of 2000).

SIGNATURE: _____

DATE: _____

WITNESS No. 1 _____

DATE: _____

WITNESS No. 2 _____

DATE: _____

GUIDANCE DOCUMENT FOR THE CALCULATION OF LOCAL CONTENT

1. DEFINITIONS

Unless explicitly provided in this guideline, the definitions given in SATS 1286:2011 apply.

2. GENERAL

2.1. Introduction

This guideline provides tenderers with a detailed description of how to calculate local content of products (goods, services and works) by components/material/services and enables them to keep an updated record for verification requirements as per the SATS 1286:2011 Annexure A and B.

The guideline consists of two parts, namely:

- a written guideline; and
- three declarations that must be completed:
 - Declaration C: “Local Content Declaration – Summary Schedule” (see Annexure C);
 - Declaration D: “Imported Content Declaration – Supporting Schedule to Annex C” (see Annexure D); and
 - Declaration E: “Local Content Declaration – Supporting Schedule to Annex C” (see Annexure E).

The guidelines and declarations should be used by tenderers when preparing a tender. A tenderer must complete Declarations D and E, and consolidate the information on Declaration C.

Annexure C must be submitted with the tender by the closing date and time as determined by the Tender Authority. The Tender Authority reserves the right to request that Declarations D and E also be submitted.

If the tender is successful, the tenderer must continuously update Declarations C, D and E with actual values for the duration of the contract.

NOTE:

Annexure A is a note to the purchaser in SATS 1286:2011; and
Annexure B is the Local Content Declaration IN SATS 1286:2011.

2.2. What is local content?

According to SATS 1286:2011, the local content of a product is the tender price less the value of imported content, expressed as a percentage. It is, therefore, necessary to first compute the imported value of a product to determine the local content of a product.

2.3. Categories: Imported and Local Content

The tenderer must differentiate between imported content and local content. Imported content of a product by components/material/services is separated into two categories, namely:

- products imported directly by the tenderer; and
- products imported by a third party and supplied to the tenderer.

2.3.1. Imported Content

Identify the imported content, if any, by value for products by component/material/services. In the case of components/materials/services sourced from a South African manufacturer, agent, supplier or subcontractor (i.e. third party), obtain that information and Declaration D from the third party.

Calculate the imported content of components/materials/services to be used in the manufacture of the total quantity of the products for which the tender is to be submitted.

As stated in clause 3.2.4 of SATS 1286:2011: "If information on the origin of components, parts or materials is not available, it will be deemed to be imported content."

2.3.1.1. Imported directly by the tenderer:

When the tenderer import products directly, the onus is on the tenderer to provide evidence of any components/materials/services that were procured from a non-domestic source. The evidence should be verifiable and pertain to the tender as a whole. Typical evidence will include commercial invoices, bills of entry, etc.

When the tenderer procures imported services such as project management, design, testing, marketing, etc. and makes royalty and lease payments, such payments relating to the tender must be included when calculating imported content.

2.3.1.2. Imported by a third party and supplied to the tenderer:

When the tenderer supplies components/material/services that are imported by any third party (for example, a domestic manufacturer, agent, supplier or subcontractor in the supply chain), the onus is on the tenderer to obtain verifiable evidence from the third party.

The tenderer must obtain Declaration D from all third parties for the related tender. The third party must be requested by the tenderer to continuously update Declaration D. Typical evidence of imported content will include commercial invoices, bills of entry etc.

When a third party procures imported services such as project management, design, testing, marketing etc. and makes royalty and lease payments, such payments relating to the tender must be included when calculating imported content.

2.3.1.3. Exempt Imported Content:

Exemptions, if any, are granted by the Department of Trade and Industry (the dti). Evidence of the exemptions must be provided and included in Annexure D.

2.3.2. Local Content

Identify and calculate the local content, by value for products by components/materials/services to be used in the manufacture of the total quantity of the products.

TREASURY DESIGNATED SECTOR

Steel Construction Material							
Section	Bill no	Page no	Item no	Description	Unit	Qty	Local content Threshold
				Concrete, Formwork & Reinforcement			
2				Steel bar reinforcement of various diameters (100kg/m3)	t		100%
				Mesh/fabric reinforcement			
2				Ref 193 mesh steel reinforcement in concrete walls, etc.	m2		100%
				Type 193 fabric reinforcement in concrete bottoms	m2		100%
2				Type 617 fabric reinforcement in concrete bottoms	m2		100%
				Brickwork reinforcement(Foundations)			
2				75mm Wide reinforcement built in horizontally	m		100%
2				150mm Wide reinforcement built in horizontally	m		100%
2				30 x 1,6mm Roof tie 1,5m long with one end fixed to timber and other end built into brickwork	No		100%
				Brickwork reinforcement(Superstructure)			
2				75mm Wide reinforcement	m		100%
2				150mm Wide reinforcement	m		100%
				Cement (Concrete, Formwork & Reinforcement)			
2				Cem I	t		100%
2				Cem II	t		100%
2				Cem IV	t		100%
2				Cem V	t		100%
				Masonry			
2				Masonry cement	t		100%

BID NO: LDPWRI-B/20151

Roof coverings						
2				Roof covering with 25 degrees pitch	m2	100%
2				Ridge capping 550mm girth	m	100%
2				Valley cappings 550mm girth	m	100%
2				Hip capping 550mm girth	m	100%
2				Flashings	M	100%

Plates-Push Plates and Kicking Plates (Ironmongery)						
2				DSS4 'Wheelchair' or similar pictogram on 76mm diameter stainless steel plate	No	100%
2				DSS2 'Female' or similar pictogram on 76mm diameter stainless steel plate	No	100%
2				DSS1 'Male' or similar pictogram on 76mm diameter stainless steel plate	No	100%
Fabricated structural steel(Ironmongery)						
2				Overhead surface mounted type door closer with aluminium casing	No	100%
2				Approved toilet paper dispenser fixed against wall as per manufacturers specifications	No	100%
2				425792 'Kim dry' towel dispenser rail fixed against wall as per manufacturers spec	No	100%
2				100mm x 3mm x 4.53kg/m circular hollow section column	t	100%
2				150 x 150 x 10mm Base plates including 4 no . holes to suite m16 bolts. bolts included	No	100%
2				150 x 150 x 10mm Top connector plates including 2 no . holes to suite m16 bolts. bolts included	No	100%
2				32mm Grab rail 700mm long with two 80mm return ends bolted	No	100%
Fabricated structural steel(Metal work)						
2				2100 x 900mm Steel gate comprising of 75 x 50 x 2mm square tubing outer frame and 20 x 20mm square tubing verticals at 120mm centres	No	100%
2				Mutual DS3 CAT2 strongroom door and frame 775 x 1875mm high overall with a mass of 380kg	No	100%

Steel door Frames						
2				Frame for door 813 x 2032mm high	No	100%
2				Frame for door 813 x 2032mm high and fixed fanlight 305mm high	No	100%
2				Frame for door 813 x 2 032mm high	No	100%
2				Frame for door 813 x 2032mm high and fixed fanlight 305mm high	No	100%
2				Frame for door 914 x 2 032mm high	No	100%
2				Frame for door 1 511 x 2 032mm high	No	100%
Steel windows						
2				Window type NE1, 533 x 654mm high	No	100%
2				Window type NCT1S, 533 X 949mm high	No	100%
2				Window type ND2, 1022 x 1245mm high	No	100%
2				Window type ND4, 1511 x 1245mm high	No	100%
2				Window type NE8, 1022 x 654mm high	No	100%
2				Window type NG2, 1022 x 359mm high	No	100%
Gutters, Downpipe and Lauders						
2				100 x 75mm Rainwater pipes	m	100%
2				Extra over gutter for stopped end	No	100%
2				Extra over gutter for angle	No	100%
2				Extra over gutter for outlet for 75 x 75mm pipe	No	100%
2				75 x 75mm diameter rainwater pipes fixed to columns, etc	m	100%
2				Extra over rainwater pipe for bend	No	100%
2				Extra over rainwater pipe for eaves or plinth offset	No	100%
2				Extra over rainwater pipes for shoe	No	100%

Plastic pipes							
Section	Bill no	Page no	Item no	Description	Unit	Qty	Local content Threshold
	PVC pipes						
2				50mm Pipes fixed to walls, etc.	m		100%
2				110mm Pipes fixed to walls, etc.	m		100%
2				110mm Pipes laid in and including trenches not exceeding 1m deep	m		100%
2				50mm Bend	No		100%
2				50mm Access bend	No		100%
2				110mm Bend	No		100%
2				110mm Tee junction	No		100%
2				110 x 50 mm Reducing junction	No		100%

Valves products and acutors							
Section	Bill no	Page no	Item no	Description	Unit	Qty	Local content Threshold
	Taps&Valves						
2				15mm Chromium plated full way ballcock shut-off control valve with screw type control	No		100%
2				15mm Brass stopcock	No		100%
2				15mm Chromium sink mixer (Code 266/04/10)	No		100%
2				Selene 953, pillartap	No		100%

3. ANNEXURE C

3.1. Guidelines for completing Annexure C: Local Content Declaration – Summary Schedule

Note: The paragraph numbers correspond to the numbers in Annexure C.

C1. Tender Number

Supply the tender number that is specified on the specific tender documentation.

C2. Tender description

Supply the tender description that is specified on the specific tender documentation.

C3. Designated products

Supply the details of the products that are designated in terms of this tender (i.e. buses).

C4. Tender Authority

Supply the name of the tender authority.

C5. Tendering Entity name

Provide the tendering entity name (for example, DPWRT Builders (Pty) Ltd).

C6. Tender Exchange Rate

Provide the exchange rate used for this tender, as per the Standard Bidding Document (SBD) and Standard Bidding Document (SBD) 6.2.

C7. Specified local content %

Provide the specified minimum local content requirement for the tender (i.e. 80%), as per the Standard Bidding Document (SBD) and Municipal Bidding Document (MDB) 6.2.

C8. Tender item number

Provide the tender item number(s) of the products that have a local content requirement as per the tender specification.

C9. List of items

Provide a list of the item(s) corresponding with the tender item number. This may be a short description or a brand name.

Calculation of local content

C10. Tender price

Provide the unit tender price of each item excluding VAT.

C11. Exempted imported content

Provide the ZAR value of the exempted imported content for each item, if applicable. These value(s) must correspond with the value(s) of column D16 on Annexure D.

C12. Tender value net of exempted imported content

Provide the net tender value of the item, if applicable, by deducting the exempted imported content (C11) from the tender price (C10).

C13. Imported value

Provide the ZAR value of the items' imported content.

C14. Local value

Provide the local value of the item by deducting the Imported value (C13) from the net tender value (C12).

C15. Local content percentage (per item)

Provide the local content percentage of the item(s) by dividing the local value (C14) by the net tender value (C12) as per the local content formula in SATS 1286.

Tender Summary

C16. Tender quantity

Provide the tender quantity for each item number as per the tender specification.

C17. Total tender value

Provide the total tender value by multiplying the tender quantity (C16) by the tender price (C10).

C18. Total exempted imported content

Provide the total exempted imported content by multiplying the tender quantity (C16) by the exempted imported content (C11). These values must correspond with the values of column D18 on Annexure D.

C19. Total imported content

Provide the total imported content of each item by multiplying the tender quantity (C16) by the imported value (C13).

C20. Total tender value

Total tender value is the sum of the values in column C17.

C21. Total exempted imported content

Total exempted imported content is the sum of the values in column C18. This value must correspond with the value of D19 on Annexure D.

C22. Total tender value net of exempted imported content

The total tender value net of exempt imported content is the total tender value (C20) less the total exempted imported content (C21).

C23. Total imported content

Total imported content is the sum of the values in column C19. This value must correspond with the value of D53 on Annexure D.

C24. Total local content

Total local content is the total tender value net of exempted imported content (C22) less the total imported content (C23). This value must correspond with the value of E13 on Annexure E.

C25. Average local content percentage of tender

The average local content percentage of tender is calculated by dividing total local content (C24) by the total tender value net of exempted imported content (C22).

4. ANNEXURE D

4.1. Guidelines for completing Annexure D: “Imported Content Declaration – Supporting Schedule to Annexure C”

Note: The paragraph numbers correspond to the numbers in Annexure D.

D1. Tender number

Supply the tender number that is specified on the specific tender documentation.

D2. Tender description

Supply the tender description that is specified on the specific tender documentation.

D3. Designated products

Supply the details of the products that are designated in terms of this tender (i.e. buses).

D4. Tender authority

Supply the name of the tender authority.

D5. Tendering entity name

Provide the tendering entity name (i.e. DPWRT Builders (Pty) Ltd).

D6. Tender exchange rate

Provide the exchange rate used for this tender, as per the Standard Bidding Document (SBD) and Standard Bidding Document (SBD) 6.2.

Table A. Exempted Imported Content

D7. Tender item number

Provide the tender item number(s) of the product(s) that have imported content.

D8. Description of imported content

Provide a list of the exempted imported product(s), if any, as specified in the tender.

D9. Local supplier

Provide the name of the local supplier(s) supplying the imported product(s).

D10. Overseas supplier

Provide the name(s) of the overseas supplier(s) supplying the exempted imported product(s).

D11. Imported value as per commercial invoice

Provide the foreign currency value of the exempted imported product(s) disclosed in the commercial invoice accepted by the South African Revenue Service (SARS).

D12. Tender exchange rate

Provide the exchange rate used for this tender as per the Standard Bidding Document (SBD) and Standard Bidding Document (SBD) 6.2.

D13. Local value of imports

Convert the value of the exempted imported content as per commercial invoice (D11) into the ZAR value by using the tender exchange rate (D12) disclosed in the tender documentation.

D14. Freight costs to port of entry

Provide the freight costs to the South African Port of the exempted imported item.

D15. All locally incurred landing costs and duties

Provide all landing costs including customs and excise duty for the exempted imported product(s) as stipulated in the SATS 1286:2011.

D16. Total landed costs excluding VAT

Provide the total landed costs (excluding VAT) for each item imported by adding the corresponding item values in columns D13, D14 and D15. These values must be transferred to column C11 on Annexure C.

D17. Tender quantity

Provide the tender quantity of the exempted imported products as per the tender specification.

D18. Exempted imported value

Provide the imported value for each of the exempted imported product(s) by multiplying the total landed cost (excl. VAT) (D16) by the tender quantity (D17). The values in column D18 must correspond with the values of column C18 of Annexure C.

D19. Total exempted imported value

The total exempted imported value is the sum of the values in column D18. This total must correspond with the value of C21 on Annexure C.

Table B. Imported Directly By Tenderer

D20. Tender item numbers

Provide the tender item number(s) of the product(s) that have imported content.

D21. Description of imported content:

Provide a list of the product(s) imported directly by tender as specified in the tender documentation.

D22. Unit of measure

Provide the unit of measure for the product(s) imported directly by the tenderer.

D23. Overseas supplier

Provide the name(s) of the overseas supplier(s) supplying the imported product(s).

D24. Imported value as per commercial Invoice

Provide the foreign currency value of the product(s) imported directly by tenderer disclosed in the commercial invoice accepted by the South African Revenue Service (SARS).

D25. Tender rate of exchange

Provide the exchange rate used for this tender as per the Standard Bidding Document (SBD) and Standard Bidding Document (SBD) 6.2.

D26. Local value of imports

Convert the value of the product(s) imported directly by the tenderer as per commercial invoice (D24) into the ZAR value by using the tender exchange rate (D25) disclosed in the tender documentation.

D27. Freight costs to port of entry

Provide the freight costs to the South African Port of the product(s) imported directly by the tenderer.

D28. All locally incurred landing costs and duties

Provide all landing costs including customs and excise duty for the product(s) imported directly by the tenderer as stipulated in the SATS 1286:2011.

D29. Total landed costs excluding VAT

Provide the total landed costs (excluding VAT) for each item imported directly by the tenderer by adding the corresponding item values in columns D26, D27 and D28.

D30. Tender quantity

Provide the tender quantity of the product(s) imported directly by the tenderer as per the tender specification.

D31. Total imported value

Provide the total imported value for each of the product(s) imported directly by the tenderer by multiplying the total landed cost (excl. VAT) (D29) by the tender quantity (D30).

D32. Total imported value by tenderer

The total value of imports by the tenderer is the sum of the values in column D31.

Table C. Imported by Third Party and Supplied to the Tenderer

D33. Description of imported content

Provide a list of the product(s) imported by the third party and supplied to the tenderer as specified in the tender documentation.

D34. Unit of measure

Provide the unit of measure for the product(s) imported by the third party and supplied to tenderer as disclosed in the commercial invoice.

D35. Local supplier

Provide the name of the local supplier(s) supplying the imported product(s).

D36. Overseas supplier

Provide the name(s) of the overseas supplier(s) supplying the imported products.

D37. Imported value as per commercial invoice

Provide the foreign currency value of the product(s) imported by the third party and supplied to the tenderer disclosed in the commercial invoice accepted by SARS.

D38. Tender rate of exchange

Provide the exchange rate used for this tender as per the Standard Bidding Document (SBD) and Standard Bidding Document (SBD) 6.2.

D39. Local value of imports

Convert the value of the product(s) imported by the third party as per commercial invoice (D37) into the ZAR value by using the tender exchange rate (D38) disclosed in the tender documentation.

D40. Freight costs to port of entry

Provide the freight costs to the South African Port of the product(s) imported by third party and supplied to the tenderer.

D41. All locally incurred landing costs and duties

Provide all landing costs including customs and excise duty for the product(s) imported by third party and supplied to the tenderer as stipulated in the SATS 1286:2011.

D42. Total landed costs excluding VAT

Provide the total landed costs (excluding VAT) for each product imported by third party and supplied to the tenderer by adding the corresponding item values in columns D39, D40 and D41.

D43. Quantity imported

Provide the quantity of each product(s) imported by third party and supplied to the tenderer for the tender.

D44. Total imported value

Provide the total imported value of the product(s) imported by third party and supplied to the tenderer by multiplying the total landed cost (D42) by the quantity imported (D43).

D45. Total imported value by third party

The total imported value from the third party is the sum of the values in column D44.

Table D. Other Foreign Currency Payments

D46. Type of payment

Provide the type of foreign currency payment. (i.e. royalty payment for use of patent, annual licence fee, etc.).

D47. Local supplier making the payment

Provide the name of the local supplier making the payment.

D48. Overseas beneficiary

Provide the name of the overseas beneficiary.

D49. Foreign currency value paid

Provide the value of the listed payment(s) in their foreign currency.

D50. Tender rate of exchange

Provide the exchange rate used for this tender as per the Standard Bidding Document (SBD) and Standard Bidding Document (SBD) 6.2.

D51. Local value of payments

Provide the local value of each payment by multiplying the foreign currency value paid (D49) by the tender rate of exchange (D50).

D52. Total of foreign currency payments declared by tenderer and/or third party

The total of foreign currency payments declared by tenderer and/or a third party is the sum of the values in column D51.

D53. Total of imported content and foreign currency payment

The total imported content and foreign currency payment is the sum of the values in column D32, D45 and D52. This value must correspond with the value of C23 on Annexure C.

5. ANNEXURE E

5.1. Guidelines to completing Annexure E: “Local Content Declaration-Supporting Schedule to Annexure C”

The paragraph numbers correspond to the numbers in Annexure E

E1. Tender number

Supply the tender number that is specified on the specific tender documentation.

E2. Tender description

Supply the tender description that is specified on the specific tender documentation.

E3. Designated products

Supply the details of the products that are designated in terms of this tender (for example, buses/canned vegetables).

E4. Tender authority

Supply the name of the tender authority.

E5. Tendering entity name

Provide the tendering entity name (for example, DPWRT Builders (Pty) Ltd) Ltd).

Local Goods, Services and Works

E6. Description of items purchased

Provide a description of the items purchased locally in the space provided.

E7. Local supplier

Provide the name of the local supplier that corresponds to the item listed in column E6.

E8. Value

Provide the total value of the item purchased in column E6.

E9. Total local products (Goods, Services and Works)

Total local products (goods, services and works) is the sum of the values in E8.

E10. Manpower costs:

Provide the total of all the labour costs accruing only to the tenderer (i.e. not the suppliers to tenderer).

E11. Factory overheads:

Provide the total of all the factory overheads including rental, depreciation and amortisation for local and imported capital goods, utility costs and consumables. (Consumables are goods used by individuals and businesses that must be replaced regularly because they wear out or are used up. Consumables can also be defined as the components of an end product that are used up or permanently altered in the process of manufacturing, such as basic chemicals.)

E12. Administration overheads and mark-up:

Provide the total of all the administration overheads, including marketing, insurance, financing, interest and mark-up costs.

E13. Total local content:

The total local content is the sum of the values of E9, E10, E11 and E12. This total must correspond with C24 of Annexure C.

Annex C

Local Content Declaration - Summary Schedule

(C1) Tender No. LDPWRI-B/20151
 (C2) Tender description: CONSTRUCTION OF THE NEW VLEIFONTEIN LIBRARY
 (C3) Designated product(s) STEEL PRODUCTS AND COMPONENTS FOR CONSTRUCTION
 (C4) Tender Authority:
 (C5) Tendering Entity name: VLEIFONTEIN LIBRARY
 (C6) Tender Exchange Rate: Pula EU GBP
 (C7) Specified local content %

Note: VAT to be excluded from all calculations

Calculation of local content

Tender item no's	List of items	Tender price - each (excl VAT)	Exempted imported value	Tender value net of exempted imported content	Imported value	Local value	Local content % (per item)	Tender Qty	Total tender value	Total exempted imported content	Total Imported content
(C8)	(C9)	(C10)	(C11)	(C12)	(C13)	(C14)	(C15)	(C16)	(C17)	(C18)	(C19)
2-2-30-13	Steel bar reinforcement of various diameters (100kg/m3)							6.24			
2-2-30-14	Ref 193 mesh steel reinforcement in concrete walls, etc							623			
2-14-62-43	Type 193 fabric reinforcement in concrete bottoms							1			
2-14-62-44	Type 617 fabric reinforcement in concrete bottoms							1			
2-3-32-4	75mm Wide reinforcement built in horizontally							615			
2-3-32-5	150mm Wide reinforcement built in horizontally							1 876			
2-3-32-10	30 x 1,6mm Roof tie 1,5m long with one end fixed to timber and other end built into brickwork							160			

(C20) Total tender value R 0

(C21) Total Exempt imported content R 0

(C22) Total Tender value net of exempt imported content R 0

(C23) Total Imported content R 0

(C24) Total local content R 0

(C25) Average local content % of tender

Signature of tenderer from Annex B

Date: _____

Annex C

Local Content Declaration - Summary Schedule

(C1) Tender No. LDPWRI-B/20151

(C2) Tender description: CONSTRUCTION OF THE NEW VLEIFONTEIN LIBRARY

(C3) Designated product(s) STEEL PRODUCTS AND COMPONENTS FOR CONSTRUCTION

(C4) Tender Authority:

(C5) Tendering Entity name: VLEIFONTEIN LIBRARY

(C6) Tender Exchange Rate: Pula EU GBP

(C7) Specified local content %

Note: VAT to be excluded from all calculations

Calculation of local content								Tender summary			
Tender item no's	List of items	Tender price - each (excl VAT)	Exempted imported value	Tender value net of exempted imported content	Imported value	Local value	Local content % (per item)	Tender Qty	Total tender value	Total exempted imported content	Total Imported content
(C8)	(C9)	(C10)	(C11)	(C12)	(C13)	(C14)	(C15)	(C16)	(C17)	(C18)	(C19)
2-3-33-11	75mm Wide reinforcement							893			
2-3-33-12	150mm Wide reinforcement							1 915			
2-5-39-1	Roof covering with 25 degrees pitch							776			
2-5-39-2	Ridge capping 550mm girth							69			
2-5-39-3	Valley cappings 550mm girth							18			
2-5-39-4	Hip capping 550mm girth							27			
2-5-39-5	Flashings							1			
2-9-49-4	DSS4 'Wheelchair' or similiar pictogram on 76mm diameter stainless steel plate							2			
2-9-49-5	DSS2 'Female' or similiar pictogram on 76mm diameter stainless steel plate							2			
2-9-49-6	DSS1 'Male' or similiar pictogram on 76mm diameter stainless steel plate							3			
2-9-49-9	Overhead surface mounted type door closer with aluminium casing							8			
2-9-49-11	Approved toilet paper dispenser fixed against wall as per manufacturers specifications							7			

(C20) Total tender value R 0

(C21) Total Exempt imported content R 0

(C22) Total Tender value net of exempt imported content R 0

(C23) Total Imported content R 0

(C24) Total local content R 0

(C25) Average local content % of tender

Signature of tenderer from Annex B

Date: _____

Annex C

Local Content Declaration - Summary Schedule

(C1) **Tender No.** LDPWRI-B/20151

(C2) **Tender description:** CONSTRUCTION OF THE NEW VLEIFONTEIN LIBRARY

(C3) **Designated product(s)** STEEL PRODUCTS AND COMPONENTS FOR CONSTRUCTION

(C4) **Tender Authority:**

(C5) **Tendering Entity name:** VLEIFONTEIN LIBRARY

(C6) **Tender Exchange Rate:** Pula EU GBP

(C7) **Specified local content %**

Note: VAT to be excluded from all calculations

		Calculation of local content									
Tender item no's	List of items	Tender price - each (excl VAT)	Exempted imported value	Tender value net of exempted imported content	Imported value	Local value	Local content % (per item)	Tender Qty	Total tender value	Total exempted imported content	Total Imported content
(C8)	(C9)	(C10)	(C11)	(C12)	(C13)	(C14)	(C15)	(C16)	(C17)	(C18)	(C19)
2-9-49-12	425792 'Kim dry' towel dispenser rail fixed against wall as per manufacturers spec							7			
2-10-51-1	100mm x 3mm x 4.53kg/m circular hollow section column							0.03			
2-10-51-2	150 x 150 x 10mm Base plates including 4 no . holes to suite m16 bolts. bolts included							2			
2-10-51-3	150 x 150 x 10mm Top connector plates including 2 no . holes to suite m16 bolts. bolts included							2			
2-11-52-1	32mm Grab rail 700mm long with two 80mm return ends bolted							4			
2-11-52-2	2100 x 900mm Steel gate comprising of 75 x 50 x 2mm square tubing outer frame and 20 x 20mm							5			
2-11-53-9	Mutual DS3 CAT2 strongroom door and frame 775 x 1							2			
2-11-53-3	Frame for door 813 x 2032mm high							6			
2-11-53-4	Frame for door 813 x 2032mm high and fixed fanlight 305mm high							10			
2-11-53-5	Frame for door 813 x 2 032mm high							8			
2-11-53-6	Frame for door 813 x 2032mm high and fixed fanlight 305mm high							2			
2-11-53-7	Frame for door 914 x 2 032mm high							2			

(C20) Total tender value R 0

(C21) Total Exempt imported content R 0

(C22) Total Tender value net of exempt imported content R 0

(C23) Total Imported content R 0

(C24) Total local content R 0

(C25) Average local content % of tender

Signature of tenderer from Annex B

Date: _____

Annex C

Local Content Declaration - Summary Schedule

(C1) Tender No. LDPWRI-B/20151

(C2) Tender description: CONSTRUCTION OF THE NEW VLEIFONTEIN LIBRARY

(C3) Designated product(s) STEEL PRODUCTS AND COMPONENTS FOR CONSTRUCTION

(C4) Tender Authority:

(C5) Tendering Entity name: VLEIFONTEIN LIBRARY

(C6) Tender Exchange Rate: Pula EU GBP

(C7) Specified local content %

Note: VAT to be excluded from all calculations

Calculation of local content											
Tender item no's	List of items	Tender price - each (excl VAT)	Exempted imported value	Tender value net of exempted imported content	Imported value	Local value	Local content % (per item)	Tender Qty	Total tender value	Total exempted imported content	Total Imported content
(C8)	(C9)	(C10)	(C11)	(C12)	(C13)	(C14)	(C15)	(C16)	(C17)	(C18)	(C19)
2-11-53-8	Frame for door 1 511 x 2 032mm high							1			
2-11-53-10	Window type NE1, 533 x 654mm high							8			
2-11-53-11	Window type NCT1S, 533 X 949mm high							3			
2-11-53-	Window type ND2, 1022 x 1245mm high							17			
2-11-53-12	Window type ND4, 1511 x 1245mm high							8			
2-11-53-13	Window type NE8, 1022 x 654mm high							6			
2-11-53-14	Window type NG2, 1022 x 359mm high							6			
2-14-58-1	100 x 75mm Rainwater pipes							159			
2-14-58-2	Extra over gutter for stopped end							2			
2-14-58-3	Extra over gutter for angle							2			
2-14-58-4	Extra over gutter for outlet for 75 x 75mm pipe							13			

(C20) Total tender value R 0

(C21) Total Exempt imported content R 0

(C22) Total Tender value net of exempt imported content R 0

(C23) Total Imported content R 0

(C24) Total local content R 0

(C25) Average local content % of tender

Signature of tenderer from Annex B

Date: _____

Annex C

Local Content Declaration - Summary Schedule

(C1) **Tender No.** LDPWRI-B/20151

(C2) **Tender description:** CONSTRUCTION OF THE NEW VLEIFONTEIN LIBRARY

(C3) **Designated product(s)** STEEL PRODUCTS AND COMPONENTS FOR CONSTRUCTION

(C4) **Tender Authority:**

(C5) **Tendering Entity name:** VLEIFONTEIN LIBRARY

(C6) **Tender Exchange Rate:** Pula EU GBP

(C7) **Specified local content %**

Note: VAT to be excluded from all calculations

Calculation of local content

Tender item no's	List of items	Tender price - each (excl VAT)	Exempted imported value	Tender value net of exempted imported content	Imported value	Local value	Local content % (per item)
(C8)	(C9)	(C10)	(C11)	(C12)	(C13)	(C14)	(C15)
2-14-58-5	75 x 75mm diameter rainwater pipes fixed to column						
2-14-58-6	Extra over rainwater pipe for bend						
2-14-58-7	Extra over rainwater pipe for eaves or plinth offset						
2-14-58-8	Extra over rainwater pipes for shoe						

Tender Qty	Total tender value	Total exempted imported content	Total Imported content
(C16)	(C17)	(C18)	(C19)
36			
26			
13			
13			

Signature of tenderer from Annex B

Date: _____

(C20) Total tender value	R 0	
(C21) Total Exempt imported content	R 0	
(C22) Total Tender value net of exempt imported content	R 0	
(C23) Total Imported content	R 0	
(C24) Total local content	R 0	
(C25) Average local content % of tender		

Annex C

Local Content Declaration - Summary Schedule

(C1) Tender No. LDPWRI-B/20151
 (C2) Tender description: CONSTRUCTION OF THE NEW VLEIFONTEIN LIBRARY
 (C3) Designated product(s) PLASTIC PIPES
 (C4) Tender Authority:
 (C5) Tendering Entity name: VLEIFONTEIN LIBRARY
 (C6) Tender Exchange Rate: Pula EU GBP
 (C7) Specified local content %

Note: VAT to be excluded from all calculations

Calculation of local content											
Tender item no's	List of items	Tender price - each (excl VAT)	Exempted imported value	Tender value net of exempted imported content	Imported value	Local value	Local content % (per item)	Tender Qty	Total tender value	Total exempted imported content	Total Imported content
(C8)	(C9)	(C10)	(C11)	(C12)	(C13)	(C14)	(C15)	(C16)	(C17)	(C18)	(C19)
2-14-61-29	50mm Pipes fixed to walls, etc.							48			
2-14-61-30	110mm Pipes fixed to walls, etc.							16			
2-14-61-31	110mm Pipes laid in and including trenches not exceeding 1m deep							180			
2-14-61-32	50mm Bend							20			
2-14-61-33	50mm Access bend							5			
2-14-61-34	110mm Bend							24			
2-14-61-35	110mm Tee junction							10			
2-14-61-36	110 x 50 mm Reducing junction							5			
2-14-60-21	15mm Chromium plated full way ballcock shut-off control valve with screw type control							2			
2-14-60-22	15mm Brass stopcock							28			
2-14-60-23	15mm Chromium sink mixer (Code 266/04/10)							1			
2-14-60-24	Selene 953, pillartap							21			

(C20) Total tender value R 0

(C21) Total Exempt imported content R 0

(C22) Total Tender value net of exempt imported content R 0

(C23) Total Imported content R 0

(C24) Total local content R 0

(C25) Average local content % of tender

Signature of tenderer from Annex B

Date: _____

Annex C

Local Content Declaration - Summary Schedule

(C1) Tender No. LDPWRI-B/20151
 (C2) Tender description: CONSTRUCTION OF THE NEW VLEIFONTEIN LIBRARY
 (C3) Designated product(s) VALVES PRODUCTS AND ACUTORS
 (C4) Tender Authority:
 (C5) Tendering Entity name: VLEIFONTEIN LIBRARY
 (C6) Tender Exchange Rate: Pula EU GBP
 (C7) Specified local content %

Note: VAT to be excluded from all calculations

Calculation of local content											
Tender item no's	List of items	Tender price - each (excl VAT)	Exempted imported value	Tender value net of exempted imported content	Imported value	Local value	Local content % (per item)	Tender Qty	Total tender value	Total exempted imported content	Total Imported content
(C8)	(C9)	(C10)	(C11)	(C12)	(C13)	(C14)	(C15)	(C16)	(C17)	(C18)	(C19)
	Cem II (Cement)							148.05			
	Masonry cement							37.88			

(C20) Total tender value	R 0
(C21) Total Exempt imported content	R 0
(C22) Total Tender value net of exempt imported content	R 0
(C23) Total Imported content	R 0
(C24) Total local content	R 0
(C25) Average local content % of tender	

Signature of tenderer from Annex B _____

Date: _____

Annex D

Imported Content Declaration - Supporting Schedule to Annex C

<i>(D1)</i> Tender No.	LDPWRI-B/20151	Note: VAT to be excluded from all calculations
<i>(D2)</i> Tender description:	CONSTRUCTION OF THE NEW VLEIFONTEIN LIBRARY	
<i>(D3)</i> Designated Products:		
<i>(D4)</i> Tender Authority:		
<i>(D5)</i> Tendering Entity name:	VLEIFONTEIN LIBRARY	
<i>(D6)</i> Tender Exchange Rate:	Pula <input style="width: 50px;" type="text"/> EU <input style="width: 50px;" type="text"/> GBP <input style="width: 50px;" type="text"/>	

A. Exempted imported content

				Calculation of imported content						Summary	
Tender item no's	Description of imported content	Local supplier	Overseas Supplier	Foreign currency value as per Commercial Invoice	Tender Exchange Rate	Local value of imports	Freight costs to port of entry	All locally incurred landing costs & duties	Total landed cost excl VAT	Tender Qty	Exempted imported value
<i>(D7)</i>	<i>(D8)</i>	<i>(D9)</i>	<i>(D10)</i>	<i>(D11)</i>	<i>(D12)</i>	<i>(D13)</i>	<i>(D14)</i>	<i>(D15)</i>	<i>(D16)</i>	<i>(D17)</i>	<i>(D18)</i>
<i>(D19)</i> Total exempt imported value										R 0	

This total must correspond with Annex C - C 21

B. Imported directly by the Tenderer

				Calculation of imported content						Summary	
Tender item no's	Description of imported content	Unit of measure	Overseas Supplier	Foreign currency value as per Commercial Invoice	Tender Rate of Exchange	Local value of imports	Freight costs to port of entry	All locally incurred landing costs & duties	Total landed cost excl VAT	Tender Qty	Total imported value
<i>(D20)</i>	<i>(D21)</i>	<i>(D22)</i>	<i>(D23)</i>	<i>(D24)</i>	<i>(D25)</i>	<i>(D26)</i>	<i>(D27)</i>	<i>(D28)</i>	<i>(D29)</i>	<i>(D30)</i>	<i>(D31)</i>
<i>(D32)</i> Total imported value by tenderer										R 0	

Annex E

Local Content Declaration - Supporting Schedule to Annex C

(E1)	Tender No.	LDPWRI-B/20151	Note: VAT to be excluded from all calculations
(E2)	Tender description:	CONSTRUCTION OF THE NEW VLEIFONTEIN LIBRARY	
(E3)	Designated products:		
(E4)	Tender Authority:		
(E5)	Tendering Entity name:	VLEIFONTEIN LIBRARY	

Local Products (Goods, Services and Works)	Description of items purchased	Local suppliers	Value
	(E6)	(E7)	(E8)
(E9) Total local products (Goods, Services and Works)			R 0

(E10)	Manpower costs	(Tenderer's manpower cost)	R 0
(E11)	Factory overheads	(Rental, depreciation & amortisation, utility costs, consumables etc.)	R 0
(E12)	Administration overheads and mark-up	(Marketing, insurance, financing, interest etc.)	R 0
(E13) Total local content			R 0

This total must correspond with Annex C - C24

Signature of tenderer from Annex B

Date: _____

SBD 8: DECLARATION OF BIDDER'S PAST SUPPLY CHAIN MANAGEMENT PRACTICES

- 1 This Standard Bidding Document must form part of all bids invited.
- 2 It serves as a declaration to be used by institutions in ensuring that when goods and services are being procured, all reasonable steps are taken to combat the abuse of the supply chain management system.
- 3 The bid of any bidder may be disregarded if that bidder or any of its directors have-
 - a. abused the institution's supply chain management system;
 - b. committed fraud or any other improper conduct concerning such system; or
 - c. failed to perform on any previous contract.
- 4 **To give effect to the above, the following questionnaire must be completed and submitted with the bid.**

Item	Question	Yes	No
4.1	<p>Is the bidder or any of its directors listed on the National Treasury's Database of Restricted Suppliers as companies or persons prohibited from doing business with the public sector?</p> <p>(Companies or persons who are listed on this Database were informed in writing of this restriction by the Accounting Officer/Authority of the institution that imposed the restriction after the <i>audi alteram partem</i> rule was applied).</p> <p>The Database of Restricted Suppliers now resides on the National Treasury's website(www.treasury.gov.za) and can be accessed by clicking on its link at the bottom of the home page.</p>	Yes <input type="checkbox"/>	No <input type="checkbox"/>
4.1.1	If so, furnish particulars:		
4.2	<p>Is the bidder or any of its directors listed on the Register for Tender Defaulters in terms of section 29 of the Prevention and Combating of Corrupt Activities Act (No 12 of 2004)?</p> <p>The Register for Tender Defaulters can be accessed on the National Treasury's website (www.treasury.gov.za) by clicking on its link at the bottom of the home page.</p>	Yes <input type="checkbox"/>	No <input type="checkbox"/>
4.2.1	If so, furnish particulars:		
4.3	<p>Was the bidder or any of its directors convicted by a court of law (including a court outside of the Republic of South Africa) for fraud or corruption during the past five years?</p>	Yes <input type="checkbox"/>	No <input type="checkbox"/>
4.3.1	If so, furnish particulars:		
4.4	<p>Was any contract between the bidder and any organ of state terminated during the past five years on account of failure to perform on or comply with the contract?</p>	Yes <input type="checkbox"/>	No <input type="checkbox"/>
4.4.1	If so, furnish particulars:		

CERTIFICATION

I, THE UNDERSIGNED (FULL NAME)
CERTIFY THAT THE INFORMATION FURNISHED ON THIS DECLARATION FORM IS TRUE AND CORRECT.

I ACCEPT THAT, IN ADDITION TO CANCELLATION OF A CONTRACT, ACTION MAY BE TAKEN AGAINST
ME SHOULD THIS DECLARATION PROVE TO BE FALSE.

.....
Signature

.....
Date

.....
Position

.....
Name of Bidder

SBD 9: CERTIFICATE OF INDEPENDENT BID DETERMINATION

- 1 This Standard Bidding Document (SBD) must form part of all bids¹ invited.
- 2 Section 4 (1) (b) (iii) of the Competition Act No. 89 of 1998, as amended, prohibits an agreement between, or concerted practice by, firms, or a decision by an association of firms, if it is between parties in a horizontal relationship and if it involves collusive bidding (or bid rigging).² Collusive bidding is a *per se* prohibition meaning that it cannot be justified under any grounds.
- 3 Treasury Regulation 16A9 prescribes that accounting officers and accounting authorities must take all reasonable steps to prevent abuse of the supply chain management system and authorizes accounting officers and accounting authorities to:
 - a. disregard the bid of any bidder if that bidder or any of its directors have abused the institution's supply chain management system and or committed fraud or any other improper conduct concerning such system.
 - b. cancel a contract awarded to a supplier of goods and services if the supplier committed any corrupt or fraudulent act during the bidding process or the execution of that contract.
- 4 This SBD serves as a certificate of declaration that would be used by institutions to ensure that, when bids are considered, reasonable steps are taken to prevent any form of bid-rigging.
- 5 In order to give effect to the above, the attached Certificate of Bid Determination (SBD 9) must be completed and submitted with the bid:

CERTIFICATE OF INDEPENDENT BID DETERMINATION

I, the undersigned, in submitting the accompanying bid:

(Bid Number and Description)

in response to the invitation for the bid made by:

(Name of Institution)

do hereby make the following statements that I certify to be true and complete in every respect:

I certify, on behalf
of: _____ that:

(Name of Bidder)

1. I have read and I understand the contents of this Certificate;
2. I understand that the accompanying bid will be disqualified if this Certificate is found not to be true and complete in every respect;
3. I am authorized by the bidder to sign this Certificate, and to submit the accompanying bid, on behalf of the bidder;
4. Each person whose signature appears on the accompanying bid has been authorized by the bidder to determine the terms of, and to sign the bid, on behalf of the bidder;
5. For this Certificate and the accompanying bid, I understand that the word "competitor" shall include any individual or organization, other than the bidder, whether or not affiliated with the bidder, who:
 - (a) has been requested to submit a bid in response to this bid invitation;
 - (b) could potentially submit a bid in response to this bid invitation, based on their qualifications, abilities or experience; and
 - (c) provides the same goods and services as the bidder and/or is in the same line of business as the bidder
6. The bidder has arrived at the accompanying bid independently from, and without consultation, communication, agreement or arrangement with any competitor. However, communication between partners in a joint venture or consortium³ will not be construed as collusive bidding.
7. In particular, without limiting the generality of paragraphs 6 above, there has been no consultation, communication, agreement or arrangement with any competitor regarding:
 - (a) prices;
 - (b) the geographical area where product or service will be rendered (market allocation)
 - (c) methods, factors or formulas used to calculate prices;
 - (d) the intention or decision to submit or not to submit, a bid;
 - (e) the submission of a bid which does not meet the specifications and conditions of the bid; or
 - (f) bidding with the intention not to win the bid.

- 8. In addition, there have been no consultations, communications, agreements or arrangements with any competitor regarding the quality, quantity, specifications, and conditions or delivery particulars of the products or services to which this bid invitation relates.
- 9. The terms of the accompanying bid have not been, and will not be, disclosed by the bidder, directly or indirectly, to any competitor, before the date and time of the official bid opening or of the awarding of the contract.
- 10. I am aware that, in addition, and without prejudice to any other remedy provided to combat any restrictive practices related to bids and contracts, bids that are suspicious will be reported to the Competition Commission for investigation and possible imposition of administrative penalties in terms of section 59 of the Competition Act No 89 of 1998 and or may be reported to the National Prosecuting Authority (NPA) for criminal investigation and or may be restricted from conducting business with the public sector for a period not exceeding ten (10) years in terms of the Prevention and Combating of Corrupt Activities Act No 12 of 2004 or any other applicable legislation.

.....
Signature

.....
Date

.....
Position

.....
Name of Bidder

¹ Includes price quotations, advertised competitive bids, limited bids and proposals.

² Bid rigging (or collusive bidding) occurs when businesses, that would otherwise be expected to compete, secretly conspire to raise prices or lower the quality of goods and / or services for purchasers who wish to acquire goods and / or services through a bidding process. Bid rigging is, therefore, an agreement between competitors not to compete.

³ Joint venture or Consortium means an association of persons for the purpose of combining their expertise, property, capital, efforts, skill, and knowledge in an activity for the execution of a contract.

SAFCEC JOINT VENTURE AGREEMENT

JOINT VENTURE AGREEMENT made and entered into by and between:

.....of
..... (hereafter referred to as)

of the first part;

and

..... of
..... (hereafter referred to as)

of the second part;

PREAMBLE

WHEREAS the Parties have formed a Joint Venture in order to submit tenders to the

..... for the construction of
.....

(hereafter referred to as the "works").

NOW THEREFORE, IT IS AGREED AS FOLLOWS:

1. FORMATION OF JOINT VENTURE

- 1.1 The Parties hereby associate themselves into and as a Joint Venture in accordance with the provisions of this Agreement under the style or firm name of JOINT VENTURE.
- 1.2 The Parties hereto agree and undertake that they will not disclose the contents of this Agreement to persons with whom they may have any dealings directly or indirectly arising from the conclusion of this Agreement and the operation and establishment of the Works.
- 1.3 Notwithstanding that the parties may be jointly and severally bound to the, should the Joint Venture be awarded the contract by the for the construction of the Works, nothing herein contained shall be interpreted as giving rise to a general partnership between the parties or limiting the rights or powers of either party to carry on its separate business for its sole benefit.

2. OBJECT AND MOTIVATION

The sole object for which this Joint Venture is established and the sole business of the Joint Venture is to negotiate for and conclude a contract for the execution of the Works and to carry out such Works to finality, all in accordance with the terms of this Agreement.

3. PROFITS AND LOSSES

- 3.1 The profits and losses of the Joint Venture shall be borne by and In the proportions% and% respectively (hereinafter referred to as "the Specified Proportions").
- 3.2 In addition to any other provisions contained in this Agreement, the functions, duties, obligations and responsibilities of and under this Joint Venture agreement and in the execution of the Works will be to provide all bridging finance, guarantees and resources necessary to successfully carry out the project in proportion to the specified proportions, in which proportions all profits, losses, costs, liabilities and assets and any other responsibilities, whether pecuniary or otherwise, shall be shared equally, as far as possible.

4 DURATION

The operation of this Agreement shall be deemed to have commenced on the Day of 200..., and shall terminate, except insofar as the provisions of Clauses 5 and 6 apply, upon the happening of any of the following events, whichever shall be earlier:

- 4.1 Award of the Contract byfor the construction of the Works to an outside party or parties, or
- 4.2 In the case of contract award, at the time the contract is terminated and all rights and obligations of the parties in connection with such contract and in connection with this Agreement have ceased, but in no case before the conclusion of any maintenance period in the contract and the cancellation and/or refund of all guarantees and bonds. The Joint Venture existence shall also be deemed to continue insofar as the Joint Venture is responsible for latent defects under the contract.

5. EXCLUSIVITY

The Parties agree and undertake in favour of each other that neither of them shall, except in accordance with the intention expressed in this agreement, be associated in any manner, either directly or indirectly, with any investigation, negotiation, tender or proposal for the performance of or incidental to the execution of the Works and including any variation by way of addition or omission from the scope of the Works or the extension to the Works, nor invest in any company, enterprise or partnership in any manner related thereto, either as previously agreed by the Management Committee in writing.

6. PRE-CONTRACT COSTS

- 6.1 All costs incurred by the Parties prior to the day of.....20...., shall be for their own account.
- 6.2 Costs incurred by the Parties after the day of 200... and approved by the Management Committee, shall be borne by the Parties in the Specified Proportions.

7. MANAGEMENT COMMITTEE

- 7.1 The day-to-day affairs of the Joint Venture shall be under the control of a Management Committee which shall consist of one representative of each of the parties. Within the terms of this agreement and the contract, if awarded, each such member shall have full authority to bind the party and/or parties he represents in all matters relating to the affairs of the Joint Venture. No party to this agreement may bind the other party hereto without the prior consent of such other party, nor may the Management Committee bind the Joint Venture or any party beyond the terms of this agreement or the contract without the prior written consent of both parties. The parties hereto shall be obliged immediately upon signature of this Agreement, to appoint their representatives and the first meeting of the Management Committee will be held immediately thereafter. The parties shall be obliged at all times to maintain a representative on the Management Committee.
- 7.2 Each representative on the Management Committee shall be entitled to appoint, and from time to time remove and replace, an alternate who shall, at any meeting of the Management Committee at which the representative whom he represents is absent, be vested with all rights and powers and subject to all obligations of the representative whom he represents.
- 7.3 The Chairman at meetings of the Management Committee shall be a representative from and respectively on a six months rotation basis commencing with
- 7.4 Meetings of the Management Committee shall take place at such times and places as the Committee shall determine, provided that the Chairman shall be obliged to convene a meeting of the Management Committee not later than 10 days after being required to do so by any one of the parties to this agreement. Not less than five days' notice of any meeting of the Management Committee shall be given to the representatives thereof and their alternates.
- 7.5 Decisions of the Management Committee shall be unanimous, provided that If the representatives or the alternates fail to agree on any decision, the meeting at which that decision is sought shall be adjourned for a period of 24 hours and should the representatives then not agree on the course of action to be taken the matter shall be referred to the Executive Board for a decision. The decision of such Executive Board shall be placed before a further adjourned meeting, which shall take place no later than 72 hours after the initial adjourned meeting and shall bin the Management Committee which shall adopt such decision without variation.
- 7.6 Subject to 7.7 below, decisions on the Management Committee may be reached telephonically, telegraphically, by facsimile or in writing.
- 7.7 Decisions of the Management Committee, whether at a meeting or otherwise, shall be recorded in written minutes which shall be distributed by the Chairman, for the time being to the members of the Management Committee not later than seven days after those decisions have been taken.

Such minutes shall be deemed to have been affirmed unless dissented from not later than seven days after they are deemed to have been received by the dissenter.

- 7.8 The Management Committee may, as it wishes, decide to increase the number of its members for or invite other parties to attend any of its meetings. Such co-opted members or observers shall not have a vote.
- 7.9 The Management Committee shall have the power to delegate such of its powers and duties as it may determine in the best interests of the parties.
- 7.10 No remuneration shall be paid by the Joint Venture to the parties' representatives on the Management Committee in their capacities as such.
- 7.11 The administrative function regarding the operation of the Management Committee shall be fulfilled by the Chairman.

8 POWERS OF THE MANAGEMENT COMMITTEE AND DIRECTION OF THE PROJECT MANAGER

The functions, responsibilities and powers of the Management Committee shall be:

- 8.1 To appoint the Project Manager who shall be nominated by and and who shall attend all meetings of the Management Committee for the implementation of its policies and act only in accordance with its directives and its established procedures. The Project Manager shall be removed in terms of 10 hereof and his successor(s) shall be nominated by and And approved by the Management Committee.
- 8.2 To formulate and dictate to the Project Manager overall policy regarding the following:
 - 8.2.1 The general day-to-day management of the affairs of the Joint Venture.
 - 8.2.2 Representation of the Joint Venture in dealing with the Resident Engineer/ Engineer/ Client and third parties on matters affecting the Joint Venture as a whole.
 - 8.2.3 Co-ordination of the activities of the parties.
 - 8.2.4 Preparation by agreement with the parties and supervision of the programme of the Works.
 - 8.2.5 Ensuring that the responsibility of each of the parties in regard to technical and contractual matters is preserved.
- 8.3 To make such provisions as are necessary to enable the Project Manager to perform his tasks.
- 8.4 To approve the balance sheets and accounts of the Joint Venture.
- 8.5 To approve the tender submitted by the Joint Venture and to approve or withhold approval for and amendment proposed thereto.
- 8.6 To approve the appointment of legal advisers and auditors where such appointments are necessary.
- 8.7 To determine the nature and extend of any additional duties and functions of each of the parties in relation to this Joint Venture.
- 8.8 To determine the terms and conditions of employment of personnel as well as emoluments seconded by the parties to the Joint Venture.
- 8.9 Subject to the terms and conditions of this agreement, to determine and approve:
 - 8.9.1 The amount and type of working capital requirements of the Joint Venture.
 - 8.9.2 All borrowings, guarantees and like obligations undertaken by the parties to the Joint Venture.
 - 8.9.3 The insurance to be taken out by the Joint Venture.

8.9.4 The nature, method and amount of all claims.

8.9.5 When and in what amount to distribute dividends to the parties hereto, save that any decision in terms of which the Joint Venture will undertake further work outside of the original scope of the contract or any variation or amendment of this agreement of the contract, shall require the unanimous agreement of the parties before becoming effective and binding the Joint Venture.

8.9.6 The approval and appointment of all sub-contractors.

9 THE EXECUTIVE BOARD

- 9.1 The Executive Board shall consist of one representative of each of the parties who shall be the Chief Executive Officer of each Joint Venture partner or their nominated deputy but shall not be the same representative as appointed to the Management Committee in terms of Clause 7.1 hereof. The Executive Board shall be the mediation authority of the Joint Venture which shall decide on all issues which are referred to it by the Management Committee as well as on all issues where the Management Committee is not unanimous.
- 9.2 Decisions of the Executive Board, whether original decisions or decisions taken after referral from the Management Committee shall be implemented by the Management Committee as per Clause 7.5.1.
- 9.3 Decisions of the Executive Board shall be unanimous.
- 9.4 Effect shall be given to a resolution arrived at unanimously.
- 9.5 In the event of the Executive Board not being unanimous in its decision the matter is to be referred to arbitration in terms of Clause 16 hereof.
- 9.6 Subject to 9.7 as read in conjunction with 7.7 and, provided that they are unanimous, decisions of the Executive Board may be reached telephonically, telegraphically or in writing. If reached telephonically or otherwise orally such decision must be confirmed in writing within 24 hours.
- 9.7 The Minutes of meetings of the Executive Board shall be handled mutatis mutandis in the manner per Clause 7.7.
- 9.8 The administrative functions regarding the operation of the Executive Board shall be fulfilled by the Chairman of the Management Committee, who shall not be entitled to a voice or a vote at Executive Board meetings.

10 PERSONNEL

- 10.1 The Project Manager shall be appointed as provided in Clause 8.1 hereof.
- 10.2 The person nominated to the office of Project Manager shall be subject to removal from such office by decision of the Management Committee.
- 10.3 All the remuneration and emoluments of employment of the Project Manager shall be an expense of and paid by the Joint Venture, provided that a party shall be entitled by notice in writing delivered to the other parties to elect that the person to be nominated by it to fill the offices of project Manager shall be seconded to the Joint Venture in which event the remuneration and emoluments which would otherwise have been paid to such persons while filling such offices shall be paid to the member responsible for their nomination or otherwise as such member shall direct and subject to such payment being duly and promptly paid to the member or its nominee, the member will hold harmless and keep indemnified the Joint Venture and the other members from all actions, proceedings, claims and demands by such persons or otherwise howsoever in respect of such remuneration and emoluments. The remuneration and emoluments to be paid and allowed by the Joint Venture to the Project Manager shall be

determined from time to time by the Management Committee and borne by the parties hereto in the Specified Propositions.

- 10.4 The members of the Management Committee and Executive Board and their proxies and alternates shall not be employees of the Joint Venture and shall not be entitled to claim any salary or remuneration from the Joint Venture by virtue of such appointments unless the Management Committee shall otherwise decide in writing.
- 10.5 shall be appointed as Secretaries to the Joint Venture. Save for matters pertaining to the works and the contract, Shall be consulted on all matters of an administrative and financial nature arising in connection with the business of the Joint Venture where their particular experience, knowledge, facilities and skills in matters of this nature shall be considered to be of benefit to the Joint Venture.

11 FINANCING

11.1 Working Capital

- 11.1.1 Banking accounts shall be opened in the name of the Joint Venture with banks and at such places as may be determined by it, and the parties shall be responsible for the payment in the Specified Properties of such sums to the credit of such banking accounts as shall from time to time be required by way of working capital for the Joint Venture.
- 11.1.2 Any amounts from time to time advanced by the parties to the Joint Venture in terms of this agreement shall be placed to the credit of their respective capital accounts in the Joint Venture.
- 11.1.3 The banking accounts referred to in sub-clause 11.1.1 hereof shall be operated, and cheques thereon shall be drawn in accordance with the instructions to the bankers in question. Withdrawals from these banking accounts shall be effected on the authority of persons nominated thereto by the Management Committee.
- 11.1.4 Should any party fail to make payment to the Joint Venture of any amount which it is obliged to pay in terms of sub-clause 11.1.1 hereof, after the expiry of a period of seven days from the date of notice requiring it to make such payment, the party to default shall be liable for payment of interest to the other parties on the amount so withheld at the rate of Prime Bank rate charged by Joint Venture Bankers per annum should such other parties have advanced the aforesaid sum.
- 11.1.5 All revenue derived by the Joint Venture from the contract shall forthwith be deposited to the credit of the banking accounts referred to in sub-Clause 1.1.1 hereof.
- 11.1.6 The amount for the time being standing to the credit of the Joint Venture's banking accounts shall be applied:

- 11.1.6.1 In discharging the obligations of the Joint Venture in accordance with their tenor; provided that the Management Committee shall be entitled to require the payment of any liability prior to its due date if such anticipated payment will result in the allowance by the creditor in question of an advantageous discount to the Joint Venture for prompt payment;
- 11.1.6.2 As to any surplus of funds for the time being in the said banking account, subject to the agreement of the parties as payment to the parties in the Specified Proportions or in proportion to their participation of the time being in the Joint Venture, save that any such surplus shall first be utilised for the purpose of eliminating or reducing any disproportion in the ratios of the parties respective capital accounts.

11.2 Capital and Advances

- 11.2.1 The amount of capital required by the Joint Venture to attain its object (and which includes all loans, guarantees, indemnities, reserves) shall be determined from time to time by the Management Committee, and upon being so determined shall forthwith be contributed by the parties to the Joint Venture in the Specified Proportions.
- 11.2.2 If at any time any party to the Joint Venture shall, due to an emergency or with the consent in writing of the other parties advance any sum of money or to incur any liability on behalf of the Joint Venture over and above its due contribution to capital, then where money has been advanced, the same shall be a debt due from the Joint Venture to the party advancing the money, and shall be repayable on thirty days' notice and shall bear interest at Prime Bank rate as charged by Joint Venture's bankers per annum from date of advance to date of payment. Where a party has incurred a contingent liability on the above basis, the other parties shall, within thirty days of being requested to do so in writing, relieve such party of its obligations thereunder to the extent that the obligations of the parties are in the Specified Proportions.

12. ACCOUNTS

- 12.1 The Joint Venture shall cause proper books of account and complete records to be kept as are customary in the Republic of South Africa relating to all the assets and liabilities of the Joint Venture and expenses incurred or income received by the Joint Venture.

Such book and records shall not be related to the affairs of the parties individually. The said books of account and records, together with all letters, papers or writings concerning or belonging to the Joint Venture shall be kept at site and such other place from time to time as determined by the Management Committee, and each of the parties to the Joint Venture shall at all times have free access and the right to inspect and copy the same.

- 12.2 Within thirty days of the end of every quarter during the continuance of the Joint Venture, the Joint Venture shall furnish to the Management Committee all necessary documents such as balance sheets, profit and loss accounts, bank balances and comparisons with budget and forecasts of cash flow and profits as are necessary to keep the Management Committee informed of the financial affairs of the Joint Venture. Every such profit and loss account and balance sheet shall be agreed to and signed by the members of the Management Committee on behalf of the Joint Venture members, and when so signed, shall be binding on all the parties, except that if any manifest error therein be detected and pointed out by any party to the others at any time after such signature, such error shall forthwith be rectified.

- 12.3 After the completion of the contract and the release of all bonds, guarantees and obligations given for the performance of the parties in the Joint Venture, the joint Venture shall procure the preparation and auditing of a final balance sheet and profit and loss account, which shall be approved by the Management Committee, and from which the final profit and loss sustained by the Joint Venture shall be ascertained, and distributed to or contributed by the parties in proportion to their participation in the Joint Venture. This clause shall not be construed as prohibiting the interim distribution of profits or contribution towards losses in the discretion of the Management Committee.

13. WINDING UP

Upon the determination of the Joint Venture in accordance with the provisions of this agreement, a full and general account shall be taken of the assets and liabilities of the Joint Venture and of the transactions and dealings thereof, and with all convenient speed, such assets shall be sold and realised and the proceeds applied in paying and discharging such liabilities and the expenses of and incidental to the winding-up of the Joint Venture affairs and thereafter in paying to each Joint Venture member its share of such proceeds in the Specified Proportions. The Joint Venture members respectively undertake to do all such things as may be necessary so as to give effect to the above.

14. BREACH

- 14.1 If a party ("the guilty party") shall commit a breach of any material provision of this agreement, and fail to remedy the same within a period of thirty (30) days after the receipt by it of written notice requiring it to do so, or be placed in liquidation or under judicial management, whether provisionally or finally, or propose any compromise with its creditors, the other parties ("the aggrieved parties") shall have the right, without prejudice to any of its other remedies arising from such breach, forthwith to terminate this agreement, in which event:
- 14.2 The guilty party's interest in the joint venture shall be taken over by the remaining parties. The aggrieved parties shall, in addition, have the right, if it so requires, to take over the capital account of the party in default.
Such capital account shall be valued on the basis of the nett assets revealed in an audited balance sheet and profit and loss account prepared as at the end of the month in which the default or other breach occurred; provided that the profit and loss account shall take into account the Joint Venture's share in the valuation of the work in progress, as shown in the Joint Venture accounts, at the date of preparation of the balance sheet and profit and loss account, after providing for any known or contemplated future losses to be incurred on the work undertaken or to be undertaken by the Joint Venture and provided further that should upon the completion of the contract or contracts, the provision for losses made in the valuation or work in progress as aforesaid prove to be incorrect, such provisions shall be adjusted. Provided the aggrieved parties have proved that the tender rates as escalated from time to time were inadequate, the guilty party shall be liable to the extent of the participation of such party for all losses incurred on the whole of the contract, including any losses incurred subsequent to the termination of the agreement in accordance with these provisions, but such party shall not be entitled to share in any profits earned subsequent to such termination.
- 14.3 The aggrieved parties shall have the right to recruit in its employment personnel seconded to the Joint Venture by the guilty party and, as a stipulation in favour of such personnel, the guilty party waives any claims it might otherwise have had against such personnel arising from their summary termination of their employment with the guilty party.

14.3 All plant hired by the guilty party to the Joint Venture shall remain on hire to and under the control of the aggrieved parties until the completion of the contract, or until the aggrieved parties shall release such plant from the operation of this sub-clause. Payment shall be made thereof monthly.

15. DISPUTES

15.1 Having regard to the high degree of good faith which must exist between the parties, the parties agree to do their utmost to ensure that the disputes between them are settled equitably and amicably and where possible without resort to arbitration.

15.2 In the event of any differences or dispute of whatever nature arising from this agreement (which shall include any failure to agree on any matter which requires the parties' agreement for the purposes of implementation of this agreement) or any other matter related thereto which cannot be settled by direct negotiation between the parties, such differences or dispute shall be referred to arbitration in terms of Clause 16 hereof.

16 ARBITRATION

16.1 Save as hereinafter provided, any dispute at any time between any of the parties hereto in regard to any matter arising out of this agreement or its interpretation or rectification shall be submitted to and decided by arbitration.

16.2 The arbitration referred to in 16.1 shall be held -

16.2.1 At

16.2.2 In a summary manner, i.e. on the basis that it shall not be necessary to observe or carry out either -

16.2.2.1 the usual formalities or procedure (e.g. there shall not be any pleadings or discovery); or

16.2.2.2 the strict rules of evidence.

16.2.3 Immediately and with a view to its being completed within twenty-one business days after it is demanded;

16.2.4 Otherwise (but subject to © (d) and (e) under the provisions of the Arbitration Act No. 42 of 1965 or the Republic of South Africa as amended from time to time).

16.3 The Arbitrator shall be, if the question in issue is -

16.3.1 Primarily an accounting matter, an independent accountant;

16.3.2 Primarily a legal matter, a practising Senior Counsel of not than five years standing as such;

16.3.3 Any other matter, an independent person unanimously agreed upon between the parties and failing agreement appointed by the President for the time being of the South African Federation of Civil Engineering Contractors.

- 16.4 If agreement cannot be reached within seven business days after the arbitration has been demanded as to whether the question in issue falls under 16.3.1, 16.3.2 or 16.3.3, then a practising Senior Counsel of not less than five years' standing as such agreed upon between the parties, and failing agreement appointed by the President for the time being of the Society of Chartered Accountants as soon as possible, thereafter, shall determine whether the question in issue falls under 16.3.1, 16.3.2 or 16.3.3 so that an arbitrator can be appointed, and the arbitration can be held and concluded, if possible, within the prescribed period of twenty-one days.
- 16.5 The arbitrator shall decide the matters submitted to him according to what he considers just and equitable in the circumstances and, therefore, the strict rules of law need not be observed or be taken into account by him in arriving at his decision.
- 16.6 The parties irrevocably agree that the decision in those arbitration proceedings -
 - 16.6.1 shall be binding on them;
 - 16.6.2 shall be carried into effect;
 - 16.6.3 can be made an order of any court of competent jurisdiction.

17. CONFIDENTIALITY

- 17.1 All matters relating to this agreement, any negotiations and the contract for the construction of the Works resulting therefrom shall be regarded by the parties hereto as being highly confidential, and shall not be disclosed without prior written consent of the management Committee to any party, person or entity who or which is not a signatory to this Agreement, except where such disclosure is necessary for the fulfilment of this Agreement. No party shall at any time hereinafter use any technical information, save that in the public domain, acquired from the other parties hereto except for the purposes of fulfilment of the contract.
- 17.2 No party shall have the right to advertise, or otherwise permit, the dissemination of publicity concerning its participation in the Joint Venture unless:
 - 17.2.1 the relevant material shall make due reference to and acknowledgement of the work of the other parties;
 - 17.2.2 the relevant material shall, for its dissemination is within the control of the party in question, have been approved by the other parties, which approval shall not be unreasonably withheld.

18. ASSIGNMENT

- 18.1 No party shall cede, assign or in any other way make over any of its rights or obligations under this agreement without the written consent of the other parties except insofar as such assignment or alienation is to any wholly-owned subsidiary company of that party.
- 18.2 In the event of such assignment or alienation taking place, the initial party shall jointly and severally and in solidum guarantee the obligations or the assignee towards the remaining parties.

19 GENERAL

- 19.1 No party shall have a claim against the other parties arising out of a failure to secure the contract, except insofar as the parties are liable to bear the joint venture expenses in the Specified Proportions.
- 19.2 Any changes and supplementary provisions concerning this agreement shall require the written approval of all the parties hereto.

19.3 Variations not effective unless in writing

No variation, modification or waiver of any provision of this agreement, or consent to any departure therefrom, shall in any event be of any force or effect unless unanimous and confirmed in writing and signed by the parties; then such variation, modification, waiver or consent shall be effective only in the specific instance and for the purpose and to the extent for which made or given.

19.4 Additions to the Joint Venture

No additional parties shall be admitted to the Joint Venture unless the parties to this agreement unanimously agree and subject to the Conditions of Contract for the Works. All sub-contractors must be approved by the Management Committee in accordance with procedures to be established by the said Committee.

19.5 Company formation

Should the parties at any time unanimously agree to form a company to take over the interest of the Joint Venture in the contract and the assets of the joint Venture, the parties undertake to enter into a Shareholders Agreement embodying insofar as it is reasonably possible and practicable the terms hereof and, in addition, including therein a provision affording each party a right of pre-emption to any shares in the company which the other may from time to time wish to dispose of. For the Works the formation of a company shall be subject to the General Conditions of Contract for the Works.

19.6 Domicilium

19.6.1 The parties hereto respectively choose domicilium citandi et executandi for all purposes of and in connection with this agreement as follows:

.....

19.6.2 The parties hereto shall be entitled to change their domicilium from time to time, and any such change shall only be effective upon receipt of notice in writing by the other parties of such change.

19.6.3 All payments to be made pursuant to this agreement, and all notices, demands or communications intended for any party, shall be made or given at such party's domicilium for the time being, and if forwarded by prepaid registered post, shall be deemed to have been made or given seven days after the date of posting unless proved to the contrary.

19.7 Currency

All amounts referred to in this agreement and all monies payable to or by the parties to the Joint Venture in connection with the Joint Venture shall be both calculated and paid in currencies from time to time and at places to be agreed by the Management Committee.

19.8 Governing Law

This agreement shall be construed in accordance with and governed by the laws of Republic of South Africa. The English language version of this agreement shall prevail.

19.9 All correspondence between the parties in regard to this agreement and the contract shall be in the English language.

19.10 Each party shall bear its own costs incurred in the preparation and negotiation of this agreement.

19.11 This agreement over-rides any previous agreement or arrangements concluded between the parties in regard to the works and contract. Notwithstanding the provisions of Clause 19 hereof, the parties agree that any variations to the provision of this agreement and any decisions in terms of which this Joint Venture will undertake further work outside the original scope of the contract referred to earlier, shall require the unanimous agreement of the parties before becoming effective and binding on the parties.

19.12 In the interpretation of this agreement, works in the singular shall include the plural and vice versa as the context may require. The headings to clauses shall not be considered part thereof nor shall the words which they contain be taken into account in the interpretation of any clause.

THUS DONE AND SIGNED AT THISDAY OF
..... 20....

For and behalf of:

.....

AS WITNESS:

- 1.
- 2.

THUS DONE AND SIGNED AT THISDAY OF
..... 20...

For and behalf of:

.....

AS WITNESS:

- 1.
- 2.



THE CONTRACT

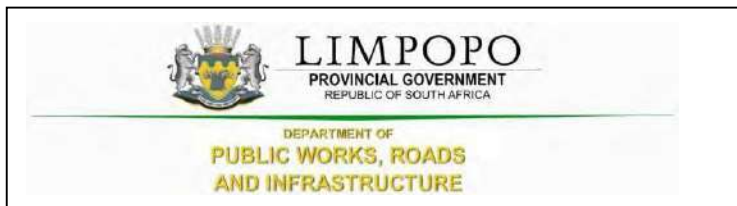

PART C1: AGREEMENT AND CONTRACT DATA

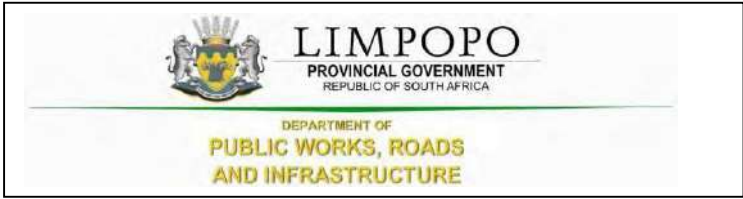

C1.1. FORM OF OFFER AND ACCEPTANCE

Offer

The employer, identified in the acceptance signature block, has solicited offers to enter into a contract in respect of the following works:

CONSTRUCTION OF NEW VLEIFONTEIN LIBRARY IN THE WATERBERG DISTRICT.

The tenderer, identified in the offer signature block, has examined the documents listed in the tender data and addenda thereto as listed in the tender schedules, and by submitting this offer has accepted the conditions of the tender.

By the representative of the tenderer, deemed to be duly authorized, signing this part of the Form of Offer and Acceptance, the tenderer offers to perform all of the obligations and liabilities of the contractor under the contract including compliance with all its terms and conditions according to their true intent and meaning for an amount to be determined in accordance with the conditions of contract identified in the contract data.

THE OFFERED TOTAL OF THE PRICE INCLUSIVE OF VALUE ADDED TAX IS (CONTRACT PRICE)

Rand (in words); R (in figures) R.....

This offer may be accepted by the employer by signing the acceptance part of this form of offer and acceptance and returning one copy of this document to the tenderer before the end of the period of validity stated in the tender data, whereupon the tenderer becomes the party named as the contractor in the conditions of contract identified in the contract data.

Signature(s)

Name(s)

Capacity

For the tenderer:

Name & signature of witness

Date

Acceptance (To be completed by the employer – not the bidder)

By signing this part of this Form of Offer and Acceptance, the *Employer* identified below accepts the tenderer's Offer. In consideration thereof, the *Employer* shall pay the Consultant the amount due in accordance with the *conditions of contract* identified in the Contract Data. Acceptance of the tenderer's Offer shall form an agreement between the *Employer* and the tenderer upon the terms and conditions contained in this agreement and in the contract that is the subject of this agreement.

The terms of the contract, are contained in:

- Part C1 Agreements and Contract Data, (which includes this Form of Offer and Acceptance)
- Part C2 Contract Data
- Part C3 Pricing Data
- Part C4 Scope of Work

Any drawings and documents (or parts thereof), which may be incorporated by reference into the above-listed Parts.

Deviations from and amendments to the documents listed in the Tender Data and any addenda thereto listed in the Returnable Schedules as well as any changes to the terms of the Offer agreed by the tenderer and the *Employer* during this process of offer and acceptance, are contained in the Schedule of Deviations attached to and forming part of this Form of Offer and Acceptance. No amendments to or deviations from said documents are valid unless contained in this Schedule.

The tenderer shall within two weeks of receiving a completed copy of this agreement, including the Schedule of Deviations (if any), contact the *Employer's* agent (whose details are given in the Contract Data) to arrange the delivery of any securities, bonds, guarantees, proof of insurance and any other documentation to be provided in terms of the *conditions of contract* identified in the Contract Data. Failure to fulfil any of these obligations in accordance with those terms shall constitute a repudiation of this agreement.

Notwithstanding anything contained herein, this agreement comes into effect on the date when the tenderer receives one fully completed original copy of this document, including the Schedule of Deviations (if any). Unless the tenderer (now *Consultant*) within five working days of the date of such receipt notifies the *Employer* in writing of any reason why he cannot accept the contents of this agreement, this agreement shall constitute a binding contract between the Parties.

For the Employer

Signature

Name

Capacity

Name and address of the organization

Signature and Name of Witness

Signature

Name

Capacity

Schedule of Deviations

- 1 Subject
- Details
-
-
-
-

- 2 Subject
- Details
-
-
-

- 3 Subject
- Details
-
-
-

- 4 Subject
- Details
-
-
-

By the duly authorized representatives signing this agreement, the *Employer* and the Tenderer agree to and accept the foregoing schedule of deviations as the only deviations from and amendments to the documents listed in the Tender Data and addenda thereto as listed in the returnable schedules, as well as any confirmation, clarification or changes to the terms of the offer agreed by the Tenderer and the *Employer* during this process of offer and acceptance.

It is expressly agreed that no other matter whether in writing, oral communication or implied during the period between the issue of the tender documents and the receipt by the tenderer of a completed signed copy of this Agreement shall have any meaning or effect in the contract between the parties arising from this agreement.

.....

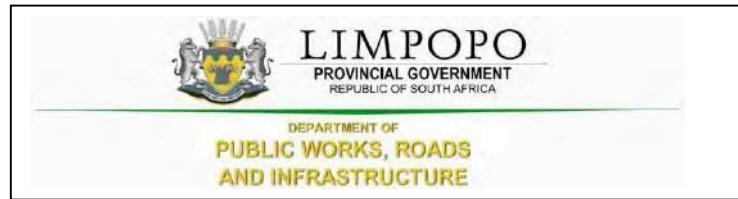

C2 CONTRACT DATA

The Conditions of Contract are clauses 1 to 41 of the **JBCC Series 2000 Principal Building Agreement (Edition 4.1 of March 2005)** published by the Joint Building Contracts Committee.

Copies of these conditions of contract may be obtained from the Association of South African Quantity Surveyors (011-3154140), Master Builders Association (011-205-9000; 057-3526269) South African Association of Consulting Engineers (011-4632022) or South African Institute of Architects (051-4474909; 011-4860684; 053-8312003;)

The JBCC Principal Building Agreement makes several references to the Contract Data for specific data, which together with these conditions collectively describe the risks, liabilities, and obligations of the contracting parties and the procedures for the administration of the Contract. The Contract Data shall have precedence in the interpretation of any ambiguity or inconsistency between it and the JBCC Principal Building Agreement.

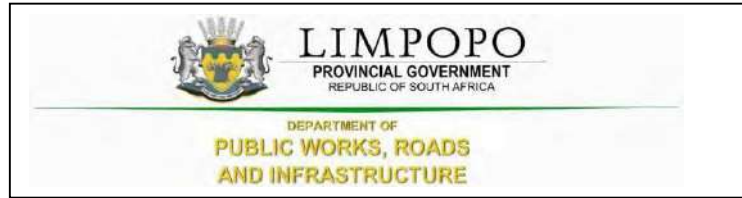

PART C3: PRICING DATA

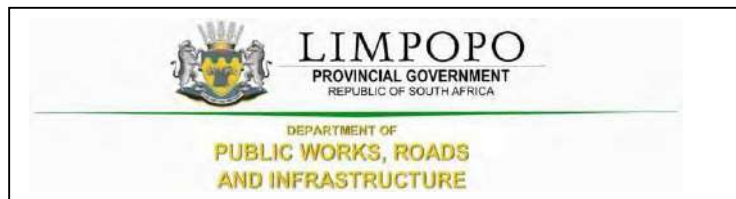

C3.1 PRICING INSTRUCTION

- The Bills of Quantities have been drawn up in accordance with the Standard System of Measuring Building Work in accordance with the provisions of the Model Bills of Quantities or Electrical Work, published by the South African Association of Quantity Surveyors, (July 2005).
- The agreement is under the JBCC N/S Subcontractor Agreement for use with the JBCC PBA (Edition 4.1 code 2101 March 2005) form of contract with Preliminaries (Code 2103 May 2005) incorporating the State Provisions of cl 41.0.
- It will be assumed that prices included in the Bills of Quantities are based on Acts, Ordinances, Regulations, By-laws, International Standards and National Standards that were published 28 days before the closing date for tenders.
- The prices and rates in these Bills of Quantities are fully inclusive prices for the work described under the items. Such prices and rates cover all costs and expenses that may be required in and for the execution of the work described in accordance with the provisions of the Scope of Works and shall cover the cost of all general risks, liabilities, and obligations set forth or implied in the Contract Data, as well as overhead charges and profit. These prices will be used as a basis for the assessment of payment for additional work that may have to be carried out.
- The drawings listed in the Scope of Works used for the setting up of these Bills of Quantities are kept by the Main Contractor and can be viewed at any time during office hours up until the completion of the works.
- An item against which no price is entered will be considered to be covered by the other prices or rates in the Bills of Quantities. A single lump sum will apply should a number of items be grouped together for pricing purposes.
- The Contract Data and the standard form of contract referenced therein must be studied for the full extent and meaning of each and every clause set out in Section 1 (Preliminaries) of the Bills of Quantities.
- The Bills of Quantities is not intended for the ordering of materials. Any ordering of materials, based on the Bills of Quantities, is at the Contractor's risk.

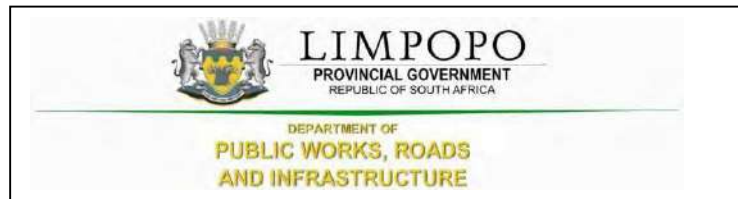

PART C4: PROVISIONAL BILLS OF QUANTITIES

**CONSTRUCTION OF NEW LIBRARY
INCLUDING ELECTRICAL, MECHANICAL INSTALLATION
AND ASSOCIATED EXTERNAL WORKS
AT VLEIFONTEIN, VHEMBE DISTRICT**

Item No	Quantity	Rate	Amount
<u>SECTION NO 1</u>			
<u>BILL NO. 1</u>			
<u>PRELIMINARIES</u>			
<u>PRELIMINARIES</u>			
All prices/rates to be net, excluding Value Added Tax			
<u>General</u>			
i) The agreement is to be the JBCC Series 2000 Principal Building Agreement (Edition 4.1) prepared by the Joint Building Contracts Committee, March 2005			
ii) The preliminaries are to be the JBCC Series 2000 Preliminaries prepared by the Joint Building Contracts Committee, March 2005 edition and shall be deemed to be incorporated herein			
iv) Where standard clauses or alternatives are not entirely applicable to this contract such modifications, corrections or supplements as will apply are given under each relevant clause heading			
iii) Tenderers are referred to the abovementioned documents for the full intent and meaning of each clause thereof (hereinafter referred to by heading and clause number only) for which such allowance must be made as may be considered necessary			
v) Where any item is not relevant to this specific contract such item is marked N/A (signifying "not applicable")			
Carried to Collection			R
Section No. 1 Bill No 1 - Preliminaries LDPW-B/20151 - BILLS OF QUANTITIES			

**CONSTRUCTION OF NEW LIBRARY
INCLUDING ELECTRICAL, MECHANICAL INSTALLATION
AND ASSOCIATED EXTERNAL WORKS
AT VLEIFONTEIN, VHEMBE DISTRICT**

- vi) If Alternative A as set out in clause B10.3 hereinafter is to be used for the adjustment of the preliminaries each item priced is to be allocated to one or more of the three categories, where "F" denotes a fixed amount (amount not to be varied), "V" denotes an amount variable in proportion to value and "T" denotes an amount in proportion to time
- vii) Any reference to the words "Tender" or "Tenderer" herein and/or in any other documentation shall be construed to have the same meaning as the words "Bid" or "Bidder"

SECTION A: JBCC PRINCIPAL BUILDING AGREEMENT

Definitions (A1)

1 Definitions and interpretation (clause 1)

Clause 1.1 Definition of "**Agreement**" is amended by replacing it with the following:

Agreement means the agreement arising from the signing of the Form of Offer and Acceptance by the parties.

Clause 1.1 Definition of "**Bills of Quantities**" is amended by adding the following:

"...and the Pricing Instructions contained in the Pricing Data" after the word measuring system.

Clause 1.1 Definition of "**Contract Documents**" is amended by adding the following:

". this Agreement and all other documents referenced therein.." after the word this document"

Clause 1.1 Definition of "**Contract Drawings**" is amended by replacing it with the following:

Contract Drawings means the drawings upon which the tender was accepted and used in preparing the bills

Carried to Collection

Section No. 1
Bill No 1 - Preliminaries
LDPW-B/20151 - BILLS OF QUANTITIES

R

**CONSTRUCTION OF NEW LIBRARY
INCLUDING ELECTRICAL, MECHANICAL INSTALLATION
AND ASSOCIATED EXTERNAL WORKS
AT VLEIFONTEIN, VHEMBE DISTRICT**

of quantities and are available for viewing at the offices of the Principal Agent at the time of tender

Clause 1.1 Definition of "**Contract Sum**" is amended by replacing it with the following:

Contract Sum means the total of prices in the Form of Offer and Acceptance.

Clause 1.1 Definition of "**Schedule**" is amended by adding the following:

".....and in the **Contract Data**". at the end on the sentence ending with **agreement**

Clause 1.1 Definition of "**Commencement Date**" is added:

"Commencement date" means the date that the **agreement**, made in terms of the Form of Offer and Acceptance, comes into effect

Clause 1.1 Definition of "**Construction Guarantee**" is amended by replacing it with the following:

"Construction guarantee" means guarantee at call obtained by the **contractor** from an institution approved by the **employer** in terms of the **employer's** construction guarantee form as selected in the **schedule**

Clause 1.1 Definition of "**Construction Period**" is amended by replacing it with the following:

"Construction period" means the period commencing on the commencement date and ending on the date of practical completion

Clause 1.1 Definition of "**Corrupt Practice**" is added:

"Corrupt Practice" means the offering , giving, receiving or soliciting of anything of value to influence the action of a public official in the procurement process or in contract execution

Clause 1.1 Definition of "**Fraudulent Practice**" is added:

Carried to Collection

Section No. 1
Bill No 1 - Preliminaries
LDPW-B/20151 - BILLS OF QUANTITIES

R

**CONSTRUCTION OF NEW LIBRARY
INCLUDING ELECTRICAL, MECHANICAL INSTALLATION
AND ASSOCIATED EXTERNAL WORKS
AT VLEIFONTEIN, VHEMBE DISTRICT**

"Fraudulent Practice" means a misrepresentation of facts in order to influence a procurement process or the execution of a contract to the detriment of any tenderer and includes collusive practice among tenderers (prior to or after the tender submission) designed to establish tender prices at artificial non-competitive levels and to deprive the tenderer of the benefits of free and open competition.

Clause 1.1 Definition of **"Interest"** is amended by replacing it with the following:

"Interest" means the interest rates applicable on this contract, whether specifically indicated in the relevant clauses or not, will be the rate as determined by the Minister of Finance, from time to time, in terms of section 80(1)(b) of the Public Finance Management Act, 1999 (Act No. 1 of 1999).

Clause 1.1 Definition of **"Principal Agent"** is amended by replacing it with the following:

"Principal Agent" means the person or entity appointed by the **employer** and named in the **schedule**. In the event of a **principal agent** not being appointed, then all the duties and obligations of a **principal agent** as detailed in the **agreement** shall be fulfilled by a representative of the **employer** as named in the **schedule**.

Clause 1.1 Definition of **"Security"** is amended by replacing it with the following:

Security means the form of security provided by the **employer** or **contractor**, as stated in the **schedule**, from which the **contractor** or **employer** may recover expense or loss

Fixed

Item

Value Related

Item

Time Related

Item

Carried to Collection

R

Section No. 1
Bill No 1 - Preliminaries
LDPW-B/20151 - BILLS OF QUANTITIES

**CONSTRUCTION OF NEW LIBRARY
INCLUDING ELECTRICAL, MECHANICAL INSTALLATION
AND ASSOCIATED EXTERNAL WORKS
AT VLEIFONTEIN, VHEMBE DISTRICT**

Objective and Preparation (A2 - A14)

2	Offer, acceptance and performance (clause 2)	Fixed	Item
		Value Related	Item
		Time Related	Item
3	Documents (clause 3)		
	Clause 3.2.1 is amended by replacing "14.1" with "14.0"		
	Clause 3.7 is amended by the addition of the following:		
	The contractor shall supply and keep a copy of the JBCC Series 2000 Principal Building Agreement and Preliminaries applicable to this contract on the site , to which the employer, principal agent and agents shall have access at all times.		
	Clause 3.10 is amended by replacing the second reference to " principal agent " with the word " employer "		
		Fixed	Item
		Value Related	Item
		Time Related	Item
4	Design responsibility (clause 4)	Fixed	Item
		Value Related	Item
		Time Related	Item

Carried to Collection

R

Section No. 1
Bill No 1 - Preliminaries
LDPW-B/20151 - BILLS OF QUANTITIES

**CONSTRUCTION OF NEW LIBRARY
INCLUDING ELECTRICAL, MECHANICAL INSTALLATION
AND ASSOCIATED EXTERNAL WORKS
AT VLEIFONTEIN, VHEMBE DISTRICT**

5	Employer's agents (clause 5)	Fixed	Item		
		Value Related	Item		
		Time Related	Item		
6	Contractor's site representative (clause 6)	Fixed	Item		
		Value Related	Item		
		Time Related	Item		
7	Compliance with laws and regulations (clause 7) Note: A separate clause has been included in Section C: Specific Preliminaries of the bills of quantities for the contractor to have the opportunity to price for all the requirements of the Occupational Health and Safety Act, Construction Regulations and Health and Safety Specification	Fixed	Item		
		Value Related	Item		
		Time Related	Item		
8	Works risk (clause 8)	Fixed	Item		
		Value Related	Item		
		Time Related	Item		
Carried to Collection					
Section No. 1 Bill No 1 - Preliminaries LDPW-B/20151 - BILLS OF QUANTITIES				R	

**CONSTRUCTION OF NEW LIBRARY
INCLUDING ELECTRICAL, MECHANICAL INSTALLATION
AND ASSOCIATED EXTERNAL WORKS
AT VLEIFONTEIN, VHEMBE DISTRICT**

9 Indemnities (clause 9)

Clause 9.0 is amended by adding Clause 9.1.4:

The **contractor** indemnifies and holds harmless the **employer** against all liability, losses, claims, damages, penalties, actions, proceedings or judgements (collectively referred to as "Losses") arising from any infringement of letters, patent design, trademark, name, copyright or other protected rights in respect of any machine, plant, work, materials, thing, system or method of using, fixing, working or arrangement used or fixed or supplied by the **contractor**, but such indemnity shall not cover any use of the equipment of part thereof otherwise than in accordance with the provisions of the specification. All payments and royalties payable in one sum or by instalments or otherwise shall be included by the **contractor** in the price and shall be paid by him to those to whom they may be payable. The **contractor** shall reimburse the **employer** for all legal and other costs and expenses, including without limitation attorney's fees on attorney-client scale incurred by the **employer** in connection with investigation, defending or settling any Losses in connection with pending or threatening litigation in which the **employer** is a party.

Fixed

Item

Value Related

Item

Time Related

Item

10 Works insurances (clause 10)

Clause 10.0 is amended by the addition of the following clauses

10.5 Damage to the Works

(a) Without in any way limiting the **contractor's** obligations in terms of the contract, the **contractor** shall bear the full risk of damage to and/or destruction of the **works** by whatever cause during construction of the **works** and hereby indemnifies and holds harmless the

Carried to Collection

R

Section No. 1
Bill No 1 - Preliminaries
LDPW-B/20151 - BILLS OF QUANTITIES

**CONSTRUCTION OF NEW LIBRARY
INCLUDING ELECTRICAL, MECHANICAL INSTALLATION
AND ASSOCIATED EXTERNAL WORKS
AT VLEIFONTEIN, VHEMBE DISTRICT**

employer against any such damage. The **contractor** shall take such precautions and security measures and other steps for the protection and security of the **works** as the **contractor** may deem necessary

- b) The **contractor** shall at all times proceed immediately to remove or dispose of any debris arising from damage to or destruction of the **works** and to rebuild, restore, replace and/or repair the **works**
- (c) The **employer** shall carry the risk of damage to or destruction of the **works** and material paid for by the **employer** that is the result of the excepted risks as set out in 10.6
- (d) Where the **employer** bears the risk in terms of this contract, the **contractor** shall, if requested to do so, reinstate any damage or destroyed portions of the **works** and the costs of such reinstatement shall be measured and valued in terms of 32.0 hereof

10.6 Injury to Persons or loss of or damage to Properties

- (a) The **contractor** shall be liable for and hereby indemnifies the **employer** against any liability, loss, claim or proceeding whether arising in common law or by statute, consequent upon personal injuries to or the death of any person whomsoever arising out of or in the course of or caused by the execution of the **works** unless due to any act or neglect of any person for whose actions the **employer** is legally liable
- (b) The **contractor** shall be liable for and hereby indemnifies the **employer** against any liability, loss, claim or proceeding consequent upon loss of or damage to any moveable or immovable or personal property or property contiguous to the **site**, whether belonging to or under the control of the **employer** or any other body or person, arising out of or in the course of or by reason of the execution of the **works** unless due to any

Carried to Collection

R

Section No. 1
Bill No 1 - Preliminaries
LDPW-B/20151 - BILLS OF QUANTITIES

**CONSTRUCTION OF NEW LIBRARY
INCLUDING ELECTRICAL, MECHANICAL INSTALLATION
AND ASSOCIATED EXTERNAL WORKS
AT VLEIFONTEIN, VHEMBE DISTRICT**

- act or neglect of any person for whose actions the **employer** is legally liable
- c) The **contractor** shall, upon receiving a **contract instruction** from the **principal agent**, cause the same to be made good in a perfect and workmanlike manner at his own cost and in default thereof the **employer** shall be entitled to cause it to be made good and to recover the cost thereof from the **contractor** or to deduct the same from amounts due to the **contractor**
 - (d) The **contractor** shall be responsible for the protection and safety of such portions of the premises placed under his control by the **employer** for the purpose of executing the **works** until the issue of the **certificate of practical completion**
 - (e) Where the execution of the **works** involves the risk of removal of or interference with support to adjoining properties including land or structures or any structures to be altered or added to, the **contractor** shall obtain adequate insurance and will remain adequately insured or insured to the specific limit stated in the contract against the death of or injury to persons or damage to such property consequent on such removal or interference with the support until such portion of the **works** has been completed
 - (f) The **contractor** shall at all times proceed immediately at his own cost to remove or dispose of any debris and to rebuild, restore, replace and/or repair such property and to execute the **works**

10.7 High risk insurance

In the event of the project being executed in a geological area classified as a "High Risk Area", that is an area which is subject to highly unstable subsurface conditions that might result in catastrophic ground movement evident by sink-holes or doline formation the following will apply:

Carried to Collection

Section No. 1
Bill No 1 - Preliminaries
LDPW-B/20151 - BILLS OF QUANTITIES

R

**CONSTRUCTION OF NEW LIBRARY
INCLUDING ELECTRICAL, MECHANICAL INSTALLATION
AND ASSOCIATED EXTERNAL WORKS
AT VLEIFONTEIN, VHEMBE DISTRICT**

10.7.1 Damage to the works

The **contractor** shall, from the commencement **date** of the **works** until the date of the **certificate of practical completion** bear the full risk of and hereby indemnifies and holds harmless the **employer** against any damage to and/or destruction of the **works** consequent upon a catastrophic ground movement as mentioned above. The **contractor** shall take such precautions and security measures and other steps for the protection of the **works** as he may deem necessary

When so instructed to do so by the principal agent, the contractor shall proceed immediately to remove and/or dispose of any debris arising from damage to or destruction of the works and to rebuild, restore, replace and/or repair the works, at the contractor

10.7.2 Injury to persons or loss of or damage to property

The **contractor** shall be liable for and hereby indemnifies and holds harmless the **employer** against any liability, loss, claim or proceeding arising at any time during the period of the contract whether arising in common law or by statute, consequent upon personal injuries to or the death of any person whomsoever resulting from, arising out of or caused by a catastrophic ground movement as mentioned above

The **contractor** shall be liable for and hereby indemnifies the **employer** against any and all liability, loss, claim or proceeding consequent upon loss of or damage to any moveable or immovable or personal property or property contiguous to the **site**, whether belonging to or under the control of the **employer** or any other body or person whomsoever arising out of or caused by a catastrophic ground movement, as mentioned above, which occurred during the period of the contract

10.7.3 It is the responsibility of the **contractor** to ensure that he has adequate insurance to cover his risk and liability as mentioned in 10.7.1 and 10.7.2. Without limiting the **contractor's** obligations in terms of the contract, the **contractor** shall, within twenty-one (21)

Carried to Collection

Section No. 1
Bill No 1 - Preliminaries

LDPW-B/20151 - BILLS OF QUANTITIES

R

**CONSTRUCTION OF NEW LIBRARY
INCLUDING ELECTRICAL, MECHANICAL INSTALLATION
AND ASSOCIATED EXTERNAL WORKS
AT VLEIFONTEIN, VHEMBE DISTRICT**

calendar days of the **commencement date** but before commencement of the **works**, submit to the **employer** proof of such insurance policy, if requested to do so

10.7.4 The **employer** shall be entitled to recover any and all losses and/or damages of whatever nature suffered or incurred consequent upon the **contractor's** default of his obligations as set out in 10.7.1; 10.7.2 and 10.7.3. Such losses or damages may be recovered from the **contractor** or by deducting the same from any amounts still due under this contract or under any other contract presently or hereafter existing between the **employer** and the **contractor** and for this purpose all these contracts shall be considered one indivisible whole

		Fixed	Item	
		Value Related	Item	
		Time Related	Item	
11	Liability insurances (clause 11)			
		Fixed	Item	
		Value Related	Item	
		Time Related	Item	
12	Effecting insurances (clause 12)			
		Fixed	Item	
		Value Related	Item	
		Time Related	Item	
13	No clause (clause 13)		Item	

Carried to Collection

R

Section No. 1
Bill No 1 - Preliminaries
LDPW-B/20151 - BILLS OF QUANTITIES

**CONSTRUCTION OF NEW LIBRARY
INCLUDING ELECTRICAL, MECHANICAL INSTALLATION
AND ASSOCIATED EXTERNAL WORKS
AT VLEIFONTEIN, VHEMBE DISTRICT**

14 Security (clause 14)

Clause 14.0 is amended by:-

i) The addition of the following clauses:-

Clause 14.7.3

"Hand the site over to the **contractor** subject to agreement that shall be made between the **employer** and the **contractor**"

Fixed

Item

Value Related

Item

Time Related

Item

Carried to Collection

R

Section No. 1
Bill No 1 - Preliminaries
LDPW-B/20151 - BILLS OF QUANTITIES

**CONSTRUCTION OF NEW LIBRARY
INCLUDING ELECTRICAL, MECHANICAL INSTALLATION
AND ASSOCIATED EXTERNAL WORKS
AT VLEIFONTEIN, VHEMBE DISTRICT**

Execution (A15 - A23)

15 Preparation for and execution of the works (clause 15)

Clause 15.1.1 is amended by replacing it with:

No clause

Clause 15.1.2 is amended by replacing it with:

The **security** selected in terms of 14.0

Clause 15.1 is amended by the addition of the following clause:

15.1.4 An acceptable health and safety plan, required in terms of the Occupational Health and Safety Act, 1993 (Act 85 of 1993) or latest edition, revision and amendments, within twenty-one (21) **calendar days of commencement date**

Clause 15.2.1 is amended by replacing it with the following clause:

Give the **contractor** possession of the **site** within ten (10) **working days** of the **contractor** complying with the terms of 15.1

Fixed

Item

Value Related

Item

Time Related

Item

16 Access to the works (clause 16)

Fixed

Item

Value Related

Item

Time Related

Item

Carried to Collection

R

Section No. 1
Bill No 1 - Preliminaries
LDPW-B/20151 - BILLS OF QUANTITIES

**CONSTRUCTION OF NEW LIBRARY
INCLUDING ELECTRICAL, MECHANICAL INSTALLATION
AND ASSOCIATED EXTERNAL WORKS
AT VLEIFONTEIN, VHEMBE DISTRICT**

17	Contract instructions (clause 17)	Fixed	Item	
		Value Related	Item	
		Time Related	Item	
18	Setting out of the works (clause 18)			
	<p><i>The contractor shall notify the principal agent if any encroachments of adjoining foundations, buildings, structures, pavements, boundaries, etc. exist in order that the necessary arrangements may be made for the rectification of any such encroachments</i></p> <p><i>The contractor shall perform tolerance control checks regularly throughout the contract period and report on this at regular interval to the Principal Agent in the approved format. Should the contractor fail to comply with this requirement to the satisfaction of the Principal Agent, progressively as the structure is being constructed, the Employer will commission a Registered Land Surveyor to do so on the Contractor's behalf and at the Contractor's Expense.</i></p>			
		Fixed	Item	
		Value Related	Item	
		Time Related	Item	
19	Assignment (clause 19)			
		Fixed	Item	
		Value Related	Item	
		Time Related	Item	
Carried to Collection				R
Section No. 1 Bill No 1 - Preliminaries LDPW-B/20151 - BILLS OF QUANTITIES				

**CONSTRUCTION OF NEW LIBRARY
INCLUDING ELECTRICAL, MECHANICAL INSTALLATION
AND ASSOCIATED EXTERNAL WORKS
AT VLEIFONTEIN, VHEMBE DISTRICT**

20	<p>Nominated sub-contractors (clause 20)</p> <p>Clause 20.0</p> <p>Clause 20.1.3 is amended by replacing it with the following:</p> <p>No Clause</p>			
	Fixed		Item	
	Value Related		Item	
	Time Related		Item	
21	<p>Selected sub-contractors (clause 21)</p>			
	Fixed		Item	
	Value Related		Item	
	Time Related		Item	
22	<p>Employer's direct contractors (clause 22)</p> <p><i>The Contractor shall allow the direct contractors and employers agents access to the work, allocate reasonable space in the building for storage of their materials, tools and equipment, all to the satisfaction of the Principal Agent. The contractor shall also allow the direct contractors, etc. free of charge, use of their ablution facilities and water and power supply to the and shall in no way hinder or prevent the execution of their works. Attendance may be priced against the relevant specified items in the bills of quantities.</i></p>			
	Fixed		Item	
	Value Related		Item	
	Time Related		Item	
	Carried to Collection			R
	<p>Section No. 1 Bill No 1 - Preliminaries LDPW-B/20151 - BILLS OF QUANTITIES</p>			

**CONSTRUCTION OF NEW LIBRARY
INCLUDING ELECTRICAL, MECHANICAL INSTALLATION
AND ASSOCIATED EXTERNAL WORKS
AT VLEIFONTEIN, VHEMBE DISTRICT**

23	Contractor's domestic sub-contractors (Clause 23)	Fixed	Item	
		Value Related	Item	
		Time Related	Item	
	<u>COMPLETION</u>			
	<u>Completion (A24-A30)</u>			
24	Practical completion (clause 24)	Fixed	Item	
		Value Related	Item	
		Time Related	Item	
25	Works completion (clause 25)	Fixed	Item	
		Value Related	Item	
		Time Related	Item	
26	Final completion (clause 26)	Fixed	Item	
		Value Related	Item	
		Time Related	Item	
27	Latent defects liability period (clause 27)	Fixed	Item	
		Value Related	Item	
		Time Related	Item	
	Carried to Collection			R
Section No. 1 Bill No 1 - Preliminaries				

**CONSTRUCTION OF NEW LIBRARY
INCLUDING ELECTRICAL, MECHANICAL INSTALLATION
AND ASSOCIATED EXTERNAL WORKS
AT VLEIFONTEIN, VHEMBE DISTRICT**

LDPW-B/20151 - BILLS OF QUANTITIES

**CONSTRUCTION OF NEW LIBRARY
INCLUDING ELECTRICAL, MECHANICAL INSTALLATION
AND ASSOCIATED EXTERNAL WORKS
AT VLEIFONTEIN, VHEMBE DISTRICT**

28	<p>Sectional completion (clause 28)</p> <p style="text-align: right;">Fixed</p> <p style="text-align: right;">Value Related</p> <p style="text-align: right;">Time Related</p>	<p>Item</p> <p>Item</p> <p>Item</p>	
29	<p>Revision of date of practical completion (clause 29)</p> <p>Clause 29.1.1 shall be deemed to be omitted and replaced by the following:</p> <p>Inclement weather shall be defined as weather in excess of the average rainfall (volume and period) for each calendar month over the past ten (10) years as recorded by the nearest commonly recognised weather bureau in the region of the project</p> <p>It shall be deemed that the contractor has adequately allowed in his programme and tendered rates for expenses which might result from delays due to average or below rainfall as described above</p> <p style="padding-left: 40px;">Add Clause 29.9 as follows:</p> <p style="padding-left: 80px;">Revision to the date for practical completion shall only be considered when work on the critical path of the agreed programme for the works is delayed.”</p> <p>Add Clause 29.10 as follows:</p> <p>Clause 29.10 - Acceleration</p> <p style="padding-left: 40px;">Clause 29.10.1 Irrespective of whether or not the principal agent rules that the contractor is entitled to an extension of time or a revision of the date for practical completion, the principal agent shall nevertheless, at any time, be entitled to instruct the contractor in writing to accelerate the progress of the remaining works to ensure that the works are completed by the original date for practical completion or revised date as the case may be.</p>		
	Carried to Collection		R
	Section No. 1 Bill No 1 - Preliminaries		
	LDPW-B/20151 - BILLS OF QUANTITIES		

**CONSTRUCTION OF NEW LIBRARY
INCLUDING ELECTRICAL, MECHANICAL INSTALLATION
AND ASSOCIATED EXTERNAL WORKS
AT VLEIFONTEIN, VHEMBE DISTRICT**

Clause 29.10.2

Upon receipt of such instruction, the **contractor** shall take all necessary steps to ensure that the **works** are completed timeously including the provision by him of additional resources, plant, manpower, etc and the working overtime or additional overtime beyond that contemplated at the time of tender (at all times adhering to the regulations and requirements of all authorities) and by all other adequate and proper means and methods. The **contractor** shall prove that such steps are being taken if called upon to do so.

Clause 29.10.3

The **contractor's** entitlement to compensation arising out of or in respect of any revision to the date for **practical completion** that may have been granted by the **principal agent** or alternatively where the **principal agent** has instructed the **contractor** to accelerate, shall be adjudicated strictly in terms of clause 32.

Fixed

Item

Value Related

Item

Time Related

Item

30 Penalty for non-completion (clause 30)

Clause 30 is amended by replacing reference to 36.3 at end of sentence with 36.0

Fixed

Item

Value Related

Item

Time Related

Item

Carried to Collection

R

Section No. 1
Bill No 1 - Preliminaries
LDPW-B/20151 - BILLS OF QUANTITIES

**CONSTRUCTION OF NEW LIBRARY
INCLUDING ELECTRICAL, MECHANICAL INSTALLATION
AND ASSOCIATED EXTERNAL WORKS
AT VLEIFONTEIN, VHEMBE DISTRICT**

Payment (A31 - A35)

31 Interim payment to the contractor (clause 31)

Clause 31.9 is amended by replacing "seven (7) **calender** days" with "thirty (30) **calender** days" and by deleting the words "subject to the **contractor** giving the **employer** a tax invoice for the amount due"

Clause 31.12 is amended by deleting the following

Payment shall be subject to the **employer** giving the **contractor** a tax invoice for the amount due

Fixed

Item

Value Related

Item

Time Related

Item

32 Adjustment to the contract value (clause 32)

Clause 32.0

Clauses 32.5.1, 32.5.4 and 32.5.7 are amended by the addition of the following at the end of the sentence:

"due to no fault of the **contractor**"

Fixed

Item

Value Related

Item

Time Related

Item

33 Recovery of expense and loss (clause 33)

Fixed

Item

Value Related

Item

Time Related

Item

Carried to Collection

R

Section No. 1
Bill No 1 - Preliminaries
LDPW-B/20151 - BILLS OF QUANTITIES

**CONSTRUCTION OF NEW LIBRARY
INCLUDING ELECTRICAL, MECHANICAL INSTALLATION
AND ASSOCIATED EXTERNAL WORKS
AT VLEIFONTEIN, VHEMBE DISTRICT**

34	<p>Final account and final payment (clause 34)</p> <p>Clause 34.0</p> <p>Clause 34.2 is amended by inserting # next to 34.2</p> <p>Clause 34.13 is amended by replacing "seven (7) calendar days" with "thirty (30) calendar days" and deleting the words "subject to the employer giving the contractor a tax invoice for the amount due"</p>			
	Fixed			Item
	Value Related			Item
	Time Related			Item
35	<p>Payment to other parties (clause 35)</p>			
	Fixed			Item
	Value Related			Item
	Time Related			Item
Carried to Collection				R
<p>Section No. 1 Bill No 1 - Preliminaries LDPW-B/20151 - BILLS OF QUANTITIES</p>				

**CONSTRUCTION OF NEW LIBRARY
INCLUDING ELECTRICAL, MECHANICAL INSTALLATION
AND ASSOCIATED EXTERNAL WORKS
AT VLEIFONTEIN, VHEMBE DISTRICT**

Cancellation (A36-A39)

36 Cancellation by employer - contractor's default (clause 36)

Clause 36.1 is amended by the additions of the following clauses:

36.1.3 refuses or neglects to comply strictly with any of the conditions of contract

36.1.4 estate being sequestrated, liquidated or surrendered in terms of the insolvency laws in force within the Republic of South Africa

36.1.5 in the judgement of the **employer**, has engaged in **corrupt** or **fraudulent practices** in competing for or in executing the contract

Clause 36.3 is amended by removing the reference to "No clause" and replacing the words "**principal agent**" with "**employer**"

Clause 36.0 is amended by the addition of the following clause:

36.7 Notwithstanding any clause to the contrary, on cancellation of this **agreement** either by the **employer** or the **contractor**; or for any reason whatsoever, the **contractor** shall on written instruction, discontinue with the **works** on a date stated and withdraw himself from the **site**. The **contractor** shall not be entitled to refuse to withdraw from the **works** on the grounds of any lien or right of retention or on the grounds of any other right whatsoever

Fixed

Item

Value Related

Item

Time Related

Item

Carried to Collection

R

Section No. 1
Bill No 1 - Preliminaries
LDPW-B/20151 - BILLS OF QUANTITIES

**CONSTRUCTION OF NEW LIBRARY
INCLUDING ELECTRICAL, MECHANICAL INSTALLATION
AND ASSOCIATED EXTERNAL WORKS
AT VLEIFONTEIN, VHEMBE DISTRICT**

37 Cancellation by employer - loss and damage (clause 37)

Clause 37.3.5 is amended by replacing "ninety (90)" with "one-hundred and twenty (120)"

Clause 37.0 is amended by the addition of the following clause:

37.5 Notwithstanding any clause to the contrary, on cancellation of this **agreement** either by the **employer** or the **contractor**; or for any reason whatsoever, the **contractor** shall on written instruction, discontinue with the **works** on a date stated and withdraw himself from the **site**. The **contractor** shall not be entitled to refuse to withdraw from the **works** on the grounds of any lien or right of retention or on the grounds of any other right whatsoever

Fixed

Item

Value Related

Item

Time Related

Item

Carried to Collection

R

Section No. 1

Bill No 1 - Preliminaries

LDPW-B/20151 - BILLS OF QUANTITIES

**CONSTRUCTION OF NEW LIBRARY
INCLUDING ELECTRICAL, MECHANICAL INSTALLATION
AND ASSOCIATED EXTERNAL WORKS
AT VLEIFONTEIN, VHEMBE DISTRICT**

38	<p>Cancellation by contractor - employer's default (clause 38)</p> <p>Clause 38.5.4 is amended by replacing "ninety (90) with "one-hundred and twenty (120)"</p> <p>Clause 38.0 is amended by the addition of the following clause:</p> <p>38.7 Notwithstanding any clause to the contrary, on cancellation of this agreement either by the employer or the contractor; or for any reason whatsoever, the contractor shall on written instruction, discontinue with the works on a date stated and withdraw himself from the site. The contractor shall not be entitled to refuse to withdraw from the works on the grounds of any lien or right of retention or on the grounds of any other right whatsoever</p>			
	Fixed		Item	
	Value Related		Item	
	Time Related		Item	
39	<p>Cancellation - cessation of the works (clause 39)</p> <p>Clause 39.3.5 is amended by the addition of the following at the end of the sentence: "within one-hundred and twenty (120) working days of completion of such report"</p>			
	Fixed		Item	
	Value Related		Item	
	Time Related		Item	
	Carried to Collection			R
	<p>Section No. 1 Bill No 1 - Preliminaries LDPW-B/20151 - BILLS OF QUANTITIES</p>			

**CONSTRUCTION OF NEW LIBRARY
INCLUDING ELECTRICAL, MECHANICAL INSTALLATION
AND ASSOCIATED EXTERNAL WORKS
AT VLEIFONTEIN, VHEMBE DISTRICT**

Dispute Settlement (A40)

40 Disputes Settlement (clause 40)

Clause 40.2.2 is amended by replacing "one (1) year" with "three (3) years"

Clause 40.6 is amended by removing the reference to:

No clause

Clause 40.7.1 is amended by replacing "(10)" with "(15)" and by the addition of the following:

Whether or not mediation resolves the dispute, the parties shall bear their own cost concerning the mediation and equally share the costs of the mediator and related costs.

Fixed

Item

Value Related

Item

Time Related

Item

State Provision (A41)

41 State Substitutions (clause 41)

Delete in the Substitute Provisions (41.0 State Clauses) clauses 40.2.1, 40.2.2, 40.3, 40.4, 40.5 and 40.6 and replace with the following:

40.1 Should any dispute between the **employer**, his **agents** or **principal agent** on the one hand and the contractors on the other arise out of this **agreement**, such dispute shall be referred to adjudication.

40.2 Adjudication shall be conducted in accordance with the edition of the JBCC Rules for Adjudication current at the time when the dispute is declared. The party, which raises the dispute, shall select three adjudicators from the panel of adjudicators published by the South African Institution of Civil Engineering or Association of

Carried to Collection

R

Section No. 1

Bill No 1 - Preliminaries

LDPW-B/20151 - BILLS OF QUANTITIES

**CONSTRUCTION OF NEW LIBRARY
INCLUDING ELECTRICAL, MECHANICAL INSTALLATION
AND ASSOCIATED EXTERNAL WORKS
AT VLEIFONTEIN, VHEMBE DISTRICT**

Arbitrators (Southern Africa), determine their hourly fees and confirm that these adjudicators are available to adjudicate the dispute in question. The other party shall then select within 7 days one of the three nominated adjudicators, failing which the chairman for the time being of the Association of Arbitrators (Southern Africa) shall nominate an adjudicator. The **adjudicator** shall be appointed in terms of the Adjudicators Agreement set out in C1.4 .

40.3 If provided in the **schedule**, a dispute shall be finally settled by a single Arbitrator to be agreed on between the parties or, failing such agreement within 28 days after referring the dispute to Arbitration, an Arbitrator nominated by the chairman for the time being of the Association of Arbitrators (Southern Africa). Any such reference shall be deemed to be a submission to the arbitration of a single arbitrator in terms of the Arbitration Act (Act No 42 of 1965, as amended), or any legislation passed in substitution therefore. In the absence of any other agreed procedure, the arbitration shall take place in accordance with the Rules for the Conduct of Arbitrations issued by the Association of Arbitrators (Southern Africa) which are current at the time of the referral to arbitration. The Arbitrator shall, in his award, set out the facts and the provisions of the contract on which his award is based.

40.4 If the **schedule** provides for court proceedings to finally resolve disputes, disputes shall be determined by court proceedings.

Fixed

Item

Value Related

Item

Time Related

Item

Carried to Collection

R

Section No. 1
Bill No 1 - Preliminaries
LDPW-B/20151 - BILLS OF QUANTITIES

**CONSTRUCTION OF NEW LIBRARY
INCLUDING ELECTRICAL, MECHANICAL INSTALLATION
AND ASSOCIATED EXTERNAL WORKS
AT VLEIFONTEIN, VHEMBE DISTRICT**

Contract Variables (A41)

42 The Schedule (clause 42)

Tenderers are referred to the Contract Data and Notes to Tenderers for variable pertaining to this contract

Fixed

Item

Value Related

Item

Time Related

Item

SECTION B: PRELIMINARIES

Definition and interpretation (B1)

43 Definition and interpretation

See also clause A1.0 of Section A for additional and/or amended definitions which shall apply equally to this Section

Fixed

Item

Value Related

Item

Time Related

Item

Carried to Collection

R

Section No. 1
Bill No 1 - Preliminaries
LDPW-B/20151 - BILLS OF QUANTITIES

**CONSTRUCTION OF NEW LIBRARY
INCLUDING ELECTRICAL, MECHANICAL INSTALLATION
AND ASSOCIATED EXTERNAL WORKS
AT VLEIFONTEIN, VHEMBE DISTRICT**

Documents (B2)

44 Checking of documents (B2.1)

These bills of quantities:

(1) contain pages and annexes as indexed, and;

(2) are in multiple procurement format, i.e. all trades are fully measured with minor budgetary allowances

Items in these bills of quantities are to be read and priced in conjunction with and the descriptions regarded as amplified by the Model Preambles for Trades, 2008 edition, as recommended and published by the Association of South African Quantity Surveyors and no claim arising from brevity of description of items fully described in the said Model Preambles for Trades will be entertained

Fixed

Item

Value Related

Item

Time Related

Item

45 Provisional bills of quantities (B2.2)

Fixed

Item

Value Related

Item

Time Related

Item

Carried to Collection

R

Section No. 1
Bill No 1 - Preliminaries
LDPW-B/20151 - BILLS OF QUANTITIES

**CONSTRUCTION OF NEW LIBRARY
INCLUDING ELECTRICAL, MECHANICAL INSTALLATION
AND ASSOCIATED EXTERNAL WORKS
AT VLEIFONTEIN, VHEMBE DISTRICT**

46	Availability of construction documentation (B2.3)				
	<i>The minor budgetary allowances included in this document will be separately procured, based on multiple procurement of selected sub-contractors during the construction period</i>				
		Fixed	Item		
		Value Related	Item		
		Time Related	Item		
47	Interests of agents (B2.4)				
		Fixed	Item		
		Value Related	Item		
		Time Related	Item		
48	Priced documents (B2.5)				
		Fixed	Item		
		Value Related	Item		
		Time Related	Item		
49	Tender submission (B2.6)				
	<i>Notwithstanding anything contained in this clause tenders shall be valid for a period of ninety (90) days from the closing date of tenders</i>				
	<i>Clause 2.6 is amended by replacing "JBCC Form of Tender" with "Form of Offer and Acceptance C1.1"</i>				
		Fixed	Item		
		Value Related	Item		
		Time Related	Item		
	Carried to Collection				R
	Section No. 1				
	Bill No 1 - Preliminaries				
	LDPW-B/20151 - BILLS OF QUANTITIES				

**CONSTRUCTION OF NEW LIBRARY
INCLUDING ELECTRICAL, MECHANICAL INSTALLATION
AND ASSOCIATED EXTERNAL WORKS
AT VLEIFONTEIN, VHEMBE DISTRICT**

<u>The site (B3)</u>				
50	Defined works area (B3.1)	Fixed	Item	
		Value Related	Item	
		Time Related	Item	
51	Geotechnical investigation (B3.2)	Fixed	Item	
		Value Related	Item	
		Time Related	Item	
52	Inspection of the site (B3.3)			
	<i>Tenderers are instructed to familiarise themselves before submission of their tender with regard to the relevant local site conditions, site accessibility, the nature of operations required, availability of labour and any conditions pertaining thereto, together with conditions relating to unloading, carting and storage of materials, equipment and tools required for the works.</i>			
	<i>No claims for extras arising from the contractor having failed to comply with this clause will be entertained</i>			
		Fixed	Item	
		Value Related	Item	
		Time Related	Item	
53	Existing premises occupied (B3.4)	Fixed	Item	
		Value Related	Item	
		Time Related	Item	
Carried to Collection				R
Section No. 1				
Bill No 1 - Preliminaries				
LDPW-B/20151 - BILLS OF QUANTITIES				

**CONSTRUCTION OF NEW LIBRARY
INCLUDING ELECTRICAL, MECHANICAL INSTALLATION
AND ASSOCIATED EXTERNAL WORKS
AT VLEIFONTEIN, VHEMBE DISTRICT**

54	Previous work - dimensional accuracy (B3.5) <i>Work executed under a previous contract and the extent thereof will be pointed out to the contractor by the principal agent on handing over of the site</i>			
	Fixed		Item	
	Value Related		Item	
	Time Related		Item	
55	Previous work - defects (B3.6)			
	Fixed		Item	
	Value Related		Item	
	Time Related		Item	
56	Services - known (B3.7)			
	Fixed		Item	
	Value Related		Item	
	Time Related		Item	
57	Services - unknown (B3.8)			
	Fixed		Item	
	Value Related		Item	
	Time Related		Item	
58	Protection of trees, etc (B3.9)			
	Fixed		Item	
	Value Related		Item	
	Time Related		Item	
Carried to Collection				R
Section No. 1 Bill No 1 - Preliminaries				

**CONSTRUCTION OF NEW LIBRARY
INCLUDING ELECTRICAL, MECHANICAL INSTALLATION
AND ASSOCIATED EXTERNAL WORKS
AT VLEIFONTEIN, VHEMBE DISTRICT**

LDPW-B/20151 - BILLS OF QUANTITIES

**CONSTRUCTION OF NEW LIBRARY
INCLUDING ELECTRICAL, MECHANICAL INSTALLATION
AND ASSOCIATED EXTERNAL WORKS
AT VLEIFONTEIN, VHEMBE DISTRICT**

59	Articles of value (B3.10)	Fixed	Item		
		Value Related	Item		
		Time Related	Item		
60	Inspection of adjoining properties, etc (B3.11)	Fixed	Item		
		Value Related	Item		
		Time Related	Item		
	<u>Management of contract (B4)</u>				
61	Management of the works (B4.1)	Fixed	Item		
		Value Related	Item		
		Time Related	Item		
62	Programming for the works (B4.2)				
	Clause B4.2 is hereby amended by the addition of the following:				
	Programme:				
	The contractor and the principal agent shall agree to a Contract Programme for the control of the Works.				
	The contractor shall submit a draft of the Contract Programme and method statement to the principal agent for approval together with the tender.				
	The contractor shall ensure that the contract programme:				
	1. Shall be prepared and drawn up to comply in all respects with the requirements of this Agreement.				
	2. shall be drawn up using logic developed during				
	Carried to Collection				
	Section No. 1				
	Bill No 1 - Preliminaries				
	LDPW-B/20151 - BILLS OF QUANTITIES				
				R	

**CONSTRUCTION OF NEW LIBRARY
INCLUDING ELECTRICAL, MECHANICAL INSTALLATION
AND ASSOCIATED EXTERNAL WORKS
AT VLEIFONTEIN, VHEMBE DISTRICT**

- the tender period and complies with the planning requirements of the Client.
3. shall be in accordance with the dates given herein for possession and practical completion; and
 4. shall be in sufficient and approved detail to ensure effective control of the work, including all items necessary to enable calculations to be made for the distribution of finance during the cash flow analysis.
 5. shall be accompanied by a full written method statement

The principal agent shall examine and comment on the contract programme and method statement within two weeks of its submission.

Following on these comments the contractor shall amend the contract programme and method statement as may be necessary and submit the final contract programme and method statement to the principal agent for approval within a further two weeks thereafter.

The contract programme shall be processed by computer and be presented to the principal agent in the form of logic charts and bar charts in such a way as to determine the critical path and the float on non-critical activities. All supporting printouts must be available to the principal agent on demand.

The acceptance by the principal agent of the contract programme, or any revision thereof, does not necessarily sanction the accuracy of validity of the network logic, the correctness of individual activities in terms of description or duration, the comprehensiveness of networks or the discrepancies between drawings and any other documents presented by the contractor, and in no way relieves the responsibility of the contractor to comply with the requirements of the Agreement.

No policy decisions other than the planning requirements, procedures and policies provided, will be enforced on the contractor regarding construction of the project and the contractor shall be responsible at all times for ensuring the accuracy, validity and reasonableness of programming information.

Carried to Collection

Section No. 1
Bill No 1 - Preliminaries
LDPW-B/20151 - BILLS OF QUANTITIES

R

**CONSTRUCTION OF NEW LIBRARY
INCLUDING ELECTRICAL, MECHANICAL INSTALLATION
AND ASSOCIATED EXTERNAL WORKS
AT VLEIFONTEIN, VHEMBE DISTRICT**

Documentation will not be available in complete detail at the date of award of the contract. Non-availability of information will not be deemed an excuse for non-presentation of programmes. In the event of inadequate information, the contractor shall estimate the predicted time applications on available information and quality the submission accordingly.

Development of the contract programme and method statement

Within two weeks of award of the contract, the contractor shall submit an updated contract programme and written method statement which shall include the latest information in sufficient detail to permit comprehensive monitoring.

Progress of the works will be monitored by the principal agent. The contractor shall liaise with the principal agent in order to provide whatever information is required to facilitate such monitoring.

Revisions to the contract programme

Revisions to the contract programme may be introduced periodically by the contractor subject to compliance with the contract completion and handover dates.

Providing the required consultation between the relevant parties has highlighted the implications of the required changes, the programming strategy on the project may be changed and the changes noted and specified on logic charts delivered to the principal agent. The changes to the programme will be recorded as firm and binding once the principal agent has sanctioned the said changes.

A revision to the programme will not invalidate the contractual completion dates and applications for extensions of time will be processed by the principal agent in accordance with the conditions of contract.

Should the contractor fail to submit a request for revision to the construction programme , progress monitoring shall be based on the latest revised programme sanctioned by the principal agent.

Carried to Collection

Section No. 1
Bill No 1 - Preliminaries
LDPW-B/20151 - BILLS OF QUANTITIES

R

**CONSTRUCTION OF NEW LIBRARY
INCLUDING ELECTRICAL, MECHANICAL INSTALLATION
AND ASSOCIATED EXTERNAL WORKS
AT VLEIFONTEIN, VHEMBE DISTRICT**

The contractor shall make all his necessary revisions on the approved network sheets clearly marking, inter-alia, the logic changes and duration changes. These will then be processed by the necessary parties and then approved in the normal manner

Progress Monitoring

The contractor shall provide regular progress reports showing actual and expected progress against the latest contract programme. Progress reports shall be submitted at each site progress meeting and shall outline the progress against key target dates and deviation which has occurred against the most recently updated control programme due to the progress reflected in the as-built construction programme.

The status of each activity must also be reported as follows:

Target - If the activity is not complete, the latest predicted completion date shall be supplied.

Start - If the activity has commenced, the actual date shall be supplied.

Finish - If the activity is complete, the actual completion date shall be supplied.

Problems which may occur during execution of the contract must be specifically identified in progress reports under a separate section of the contractor's report.

Should problems occur during the execution of the contract or the scope of work be increased or decreased, the contractor may be requested to increase the extent or the detail of the programme.

The principal agent may recommend action to be taken by the contractor, including the revision of resource levels, but this information will not be binding on the contractor unless the recommendations are enforced in terms of the conditions of contract by the principal agent and will in no way relieve the contractor's responsibility

Carried to Collection

Section No. 1
Bill No 1 - Preliminaries
LDPW-B/20151 - BILLS OF QUANTITIES

R

**CONSTRUCTION OF NEW LIBRARY
INCLUDING ELECTRICAL, MECHANICAL INSTALLATION
AND ASSOCIATED EXTERNAL WORKS
AT VLEIFONTEIN, VHEMBE DISTRICT**

to comply with the requirements of the Agreement.

Extension of time

Any extension of time which is granted by the principal agent will be annotated to affect selected activities in the programme and the associated activities will be incorporated by revisions to the programme by the contractor. Should the additional activities or the extension of time on existing activities fall on a non-critical area of the programme, extension will be limited to the activities affected by the said additional activities or extensions and the contract dates shall not be affected. If, however, the additional activities fall on the critical path, the principal agent shall take this into account when granting any extension of time in terms of the conditions of contract.

The contractor agrees that the contract completion date (i.e. the date for practical completion) has been stipulated in the contract for the benefit of the employer, so that, without derogating from the generality of the afore going principle it is provide that:

1. The contractor shall not be entitled to deliver the site and the works to the employer prior to the contract completion date and
2. Should there for any reason be any float period indicated in the contract programme prior to the contractual completion date then this float period shall be utilized to absorb any delays or extensions of time without affecting the contract completion date.
3. The contractor shall, at all times, ensure that, notwithstanding the approval or sanctioning, reviewing or inspection of a programme or any revision of a programme by the principal agent in the afore going terms, practical completion and completion of the works shall take place strictly in accordance with this Agreement.

A defective or faulty programme, even if so sanctioned, approved, reviewed or inspected by the principal agent, shall therefore not constitute a cause for granting an

Carried to Collection

Section No. 1
Bill No 1 - Preliminaries
LDPW-B/20151 - BILLS OF QUANTITIES

R

**CONSTRUCTION OF NEW LIBRARY
INCLUDING ELECTRICAL, MECHANICAL INSTALLATION
AND ASSOCIATED EXTERNAL WORKS
AT VLEIFONTEIN, VHEMBE DISTRICT**

extension of time for completion of the works or for entitling the contractor to the payment by the employer in terms of the contract of any loss, compensation or damage whatsoever.

The contractor acknowledges that the principal agent's afore going participation in the approval of development of, revisions to and updating of the Contract Programme shall take place in consultation with the principal agent. The contractor shall therefore provide the principal agent with such co-operation and/or information and/or access as they may reasonably require for such purposes.

		Fixed	Item		
		Value Related	Item		
		Time Related	Item		
63	Progress meetings (B4.3)	Fixed	Item		
		Value Related	Item		
		Time Related	Item		
64	Technical meetings (B4.4)	Fixed	Item		
		Value Related	Item		
		Time Related	Item		
65	Labour and plant records (B4.5)	Fixed	Item		
		Value Related	Item		
		Time Related	Item		

Carried to Collection

R

Section No. 1
Bill No 1 - Preliminaries
LDPW-B/20151 - BILLS OF QUANTITIES

**CONSTRUCTION OF NEW LIBRARY
INCLUDING ELECTRICAL, MECHANICAL INSTALLATION
AND ASSOCIATED EXTERNAL WORKS
AT VLEIFONTEIN, VHEMBE DISTRICT**

<u>Samples, shop drawings and manufacturer's instructions (B5)</u>					
66	Samples of materials (B5.1)	Fixed	Item		
		Value Related	Item		
		Time Related	Item		
67	Workmanship samples (B5.2)	Fixed	Item		
		Value Related	Item		
		Time Related	Item		
68	Shop drawings (B5.3)	Fixed	Item		
		Value Related	Item		
		Time Related	Item		
69	Compliance with manufacturer's instructions (B5.4)	Fixed	Item		
		Value Related	Item		
		Time Related	Item		
<u>Temporary works and plant (B6)</u>					
70	Deposits and fees (B6.1)	Fixed	Item		
		Value Related	Item		
		Time Related	Item		
Carried to Collection					R

Section No. 1
Bill No 1 - Preliminaries

**CONSTRUCTION OF NEW LIBRARY
INCLUDING ELECTRICAL, MECHANICAL INSTALLATION
AND ASSOCIATED EXTERNAL WORKS
AT VLEIFONTEIN, VHEMBE DISTRICT**

LDPW-B/20151 - BILLS OF QUANTITIES

**CONSTRUCTION OF NEW LIBRARY
INCLUDING ELECTRICAL, MECHANICAL INSTALLATION
AND ASSOCIATED EXTERNAL WORKS
AT VLEIFONTEIN, VHEMBE DISTRICT**

71	Enclosure of the works (B6.2)	Fixed	Item		
		Value Related	Item		
		Time Related	Item		
72	Advertising (B6.3)	Fixed	Item		
		Value Related	Item		
		Time Related	Item		
73	Plant, equipment, sheds and offices (B6.4)	Fixed	Item		
		Value Related	Item		
		Time Related	Item		
74	Main notice board (B6.5)	Fixed	Item		
		Value Related	Item		
		Time Related	Item		
75	Subcontractors notice board (B6.6)	Fixed	Item		
		Value Related	Item		
		Time Related	Item		
Carried to Collection					R
Section No. 1 Bill No 1 - Preliminaries					

**CONSTRUCTION OF NEW LIBRARY
INCLUDING ELECTRICAL, MECHANICAL INSTALLATION
AND ASSOCIATED EXTERNAL WORKS
AT VLEIFONTEIN, VHEMBE DISTRICT**

LDPW-B/20151 - BILLS OF QUANTITIES

**CONSTRUCTION OF NEW LIBRARY
INCLUDING ELECTRICAL, MECHANICAL INSTALLATION
AND ASSOCIATED EXTERNAL WORKS
AT VLEIFONTEIN, VHEMBE DISTRICT**

<u>Temporary services (B7)</u>					
76	Location (B7.1)	Fixed	Item		
		Value Related	Item		
		Time Related	Item		
77	Water (B7.2)	Fixed	Item		
		Value Related	Item		
		Time Related	Item		
78	Electricity (B7.3)	Fixed	Item		
		Value Related	Item		
		Time Related	Item		
79	Telecommunication facilities (B7.4)	Fixed	Item		
		Value Related	Item		
		Time Related	Item		
80	Ablution facilities (B7.5)	Fixed	Item		
		Value Related	Item		
		Time Related	Item		
Carried to Collection				R	

Section No. 1
Bill No 1 - Preliminaries

**CONSTRUCTION OF NEW LIBRARY
INCLUDING ELECTRICAL, MECHANICAL INSTALLATION
AND ASSOCIATED EXTERNAL WORKS
AT VLEIFONTEIN, VHEMBE DISTRICT**

LDPW-B/20151 - BILLS OF QUANTITIES

**CONSTRUCTION OF NEW LIBRARY
INCLUDING ELECTRICAL, MECHANICAL INSTALLATION
AND ASSOCIATED EXTERNAL WORKS
AT VLEIFONTEIN, VHEMBE DISTRICT**

	<u>Prime cost amounts (B8)</u>			
81	Responsibility for prime cost amounts (B8.1)	Fixed	Item	
		Value Related	Item	
		Time Related	Item	
	<u>Attendance on nominated and selected subcontractors (B9)</u>			
82	General attendance (B9.1)			
	The schedule rates providing for attendance on nominated subcontractors and other contractors , will be adjusted only if the scope of the work has changed	Fixed	Item	
		Value Related	Item	
		Time Related	Item	
83	Special attendance (B9.2)	Fixed	Item	
		Value Related	Item	
		Time Related	Item	
84	Commissioning - Fuel, water and electricity (B9.3)	Fixed	Item	
		Value Related	Item	
		Time Related	Item	
	Carried to Collection			R
	Section No. 1			
	Bill No 1 - Preliminaries			
	LDPW-B/20151 - BILLS OF QUANTITIES			

**CONSTRUCTION OF NEW LIBRARY
INCLUDING ELECTRICAL, MECHANICAL INSTALLATION
AND ASSOCIATED EXTERNAL WORKS
AT VLEIFONTEIN, VHEMBE DISTRICT**

<u>Financial aspects (B10)</u>				
85	Statutory taxes, duties and levies (B10.1)			
	<i>Provision is made in the summary of these bills of quantities for the inclusion of Value Added Tax (VAT)</i>			
		Fixed	Item	
		Value Related	Item	
		Time Related	Item	
86	Payment of preliminaries (B10.2)			
		Fixed	Item	
		Value Related	Item	
		Time Related	Item	
87	Adjustment of preliminaries (B10.3)			
	Clauses B10.3.1 and B10.3.2 are amended by replacing "within fifteen (15) working days of taking possession of the site " with "when submitting his priced bills of quantities "			
		Fixed	Item	
		Value Related	Item	
		Time Related	Item	
88	Payment certificate cash flow (B10.4)			
		Fixed	Item	
		Value Related	Item	
		Time Related	Item	
Carried to Collection				
				R
Section No. 1 Bill No 1 - Preliminaries LDPW-B/20151 - BILLS OF QUANTITIES				

**CONSTRUCTION OF NEW LIBRARY
INCLUDING ELECTRICAL, MECHANICAL INSTALLATION
AND ASSOCIATED EXTERNAL WORKS
AT VLEIFONTEIN, VHEMBE DISTRICT**

<u>General (B11)</u>				
89	Protection of works (B11.1)	Fixed	Item	
		Value Related	Item	
		Time Related	Item	
90	Protection/isolation of existing/sectionally occupied works(B11.2)	Fixed	Item	
		Value Related	Item	
		Time Related	Item	
91	Site security (B11.3)	Fixed	Item	
		Value Related	Item	
		Time Related	Item	
92	Notice before covering work (B11.4)	Fixed	Item	
		Value Related	Item	
		Time Related	Item	
93	Disturbance (B11.5)	Fixed	Item	
		Value Related	Item	
		Time Related	Item	
Carried to Collection				R
Section No. 1				
Bill No 1 - Preliminaries				

**CONSTRUCTION OF NEW LIBRARY
INCLUDING ELECTRICAL, MECHANICAL INSTALLATION
AND ASSOCIATED EXTERNAL WORKS
AT VLEIFONTEIN, VHEMBE DISTRICT**

LDPW-B/20151 - BILLS OF QUANTITIES

**CONSTRUCTION OF NEW LIBRARY
INCLUDING ELECTRICAL, MECHANICAL INSTALLATION
AND ASSOCIATED EXTERNAL WORKS
AT VLEIFONTEIN, VHEMBE DISTRICT**

94	Environmental disturbance (B11.6)	Fixed	Item		
		Time Related	Item		
		Value Related	Item		
95	Works cleaning and clearing (B11.7)	Fixed	Item		
		Value Related	Item		
		Time Related	Item		
96	Vermin (B11.8)	Fixed	Item		
		Value Related	Item		
		Time Related	Item		
97	Overhand work (B11.9)	Fixed	Item		
		Value Related	Item		
		Time Related	Item		
98	Instruction manuals and guarantees (B11.10)	Fixed	Item		
		Value Related	Item		
		Time Related	Item		
99	As built information (B11.11)	Fixed	Item		
		Value Related	Item		
		Time Related	Item		
		Carried to Collection			R

Section No. 1

**CONSTRUCTION OF NEW LIBRARY
INCLUDING ELECTRICAL, MECHANICAL INSTALLATION
AND ASSOCIATED EXTERNAL WORKS
AT VLEIFONTEIN, VHEMBE DISTRICT**

Bill No 1 - Preliminaries
LDPW-B/20151 - BILLS OF QUANTITIES

**CONSTRUCTION OF NEW LIBRARY
INCLUDING ELECTRICAL, MECHANICAL INSTALLATION
AND ASSOCIATED EXTERNAL WORKS
AT VLEIFONTEIN, VHEMBE DISTRICT**

100	Tenant installations (B11.12) <div style="text-align: right; margin-top: 10px;">Fixed</div> <div style="text-align: right; margin-top: 10px;">Value Related</div> <div style="text-align: right; margin-top: 10px;">Time Related</div>		Item		
	<u>Schedule of variables (B12)</u>				
101	Pre-tender information (B12.1) <p style="margin-top: 10px;">This schedule contains all variables referred to in this document and is divided into pretender and post-tender categories. The pre-tender category must be completed in full and included in the tender documents. Both the pre-tender and post-tender categories form part of these Preliminaries.</p> <div style="text-align: right; margin-top: 10px;">Fixed</div> <div style="text-align: right; margin-top: 10px;">Value Related</div> <div style="text-align: right; margin-top: 10px;">Time Related</div>		Item		
	12.1.1 Provisional bills of quantities (B12.1.1) <p style="margin-top: 10px;">The quantities are provisional:</p> <div style="text-align: right; margin-top: 10px;">Yes</div>				
	12.1.2 Availability of construction documentation (B12.1.2) <p style="margin-top: 10px;">Construction documentation is complete:</p> <div style="text-align: right; margin-top: 10px;">Yes</div>				
	Carried to Collection				R
	Section No. 1 Bill No 1 - Preliminaries LDPW-B/20151 - BILLS OF QUANTITIES				

**CONSTRUCTION OF NEW LIBRARY
INCLUDING ELECTRICAL, MECHANICAL INSTALLATION
AND ASSOCIATED EXTERNAL WORKS
AT VLEIFONTEIN, VHEMBE DISTRICT**

12.1.3.1	<p>Employer: Department of Public Works - Limpopo Provincial Government 43 Church Street, Polokwane, 0700 Private Bag X9490, Polokwane, 0700 Tel: (015) 284 7219 Fax: (015) 284 7030 Email: malulekev@dpw.limpopo.gov.za</p>			
12.1.3.2	<p>Principal Agent/Architect: LEMEG Architects 45 Bendor Drive, Polokwane, 0700 Postnet Suite 45, Private Bag X9676, Polokwane, 0700 Tel: (015) 296 4351 Fax: (015) 296 4359 Contact: Email: admin@lemeg.com;</p>			
12.1.3.3	<p>Quantity Surveyor: MM Sakonda and Associates 15 Paul Kruger Str. Polokwane, 0700 PO Box 4785, Polokwane, 0700 Tel: (015) 291 5662 Fax: (015) 291 5740 Contact: Email: thembam@mm-sakonda.com</p>			
12.1.3.4	<p>Civil Engineers: SMEC Tiro House, 7 Rhodesdrift Str. Bendor, 0699 Tel: (015) 296 1138 Fax: (015) 296 0330 Contact: Email: erlo.dewaal@smec.com</p>			
12.1.3.5	<p>Structural Engineers: KTN Consulting Engineers and Project Managers Thornhill Office Park, Building 27, Suite F9 94 Bekker Road, Midrand, Midrad, 1686 Tel: (011) 805 0981 Fax: Contact: Email: ktn@ktnconsulting.co.za</p>			
12.1.3.6	<p>Mechanical Engineers: Superior Quality Engineering 60 Magazyn Str. Polokwane, 0700</p>			
Carried to Collection				R
Section No. 1 Bill No 1 - Preliminaries LDPW-B/20151 - BILLS OF QUANTITIES				

**CONSTRUCTION OF NEW LIBRARY
INCLUDING ELECTRICAL, MECHANICAL INSTALLATION
AND ASSOCIATED EXTERNAL WORKS
AT VLEIFONTEIN, VHEMBE DISTRICT**

Tel: (015) 295 5750 Fax: (086) 514 8513

Contact:

Email: admin@superiorqengineers.com

12.1.3.7

Geotechnical:

Diges Group

98 Marshall Str. Polokwane, 0700

Tel: (015) 291 4151 Fax:

Contact:

Email: info@diges.co.za

12.1.3.7

Geotechnical:

Phathaxon Engineers

19 Mohlopi Str. Flora Park, Polokwane,
0700

Tel: (078) 476 3138 Fax:

Contact:

Email: mpatenit@yahoo.com

12.1.4 Defined works area (B12.1.4)

The works described in these Bills of Quantities comprises the Construction of New Library Building at Vleifontein In the Vhembe District.

The buildings are single storey with bricks, face brick walls externally plastered and painted walls internally, ceilings and roof sheeting on steel trusses.

The works also includes Electrical Installations, Mechanical Installation and Civil Works that includes Roadworks, water reticulation and sewer reticulation.

12.1.5 Geotechnical investigation (B12.1.5)

The geotechnical report is available for viewing at the offices of the Principal Agent

Yes

Carried to Collection

R

Section No. 1

Bill No 1 - Preliminaries

LDPW-B/20151 - BILLS OF QUANTITIES

**CONSTRUCTION OF NEW LIBRARY
INCLUDING ELECTRICAL, MECHANICAL INSTALLATION
AND ASSOCIATED EXTERNAL WORKS
AT VLEIFONTEIN, VHEMBE DISTRICT**

12.1.6 **Existing premises occupied (B12.1.6)**

[3.4] Specific requirements:
The contractor shall execute the works with as little noise and disturbance as possible

12.1.7 Previous work - Dimensional accuracy (B12.1.7)

[3.5] Details:
No additional details

No

12.1.8 **Previous work - defects**

[3.6] Details:
No additional details

12.1.9 Services - known (B12.1.9)

Existing services and points of connection are shown on the site plan and/or will be pointed out on site by the principal agent

12.1.10 **Protection of trees**

[3.9] Specific requirements:
No trees to be damaged or removed except those specifically designated in writing by the Architect

12.1.11 **Inspection of adjoining properties**

[3.11] Specific requirements:
None

12.1.12 **Enclosure of the works**

[6.2] Specific requirements:
Areas where work is taking place shall at all times be blocked off by appropriate means

Carried to Collection

R

Section No. 1
Bill No 1 - Preliminaries
LDPW-B/20151 - BILLS OF QUANTITIES

12.1.13 Offices

[6.4.3] Specific requirements:

The contractor shall provide, maintain and remove on completion of the works an office for the exclusive use of the principal agent, minimum size 4m x 3m x 3m high internally, suitably insulated and ventilated, provided with electric lighting and fitted with boarded floor, desk, chair, drawing stool, drawing board and lock-up drawers for drawings. The office shall be kept clean and fit for use at all times.

The contractor to also provide a board room suitable for 15 people seated and his office site office(s) with suitably insulated and ventilated, provided with electric lighting and fitted with boarded floor, desk, chair, drawing stool, drawing board and lock-up drawers for drawings. The office shall be kept clean and fit for use at all times.

12.1.14 Main notice board

[6.5] Specific requirements:

The contractor shall provide, erect where directed, maintain and remove on completion of the works a notice board size 3m x 3m constructed of suitable boarding with flat smooth surface and with edging bead 19mm thick round outer edges and projecting 12mm from face of boarding and rounded on front edge. The board shall be securely fixed to hoarding, where hoarding is provided, or fixed to and including a suitable supporting structure of timber or tubular posts and braces. The board is to be painted ivory white and the bead and 12mm wide dividing lines dark green. All wording shall be inscribed in dark green as per the coat of arms for SA. All wording shall be inscribed in dark green painted sans serif lettering.

Carried to Collection

R

**CONSTRUCTION OF NEW LIBRARY
INCLUDING ELECTRICAL, MECHANICAL INSTALLATION
AND ASSOCIATED EXTERNAL WORKS
AT VLEIFONTEIN, VHEMBE DISTRICT**

<p>12.1.15 Subcontractors' notice board</p> <p>[6.6] A notice board is required (yes/no) NO Specific requirements:</p> <p>12.1.16 Water</p> <p>[7.2] Option A (by contractor) (yes/no) YES</p> <p>12.1.17 Electricity</p> <p>[7.3] Option A (by contractor) (yes/no) YES</p> <p>12.1.18 Telecommunications</p> <p>[7.4] Telephone (yes/no) YES</p> <p>Facsimile (yes/no) YES</p> <p>E-mail (yes/no) YES</p> <p>12.1.19 Ablution facilities</p> <p>[7.5] Option A (by contractor) (yes/no) YES</p> <p>Option B (by employer) (yes/no) NO</p> <p>12.1.20 Protection of existing/sectionally occupied works</p> <p>[11.2] Protection is required (yes/no) YES</p>				
Carried to Collection				R
<p>Section No. 1 Bill No 1 - Preliminaries LDPW-B/20151 - BILLS OF QUANTITIES</p>				

**CONSTRUCTION OF NEW LIBRARY
INCLUDING ELECTRICAL, MECHANICAL INSTALLATION
AND ASSOCIATED EXTERNAL WORKS
AT VLEIFONTEIN, VHEMBE DISTRICT**

12.1.21 **Special attendance**

The contractor must obtain information from all subcontractors at tender stage regarding special attendance that might be required and make allowance for each and every subcontract that requires special attendance

[9.2] **Subcontractor (1) Details:**

Subcontractor (2) Details:

Subcontractor (3) Details:

12.1.22 **Protection of the works**

[11.1] Specific requirements:
All work that requires protection during construction must be adequately protected up to practical completion by the **contractor**

12.1.23 **Disturbance**

[11.5] Specific requirements:
The **contractor** shall keep the site, structures, etc., well watered during operations to prevent dust and shall provide and erect and remove on completion of the **works** all necessary temporary dust screens all to the satisfaction of the **principal agent**

12.1.24 **Environmental disturbance**

[11.6] Specific requirements:
None

102 Post-tender information (B12.2)

All post-tender information for this section will be determined once tender is awarded

Fixed

Item

Carried to Collection

R

Section No. 1
Bill No 1 - Preliminaries

LDPW-B/20151 - BILLS OF QUANTITIES

**CONSTRUCTION OF NEW LIBRARY
INCLUDING ELECTRICAL, MECHANICAL INSTALLATION
AND ASSOCIATED EXTERNAL WORKS
AT VLEIFONTEIN, VHEMBE DISTRICT**

		Value Related		Item
		Time Related		Item
	12.2.1 Payment of preliminaries			
	[10.2] Option A (prorated) YES	(yes/no)		
	Option B (calculated) NO	(yes/no)		
	12.2.2 Adjustment of preliminaries			
	[10.3] Option A (three categories) YES	(yes/no)		
	Option B (detailed breakdown) NO	(yes/no)		
	12.2.3 Additional agreed preliminaries items			
	Details: None			
103	Other post tender information (B12.3)			
	All post-tender information for this section will be determined once tender is awarded			
		Fixed		Item
		Value Related		Item
		Time Related		Item
	<u>SECTION C: SPECIFIC PRELIMINARIES</u>			
	Section C contains specific preliminary items which apply to this contract except where N/A (Not Applicable) appears against an item			
	Carried to Collection			R
	Section No. 1 Bill No 1 - Preliminaries LDPW-B/20151 - BILLS OF QUANTITIES			

**CONSTRUCTION OF NEW LIBRARY
INCLUDING ELECTRICAL, MECHANICAL INSTALLATION
AND ASSOCIATED EXTERNAL WORKS
AT VLEIFONTEIN, VHEMBE DISTRICT**

104	<p>Clause C1 - Contract drawings</p> <p>The drawings issued with the tender documents do not comprise the complete set but serve as a guide only for tendering purposes and for indicating the scope of the work to enable the tenderer to acquaint himself with the nature and extent of the works and the manner in which they are to be executed</p> <p>Should any part of the drawings not be clearly understood by the tenderer he shall, before submitting his tender, obtain clarification in writing from the principal agent</p>			
	Fixed			Item
	Value Related			Item
	Time Related			Item
105	<p>Clause C2 - General Preambles</p> <p>The "Model Preambles for Trades (2008 Edition)" and Supplementary preambles as specified in the trades is deemed to be included herein and shall be read in conjunction with the bills of quantities and be referred to for the full descriptions of work to be done and materials to be used.</p>			
	Fixed			Item
	Value Related			Item
	Time Related			Item
	Carried to Collection			R
	Section No. 1 Bill No 1 - Preliminaries LDPW-B/20151 - BILLS OF QUANTITIES			

**CONSTRUCTION OF NEW LIBRARY
INCLUDING ELECTRICAL, MECHANICAL INSTALLATION
AND ASSOCIATED EXTERNAL WORKS
AT VLEIFONTEIN, VHEMBE DISTRICT**

106 **Clause C3 - Site instructions**

All site instructions issued on site shall be recorded in writing within seven (7) calendar days in site instruction book (A4 size and triplicate carbon format), which is to be provided and maintained by the contractor. The said site instruction book shall be kept on site at all times for the exclusive use of recording site instructions only

Site instructions may be issued by the architect or any of the consultants only. Copies of the site instructions are to be submitted to the architect and quantity surveyor within seven (7) calendar days of such recording in the site instruction book

Fixed

Item

Value Related

Item

Time Related

Item

107 **Clause C4 - Trade Names**

Wherever a trade name for any product has been described in the **bills of quantities**, the tenderer's attention is drawn to the fact that any other product of equal quality may be used subject to the written approval of the **principal agent** being obtained prior to the closing date for submission of tenders

If prior written approval for an alternative product is not obtained, the product described shall be deemed to have been tendered for

Fixed

Item

Value Related

Item

Time Related

Item

Carried to Collection

R

Section No. 1
Bill No 1 - Preliminaries
LDPW-B/20151 - BILLS OF QUANTITIES

**CONSTRUCTION OF NEW LIBRARY
INCLUDING ELECTRICAL, MECHANICAL INSTALLATION
AND ASSOCIATED EXTERNAL WORKS
AT VLEIFONTEIN, VHEMBE DISTRICT**

108

Clause C5 - Overtime

Should overtime be required to be worked for any reason whatsoever, the costs of such overtime are to be borne by the contractor unless the principal agent has specifically authorized and indicated in writing, prior to the execution thereof, that costs for such overtime will to be borne by the employer

Fixed

Item

Value Related

Item

Time Related

Item

Carried to Collection

R

Section No. 1
Bill No 1 - Preliminaries
LDPW-B/20151 - BILLS OF QUANTITIES

**CONSTRUCTION OF NEW LIBRARY
INCLUDING ELECTRICAL, MECHANICAL INSTALLATION
AND ASSOCIATED EXTERNAL WORKS
AT VLEIFONTEIN, VHEMBE DISTRICT**

109 **Clause C6 - As-built drawings**

The position of construction breaks and the extent of individual concrete pours are to be recorded by the contractor on the structural engineer's drawings and are to be submitted to the principal agent and the structural engineer for their records

Fixed

Item

Value Related

Item

Time Related

Item

110 **Clause C5 - Labour record**

At the end of each week the contractor shall provide the principal agent with a written record, in schedule form, reflecting the number and description of tradesmen and labourers employed by him and all subcontractors on the works each day

Labourers on site should have been properly appointed by the contractor and an **appointment letter signed by both parties, Certified ID copies, Signed Payment Register** should accompany Progress Payment Certificate each month. **EPWP Data Tool Form** must be signed by both the Community Liaising Officer (CLO) and Project Manager before submission for payment.

Fixed

Item

Value Related

Item

Time Related

Item

Carried to Collection

R

Section No. 1
Bill No 1 - Preliminaries
LDPW-B/20151 - BILLS OF QUANTITIES

**CONSTRUCTION OF NEW LIBRARY
INCLUDING ELECTRICAL, MECHANICAL INSTALLATION
AND ASSOCIATED EXTERNAL WORKS
AT VLEIFONTEIN, VHEMBE DISTRICT**

111 **Clause C6 - Plant record**

At the end of each calendar week the contractor shall provide the principal agent with a written record, in schedule form, reflecting the number, type and capacity of all plant, excluding hand tools, currently used on the works

Fixed

Item

Value Related

Item

Time Related

Item

112 **Clause C7 - Non-cession of monies**

The contractor shall not cede nor assign his rights or claims to any monies due or to become due to him under this contract

Fixed

Item

Value Related

Item

Time Related

Item

Carried to Collection

R

Section No. 1
Bill No 1 - Preliminaries
LDPW-B/20151 - BILLS OF QUANTITIES

**CONSTRUCTION OF NEW LIBRARY
INCLUDING ELECTRICAL, MECHANICAL INSTALLATION
AND ASSOCIATED EXTERNAL WORKS
AT VLEIFONTEIN, VHEMBE DISTRICT**

113 **Clause C8 - Occupational Health and Safety Act**

The **contractor** shall comply with all the requirements set out in the Construction Regulations, 2003 issued under the Occupational Health and Safety Act, 1993 (Act No 85 of 1993).

It is required of the **contractor** to thoroughly study the **latest** Health and Safety Specification that must be read together with and is deemed to be incorporated under this Section of the **bills of quantities / lump sum document**.

The **contractor** must take note that compliance with the Occupational Health and Safety Act, Construction Regulations and Health and Safety Specification is compulsory. In the event of partial or total non-compliance, the **principal agent**, notwithstanding the provisions of clause A31.0 of Section A or any other clause to the contrary, reserves the right to delay issuing any progress **payment certificate** until the **contractor** provides satisfactory proof of compliance. The **contractor** shall not be entitled to any compensation of whatsoever nature, including interest, due to such delay of payment.

Provision for pricing of the Occupational Health and Safety Act, Construction Regulations and Health and Safety Specification is made under this clause and it is explicitly pointed out that all requirements of the aforementioned are deemed to be priced hereunder and no additional claims in this regard shall be entertained.

Fixed

Item

Value Related

Item

Time Related

Item

Carried to Collection

R

Section No. 1
Bill No 1 - Preliminaries
LDPW-B/20151 - BILLS OF QUANTITIES

**CONSTRUCTION OF NEW LIBRARY
INCLUDING ELECTRICAL, MECHANICAL INSTALLATION
AND ASSOCIATED EXTERNAL WORKS
AT VLEIFONTEIN, VHEMBE DISTRICT**

114	<p>Clause C9 - Viewing of the Schoemansdal Museum areas</p> <p>The site is situated in a Schoemansdal Museum area and the tenderer must arrange with the Principal or other responsible Schoemansdal Museum staff to obtain permission to enter the site for tendering purposes</p>			
	Fixed		Item	
	Value Related		Item	
	Time Related		Item	
115	<p>Clause C10 - Commencement of Works in Museum Areas</p> <p>As the works falls within a museum area the contractor must give the Principal or other responsible staff member notice before commencement of the works. Should the contractor fail to make such arrangements, admission to the site may be refused and any additional costs will be for the contractor's account</p>			
	Fixed		Item	
	Value Related		Item	
	Time Related		Item	
	Carried to Collection			R
	Section No. 1			
	Bill No 1 - Preliminaries			
	LDPW-B/20151 - BILLS OF QUANTITIES			

**CONSTRUCTION OF NEW LIBRARY
INCLUDING ELECTRICAL, MECHANICAL INSTALLATION
AND ASSOCIATED EXTERNAL WORKS
AT VLEIFONTEIN, VHEMBE DISTRICT**

116 **Clause C11 - Entrance Permits to Schoemansdal Museum Areas**

As the **works** falls within a museum area the **contractor** shall obtain entrance permits for his personnel and workmen entering the area and shall comply with all regulations and instructions which may be issued from time to time regarding the protection of persons and property under the control of the Principal, or chief security officer

Fixed

Item

Value Related

Item

Time Related

Item

117 **Clause C12 - Security Check of Personnel**

The **principal agent** may require the **contractor** to have his personnel and workmen, or a certain number of them, security classified

In the event of the **principal agent** requesting the removal of a person or persons from the **works** for security reasons, the **contractor** shall do so forthwith and shall thereafter ensure that such person or persons are denied access to the **works** and the **site** and/or to any document or information relating to the **works**

Fixed

Item

Value Related

Item

Time Related

Item

Carried to Collection

R

Section No. 1
Bill No 1 - Preliminaries
LDPW-B/20151 - BILLS OF QUANTITIES

**CONSTRUCTION OF NEW LIBRARY
INCLUDING ELECTRICAL, MECHANICAL INSTALLATION
AND ASSOCIATED EXTERNAL WORKS
AT VLEIFONTEIN, VHEMBE DISTRICT**

118 **Clause C13 - HIV/Aids Awareness**

It is required of the **contractor** to thoroughly study the HIV/AIDS Specification (PW 1544) of the Department that must be read together with and is deemed to be incorporated under this Section of the **bills of quantities**. Provision for pricing of HIV/AIDS awareness is made under items C10.1 to C10.5 hereafter and it is explicitly pointed out that all requirements of the aforementioned specification are deemed to be priced hereunder, as the said items represent the only method of measurement and no additional items or extras to the contract in this regard shall be entertained

The **contractor** must take note that compliance with the HIV/AIDS Specification is compulsory. In the event of partial or total non-compliance, the **principal agent**, notwithstanding the provisions of Clause A 31.0 of Section A or any other clause to the contrary, reserves the right to delay issuing any progress **payment certificate** until the **contractor** provides satisfactory proof of compliance. The **contractor** shall not be entitled to any compensation of whatsoever nature, including interest, due to such delay of payment

Fixed

Item

Value Related

Item

Time Related

Item

119 **Clause C13.1 - Awareness Champion**

Selection, appointment, briefing and making available of an Awareness Champion including provision of all relevant services, all in accordance with the HIV/AIDS Specification

Fixed

Item

Value Related

Item

Time Related

Item

Carried to Collection

R

Section No. 1
Bill No 1 - Preliminaries
LDPW-B/20151 - BILLS OF QUANTITIES

**CONSTRUCTION OF NEW LIBRARY
INCLUDING ELECTRICAL, MECHANICAL INSTALLATION
AND ASSOCIATED EXTERNAL WORKS
AT VLEIFONTEIN, VHEMBE DISTRICT**

120	<p>Clause C13.2 - Awareness Workshop</p> <p>Selection and appointment of a competent Service Provider approved by the principal agent, provision of a Service Provider Workshop Plan and a suitable venue, conducting of awareness workshops by means of traditional and/or modern multi-media techniques, including follow-up courses, making available all tuition material and performing assessment procedures, all in accordance with the HIV/AIDS Specification</p>			
	Fixed			Item
	Value Related			Item
	Time Related			Item
121	<p>Clause C13.3 - Posters, booklets, videos, etc.</p> <p>Provision, displaying, maintaining and replacing when necessary of four plastic laminated posters, booklets and educational videos, etc. for the duration of the construction period, all in accordance with the HIV/AIDS Specification</p>			
	Fixed			Item
	Value Related			Item
	Time Related			Item
	Carried to Collection			R
	Section No. 1			
	Bill No 1 - Preliminaries			
	LDPW-B/20151 - BILLS OF QUANTITIES			

**CONSTRUCTION OF NEW LIBRARY
INCLUDING ELECTRICAL, MECHANICAL INSTALLATION
AND ASSOCIATED EXTERNAL WORKS
AT VLEIFONTEIN, VHEMBE DISTRICT**

122	<p>Clause C13.4 - Access to Condoms</p> <p>Provision and maintenance of condom dispensers fixed in position, including male and female condoms, replenishing male and female condoms on a daily basis as required for the duration of the construction period, all in accordance with the HIV/AIDS Specification</p>			
	Fixed		Item	
	Value Related		Item	
	Time Related		Item	
123	<p>Clause C13.5- Monitoring</p> <p>Monitoring HIV/AIDS awareness of workers, providing the principal agent with access to information including making available all reports, thoroughly completed and reflecting the correct information, for the duration of the construction period and close out, all in accordance with the HIV/AIDS Specification</p>			
	Fixed		Item	
	Value Related		Item	
	Time Related		Item	
124	<p>Clause C13.6- Contractual Price Adjustment (CPAP)</p> <p>Contractual Price Adjustment (CPAP)</p>			
	Fixed		Item	
	Value Related		Item	
	Time Related		Item	
	Carried to Collection			R
	Section No. 1			
	Bill No 1 - Preliminaries			
	LDPW-B/20151 - BILLS OF QUANTITIES			

**CONSTRUCTION OF NEW LIBRARY
INCLUDING ELECTRICAL, MECHANICAL INSTALLATION
AND ASSOCIATED EXTERNAL WORKS
AT VLEIFONTEIN, VHEMBE DISTRICT**

PROVISIONS

Provision for Community Liaison Officer (CLO)

125	Provision for Community Liaison Officer (CLO)		Item
	Profit and Overheads		Item

Provision for Training Allowance in terms of EPWP prescripts

126	Provision for Training of local labour		Item
	Profit and Overheads		Item
127	Training Allowance paid to targeted labour in terms of formal training days	MAN-D	600
	Extra over for the administration payment of training allowance to targeted labour.		Item

Carried to Collection

R

Section No. 1
Bill No 1 - Preliminaries

**CONSTRUCTION OF NEW LIBRARY
INCLUDING ELECTRICAL, MECHANICAL INSTALLATION
AND ASSOCIATED EXTERNAL WORKS
AT VLEIFONTEIN, VHEMBE DISTRICT**

Section No. 1

Bill No. 1

Bill No 1 - Preliminaries

COLLECTION

Total Brought Forward from Page No.

**Page
No**

118

Amount

Total Brought Forward from Page No.

119

Total Brought Forward from Page No.

120

Total Brought Forward from Page No.

121

Total Brought Forward from Page No.

122

Total Brought Forward from Page No.

123

Total Brought Forward from Page No.

124

Total Brought Forward from Page No.

125

Total Brought Forward from Page No.

126

Total Brought Forward from Page No.

127

Total Brought Forward from Page No.

128

Total Brought Forward from Page No.

129

Total Brought Forward from Page No.

130

Total Brought Forward from Page No.

131

Total Brought Forward from Page No.

132

Total Brought Forward from Page No.

133

Total Brought Forward from Page No.

134

Total Brought Forward from Page No.

135

Carried Forward

R

Section No. 1

Bill No 1 - Preliminaries

LDPW-B/20151 - BILLS OF QUANTITIES

**CONSTRUCTION OF NEW LIBRARY
INCLUDING ELECTRICAL, MECHANICAL INSTALLATION
AND ASSOCIATED EXTERNAL WORKS
AT VLEIFONTEIN, VHEMBE DISTRICT**

Section No. 1

Bill No. 1

Bill No 1 - Preliminaries

COLLECTION

	Page No	Amount
Brought Forward		R
Total Brought Forward from Page No.	136	
Total Brought Forward from Page No.	137	
Total Brought Forward from Page No.	138	
Total Brought Forward from Page No.	139	
Total Brought Forward from Page No.	140	
Total Brought Forward from Page No.	141	
Total Brought Forward from Page No.	142	
Total Brought Forward from Page No.	143	
Total Brought Forward from Page No.	144	
Total Brought Forward from Page No.	145	
Total Brought Forward from Page No.	146	
Total Brought Forward from Page No.	147	
Total Brought Forward from Page No.	148	
Total Brought Forward from Page No.	149	
Total Brought Forward from Page No.	150	
Total Brought Forward from Page No.	151	
Total Brought Forward from Page No.	152	
Carried Forward		R

Section No. 1

Bill No 1 - Preliminaries

LDPW-B/20151 - BILLS OF QUANTITIES

**CONSTRUCTION OF NEW LIBRARY
INCLUDING ELECTRICAL, MECHANICAL INSTALLATION
AND ASSOCIATED EXTERNAL WORKS
AT VLEIFONTEIN, VHEMBE DISTRICT**

Section No. 1

Bill No. 1

Bill No 1 - Preliminaries

COLLECTION

	Page No	Amount
Brought Forward		R
Total Brought Forward from Page No.	153	
Total Brought Forward from Page No.	154	
Total Brought Forward from Page No.	155	
Total Brought Forward from Page No.	156	
Total Brought Forward from Page No.	157	
Total Brought Forward from Page No.	158	
Total Brought Forward from Page No.	159	
Total Brought Forward from Page No.	160	
Total Brought Forward from Page No.	161	
Total Brought Forward from Page No.	162	
Total Brought Forward from Page No.	163	
Total Brought Forward from Page No.	164	
Total Brought Forward from Page No.	165	
Total Brought Forward from Page No.	166	
Total Brought Forward from Page No.	167	
Total Brought Forward from Page No.	168	
Total Brought Forward from Page No.	169	
Carried Forward		R

Section No. 1

Bill No 1 - Preliminaries

LDPW-B/20151 - BILLS OF QUANTITIES

**CONSTRUCTION OF NEW LIBRARY
INCLUDING ELECTRICAL, MECHANICAL INSTALLATION
AND ASSOCIATED EXTERNAL WORKS
AT VLEIFONTEIN, VHEMBE DISTRICT**

Section No. 1

Bill No. 1

Bill No 1 - Preliminaries

COLLECTION

	Page No	Amount
Brought Forward		R
Total Brought Forward from Page No.	170	
Total Brought Forward from Page No.	171	
Total Brought Forward from Page No.	172	
Total Brought Forward from Page No.	173	
Total Brought Forward from Page No.	174	
Total Brought Forward from Page No.	175	
Total Brought Forward from Page No.	176	
Total Brought Forward from Page No.	177	
Total Brought Forward from Page No.	178	
Total Brought Forward from Page No.	179	
Total Brought Forward from Page No.	180	
Carried to Final Summary		R

Section No. 1

Bill No 1 - Preliminaries

LDPW-B/20151 - BILLS OF QUANTITIES

**CONSTRUCTION OF NEW LIBRARY
INCLUDING ELECTRICAL, MECHANICAL INSTALLATION
AND ASSOCIATED EXTERNAL WORKS
AT VLEIFONTEIN, VHEMBE DISTRICT**

Item No		Quantity	Rate	Amount
	<p><u>BILL NO. 2</u></p> <p><u>EARTHWORKS (PROVISIONAL)</u></p> <p><u>(WORK GROUP 104)</u></p> <p>PREAMBLES For preambles refer to "Department of Public Works: Specification of Materials and Method to be used - PW371"</p>			
	<p><u>NOTE</u></p> <p>All prices/rates to be net, excluding Value Added Tax</p> <p><u>SUPPLEMENTARY PREAMBLES</u></p> <p><u>Filling material (General)</u></p> <p>It will be, at all times, required from the Contractor to apply and execute strict quality control on all filling material used</p> <p>Samples of potential fill materials obtained from excavations, trench excavations, etc. are to be submitted to and approved by the Engineer prior the re-use thereof as "filling"</p> <p>All filling obtained from a commercial source should comply to a minimum G6 standard and to be approved by Engineer before haulage to site.</p> <p>Should any material be found unsuitable and the use thereof be disapproved, such material shall be disposed and approved material must be sourced and imported.</p> <p>Filling in general shall be compacted to the prescribed percentage Mod AASHTO density</p>			
	Carried to Collection			R
	<p>Section No. 2 Bill No 1 - Earthworks LDPW-B/20151 - BILLS OF QUANTITIES</p>			

**CONSTRUCTION OF NEW LIBRARY
INCLUDING ELECTRICAL, MECHANICAL INSTALLATION
AND ASSOCIATED EXTERNAL WORKS
AT VLEIFONTEIN, VHEMBE DISTRICT**

Filling to form earth mattresses, in sub-layers, under floors, etc

All filling in layers under surface beds, in sub-layers, to form earth mattresses, etc. shall be done with materials specified and according to methods prescribed by the SABS 1200ME Sub-base Specification.

The aforesaid specification was drawn up to cover activities normally encountered on civil engineering work, which is equally applicable on the filling details and requirements prescribed for this project

The said specification, although not issued with, shall be regarded to form part of these Bills of Quantities. The Contractor shall obtain a copy of the said specification from the South African Bureau of Standards and be kept on site at all times

CBR and Indicator tests

Density tests for monitoring filling shall be done at the minimum prescribed frequencies per each 150mm thick layer of filling placed.

The Contractor is to note that all necessary tests (i.e CBR and indicator tests, etc) are to be conducted for all filling material, whether obtained from the excavations or to be imported from an approved commercial source.

Results of these tests are to be submitted to and approved by Engineer prior commencement of any placement thereof and/or filling done therewith

Carried to Collection

Section No. 2
Bill No 1 - Earthworks
LDPW-B/20151 - BILLS OF QUANTITIES

R

**CONSTRUCTION OF NEW LIBRARY
INCLUDING ELECTRICAL, MECHANICAL INSTALLATION
AND ASSOCIATED EXTERNAL WORKS
AT VLEIFONTEIN, VHEMBE DISTRICT**

Density test

It will be required from the Contractor to execute density tests for monitoring filling at the following minimum frequencies per each filling layer placed:

- Filling under surface beds

1 Test per 25m² plan area per each 150mm thick layer

- Filling behind retaining walls:

1 Test per each 10m length of retaining wall

Results of density test executed are to be submitted to and approval obtained from the Engineer prior commencement of any subsequent fill layers and/or other work

Carried to Collection

R

Section No. 2
Bill No 1 - Earthworks
LDPW-B/20151 - BILLS OF QUANTITIES

**CONSTRUCTION OF NEW LIBRARY
INCLUDING ELECTRICAL, MECHANICAL INSTALLATION
AND ASSOCIATED EXTERNAL WORKS
AT VLEIFONTEIN, VHEMBE DISTRICT**

Carting away of excessive and/or unsuitable excavated material

Descriptions for "carting away excessive or unsuitable excavated material from site" shall be deemed to include the loading and hauling of excessive or unsuitable excavated material to a suitable dumping site, which has to be located by the Contractor, off the hospital premises

The location of the intended dumping site will be subjected to the prior written approval of the local authority (Municipality)

All materials for excavations marked for caring away shall be cart at Municipal designated dumping site and proof of dumping to be submitted to the Safety / Enviromental officer

The contractor will also be liable to remove upon completion, rehabilitate all those areas of the dumping site used for dumping/spoiling by grading the area to follow the adjacent ground contours and afterwards compacted to 80% Mod AASHTO density, all to the full satisfaction of the Engineer/Principal Agent

Tendered rates must make provision for the above-mentioned as no additional claims in this regard will afterwards be entertained

NOTE: All materials from excavations marked from carting away shall be cart at Municipal designated dumping site and proof of dumping to be submitted to the Safety / Enviromental officer

Carried to Collection

Section No. 2
Bill No 1 - Earthworks

LDPW-B/20151 - BILLS OF QUANTITIES

R

**CONSTRUCTION OF NEW LIBRARY
INCLUDING ELECTRICAL, MECHANICAL INSTALLATION
AND ASSOCIATED EXTERNAL WORKS
AT VLEIFONTEIN, VHEMBE DISTRICT**

EXCAVATIONS, FILLING, ETC.

**Excavate in earth below natural ground level,
reduced or made up ground level, not exceeding 2m
deep, for:**

1	Trenches	m3	165
2	Holes	m3	4

**Extra over trench and hole excavations in earth for
excavation for**

3	Working space not exceeding 500mm deep	m2	608
4	Working space exceeding 500mm and not exceeding 1500mm deep	m2	140

**Extra over trench and hole excavations in earth for
excavation in**

5	Soft rock	m3	15
6	Hard rock	m3	7

Extra over all excavations for carting away

7	Surplus or unwanted excavated material to stock piles on site or to a dumping site to be located by the contractor	m3	130
---	--	----	-----

Risk of collapse of excavations

8	Sides of trench excavations not exceeding 1,5m deep	m2	786
9	Sides of hole excavations not exceeding 1,5m deep	m2	11

Keeping excavations free of water

10	Allow for bailing, pumping or otherwise keeping all excavations free from water		Item
----	--	--	------

Carried to Collection

R

Section No. 2
Bill No 1 - Earthworks

**CONSTRUCTION OF NEW LIBRARY
INCLUDING ELECTRICAL, MECHANICAL INSTALLATION
AND ASSOCIATED EXTERNAL WORKS
AT VLEIFONTEIN, VHEMBE DISTRICT**

LDPW-B/20151 - BILLS OF QUANTITIES

--	--	--	--	--

**CONSTRUCTION OF NEW LIBRARY
INCLUDING ELECTRICAL, MECHANICAL INSTALLATION
AND ASSOCIATED EXTERNAL WORKS
AT VLEIFONTEIN, VHEMBE DISTRICT**

**Earth filling obtained from the excavations
compacted to 93% Mod AASHTO density**

11	In backfilling to trenches, holes, etc	m3	47
12	Under floors, steps, pavings, etc	m3	95

**Approved earth filling supplied by the contractor,
spread, levelled, watered, and compacted to 95%
Mod AASHTO density in layers not exceeding
150mm thick (Rate/m3 shall be for compacted
material and not loose material)**

13	Under floors, steps, pavings, etc	m3	18
14	Under floors to form ramps	m3	7

Sand bed

15	50mm Thick dry, clean, washed riversand layer evenly spread over filling (elsewhere), levelled, watered and rammed to receive waterproofing membrane (elsewhere) under solid floors	m2	883
----	---	----	-----

Compaction of surfaces

16	Compaction of ground surface under floors etc including scarifying for a depth of 150mm, breaking down oversize material, adding suitable material where necessary and compacting to 95% Mod AASHTO density	m2	883
----	---	----	-----

Prescribed density tests on filling (no payment for compaction shall be allowed until compaction results are produced, only results which have passed the test shall be paid for)

17	Modified AASHTO Density test	No	44
----	------------------------------	----	----

Carried to Collection

R

***CONSTRUCTION OF NEW LIBRARY
INCLUDING ELECTRICAL, MECHANICAL INSTALLATION
AND ASSOCIATED EXTERNAL WORKS
AT VLEIFONTEIN, VHEMBE DISTRICT***

LDPW-B/20151 - BILLS OF QUANTITIES

--	--	--	--	--

**CONSTRUCTION OF NEW LIBRARY
INCLUDING ELECTRICAL, MECHANICAL INSTALLATION
AND ASSOCIATED EXTERNAL WORKS
AT VLEIFONTEIN, VHEMBE DISTRICT**

SOIL POISONING

Approved insecticide solutions shall be mixed on site in the presence of clerk of works/engineer/principal agent in strict accordance with the manufacturers/suppliers specifications

Soil insecticide under a 5 year guarantee by an approved firm of registered specialists

18	To bottom and sides of trenches, holes etc	m2	1 083
19	Under floors etc including forming and poisoning shallow furrows against foundation walls etc, filling in furrows and ramming	m2	883
<u>Weedkiller, "Hyvar X' or other approved by a firm of specialist</u>			
20	Under aprons,paving etc	m2	400

Carried to Collection

R

Section No. 2
Bill No 1 - Earthworks

LDPW-B/20151 - BILLS OF QUANTITIES

**CONSTRUCTION OF NEW LIBRARY
INCLUDING ELECTRICAL, MECHANICAL INSTALLATION
AND ASSOCIATED EXTERNAL WORKS
AT VLEIFONTEIN, VHEMBE DISTRICT**

Section No. 2

Bill No. 1

Bill No 1 - Earthworks

COLLECTION

Total Brought Forward from Page No.

**Page
No**

185

Amount

Total Brought Forward from Page No.

186

Total Brought Forward from Page No.

187

Total Brought Forward from Page No.

188

Total Brought Forward from Page No.

189

Total Brought Forward from Page No.

190

Total Brought Forward from Page No.

191

Carried Forward to Summary of Section No. 2

R

Section No. 2

Bill No 1 - Earthworks

LDPW-B/20151 - BILLS OF QUANTITIES

**CONSTRUCTION OF NEW LIBRARY
INCLUDING ELECTRICAL, MECHANICAL INSTALLATION
AND ASSOCIATED EXTERNAL WORKS
AT VLEIFONTEIN, VHEMBE DISTRICT**

Item No		Quantity	Rate	Amount
	<p><u>BILL NO. 3</u></p> <p><u>CONCRETE, FORMWORK AND REINFORCEMENT</u></p> <p><u>(WORK GROUP 110)</u></p> <p><u>PREAMBLES</u>For preambles refer to <u>"Department of Public Works: Specification of Materials and Method to be used - PW371"</u></p> <p><u>NOTE</u></p> <p>All prices/rates to be net, excluding Value Added Tax</p>			
	Carried to Collection			R
	<p>Section No. 2</p> <p>Bill No 2 - Concrete, formwork and reinforcement</p> <p>LDPW-B/20151 - BILLS OF QUANTITIES</p>			

**CONSTRUCTION OF NEW LIBRARY
INCLUDING ELECTRICAL, MECHANICAL INSTALLATION
AND ASSOCIATED EXTERNAL WORKS
AT VLEIFONTEIN, VHEMBE DISTRICT**

SUPPLEMENTARY PREAMBLES

Concrete test cubes

Descriptions and tendered rates for concrete strength test cubes, as required under clause 7, "Tests" of SABS 1200 G, shall be deemed to cater for all the cost of providing cube moulds necessary for the purpose, making, storing and sending thereof to an approved laboratory for testing, paying all charges in connection therewith and for submitting test results to Principal Agent

All concrete strength test cubes, each 150 x 150 x 150mm shall be prepared in a set of three

It will be required from the contractor to prepare concrete strength test cube sets for each section (radiology, dental etc) at the following minimum frequencies:

- One set of three cubes for every 20m³,
or part thereof, of concrete cast per day,

or

- One set of three cubes for each batch
of concrete cast per event as directed
by the Clerk Of Works.

All concrete strength test cubes shall be done on site regardless of ready mix and shall be labelled and the identity thereof (ie. date, concrete strength type, position where batch was cast relative to the area and section identity) shall be properly recorded for future reference.

Carried to Collection

Section No. 2
Bill No 2 - Concrete, formwork and reinforcement
LDPW-B/20151 - BILLS OF QUANTITIES

R

**CONSTRUCTION OF NEW LIBRARY
INCLUDING ELECTRICAL, MECHANICAL INSTALLATION
AND ASSOCIATED EXTERNAL WORKS
AT VLEIFONTEIN, VHEMBE DISTRICT**

Formwork

Descriptions of formwork shall be deemed to include use and waste only (except where described as "left in" or "permanent") for fitting together in the required forms, wedging, plumbing and fixing to true angles and surfaces as necessary to ensure easy release during stripping and reconditioning as necessary before re-use

The vertical strutting shall be carried down to such construction as is sufficiently strong to afford the required support without damage and shall remain in position until the newly constructed work is able to support itself

Formwork to sides of bases, pile caps, ground beams, etc. will only be measured where it is prescribed by the Principal Agent for design reasons. Formwork necessitated by irregularities or collapse of excavated faces will not be measured and the cost thereof shall be deemed to be included in the allowance for taking the risk of collapse of the sides of the excavations, provision which is made for in "Earthworks"

Carried to Collection

Section No. 2
Bill No 2 - Concrete, formwork and reinforcement
LDPW-B/20151 - BILLS OF QUANTITIES

R

**CONSTRUCTION OF NEW LIBRARY
INCLUDING ELECTRICAL, MECHANICAL INSTALLATION
AND ASSOCIATED EXTERNAL WORKS
AT VLEIFONTEIN, VHEMBE DISTRICT**

Test Blocks (Provisional)

1	Making of 150 x 150 x 150mm concrete strength test cube in sets of three, label and send to an approved laboratory for testing, including paying all charges and submit report to the Principal agent. (only successful tests will be paid for)	Sets	29	
---	---	------	----	--

MASS CONCRETE

CONCRETE

Unreinforced concrete cast against excavated surfaces

Reinforced concrete with a coarse aggregate of 19mm and a minimum compressive strength of 15MPa at 28 days

2	Surface blinding under strip footing and column bases	m3	12	
3	In aprons cast in panels	m3	23	
4	In channels	m3	15	

REINFORCED CONCRETE

Reinforced concrete with a coarse aggregate of 19mm and a minimum compressive strength of 30MPa at 28 days

5	In strip footings against excavated surfaces	m3	33	
6	In bases against excavated surfaces	m3	1	
7	In surface beds cast in bays over waterproofing membrane (elsewhere)	m3	89	
8	In ramps	m3	7	
9	Ground Beams	m3	70	

Carried to Collection

R

Section No. 2
Bill No 2 - Concrete, formwork and reinforcement
LDPW-B/20151 - BILLS OF QUANTITIES

**CONSTRUCTION OF NEW LIBRARY
INCLUDING ELECTRICAL, MECHANICAL INSTALLATION
AND ASSOCIATED EXTERNAL WORKS
AT VLEIFONTEIN, VHEMBE DISTRICT**

10	Beams and inverted beams	m3	18
11	Columns	m3	1
12	Stub columns	m3	0.2
<u>SUNDRIES</u>			
<u>Finishing surfaces of concrete smooth with a woodfloat</u>			
13	Surface beds, slabs, etc	m2	883
14	Aprons, slabs, etc	m2	225
<u>Finishing top surfaces of concrete to form anti-skid finish</u>			
15	Ramp, etc	m2	16

Carried to Collection

R

Section No. 2
Bill No 2 - Concrete, formwork and reinforcement
LDPW-B/20151 - BILLS OF QUANTITIES

**CONSTRUCTION OF NEW LIBRARY
INCLUDING ELECTRICAL, MECHANICAL INSTALLATION
AND ASSOCIATED EXTERNAL WORKS
AT VLEIFONTEIN, VHEMBE DISTRICT**

FORMWORK

(WORK GROUP 111)

ROUGH FORMWORK (DEGREE OF ACCURACY III)

Rough formwork to

16	Sides of beams and inverted beams	m2	188
17	Sides of columns	m2	11
18	Ditto but in foundations	m2	656
19	Ditto, but stub columns in foundations	m2	3
20	Edges, risers, ends and reveals not exceeding 300mm high or wide	m	150
21	25 x 25mm Chamfers along top/bottom of beam	m	1 193
22	110mm Diameter to form hole for cable sleeves	No	14
23	160mm Diameter to form hole for cable sleeves	No	3

SMOOTH FORMWORK (DEGREE OF ACCURACY III)

Sundries

24	300mm Hoop iron anchors shot pinned to concrete and built into brickwork	No	50
----	--	----	----

Carried to Collection

R

Section No. 2
Bill No 2 - Concrete, formwork and reinforcement
LDPW-B/20151 - BILLS OF QUANTITIES

**CONSTRUCTION OF NEW LIBRARY
INCLUDING ELECTRICAL, MECHANICAL INSTALLATION
AND ASSOCIATED EXTERNAL WORKS
AT VLEIFONTEIN, VHEMBE DISTRICT**

MOVEMENT JOINTS ETC

Movement joints

25	Movement joint formed of 15mm bitumen impregnated softboard not exceeding 300mm high built in vertically between brickwork and concrete and sealed with polysulphide sealing compound externally	m	37
----	--	---	----

Expansion joints

26	Movement joint not exceeding 300mm high formed of 20mm polystyrene placed vertically in position between concrete surfaces including approved sealant	m	160
----	---	---	-----

Saw cut joints including polysulphide sealing compound

27	6 x 10mm Saw cut joints in top of concrete	m	274
----	--	---	-----

Carried to Collection

R

Section No. 2
Bill No 2 - Concrete, formwork and reinforcement
LDPW-B/20151 - BILLS OF QUANTITIES

**CONSTRUCTION OF NEW LIBRARY
INCLUDING ELECTRICAL, MECHANICAL INSTALLATION
AND ASSOCIATED EXTERNAL WORKS
AT VLEIFONTEIN, VHEMBE DISTRICT**

REINFORCEMENT (PROVISIONAL)

(WORK GROUP 114)

Mild steel reinforcement to structural concrete work

28	R20 Mild steel rod reinforcement	t	0.43	
----	----------------------------------	---	------	--

High tensile steel reinforcement to structural concrete work

29	Y10 High tensile steel rod reinforcement	t	1.79	
----	--	---	------	--

30	Y12 High tensile steel rod reinforcement	t	2.18	
----	--	---	------	--

31	Y16 High tensile steel rod reinforcement	t	0.31	
----	--	---	------	--

32	Y20 High tensile steel rod reinforcement	t	0.30	
----	--	---	------	--

33	High tensile Y16 steel rod 700mm long dowels at 1000mm centres in construction joints	No	18	
----	---	----	----	--

Fabric reinforcement

34	Type Ref 193 fabric reinforcement in concrete surface beds, slabs, etc	m2	883	
----	--	----	-----	--

Carried to Collection

R

Section No. 2
Bill No 2 - Concrete, formwork and reinforcement
LDPW-B/20151 - BILLS OF QUANTITIES

**CONSTRUCTION OF NEW LIBRARY
INCLUDING ELECTRICAL, MECHANICAL INSTALLATION
AND ASSOCIATED EXTERNAL WORKS
AT VLEIFONTEIN, VHEMBE DISTRICT**

Section No. 2

Bill No. 2

Bill No 2 - Concrete, formwork and reinforcement

COLLECTION

Total Brought Forward from Page No.

**Page
No**

193

Amount

Total Brought Forward from Page No.

194

Total Brought Forward from Page No.

195

Total Brought Forward from Page No.

196

Total Brought Forward from Page No.

197

Total Brought Forward from Page No.

198

Total Brought Forward from Page No.

199

Total Brought Forward from Page No.

200

Carried Forward to Summary of Section No. 2

R

Section No. 2

Bill No 2 - Concrete, formwork and reinforcement

LDPW-B/20151 - BILLS OF QUANTITIES

**CONSTRUCTION OF NEW LIBRARY
INCLUDING ELECTRICAL, MECHANICAL INSTALLATION
AND ASSOCIATED EXTERNAL WORKS
AT VLEIFONTEIN, VHEMBE DISTRICT**

Item No		Quantity	Rate	Amount
	<u>BILL NO. 4</u>			
	<u>MASONRY</u>			
	<u>(WORK GROUP 118)</u>			
	<u>PREAMBLES</u> For preambles refer to <u>"Department of Public Works: Specification of Materials and Method to be used - PW371"</u>			
	<u>NOTE</u>			
	All prices/rates to be net, excluding Value Added Tax			
	<u>SUPPLEMENTARY PREAMBLES</u>			
	<u>Wall ties</u>			
	Descriptions and rates for cavity walls specified to include wire ties shall, unless otherwise specified, be deemed to include at least five metal wire ties, evenly spaced, per square metre brickwork. Metal wall ties shall:			
	- Comply with SABS 28 and of the butterfly or the modified PWD type			
	- Of suitable lengths to ensure that ends are built at least 75mm deep into brickwork.			
	Carried to Collection		R	
	Section No. 2 Bill No 3 - Masonry LDPW-B/20151 - BILLS OF QUANTITIES			

**CONSTRUCTION OF NEW LIBRARY
INCLUDING ELECTRICAL, MECHANICAL INSTALLATION
AND ASSOCIATED EXTERNAL WORKS
AT VLEIFONTEIN, VHEMBE DISTRICT**

Face bricks

Bricks shall be ordered timeously to obtain uniformity in size and colour. Contractor to verify size uniformity prior to laying

Pointing

Description of recessed pointing to fair face brickwork and face brickwork shall be deemed to include square recessed, hollow recessed, weathered pointing, etc

Carried to Collection

R

Section No. 2
Bill No 3 - Masonry
LDPW-B/20151 - BILLS OF QUANTITIES

**CONSTRUCTION OF NEW LIBRARY
INCLUDING ELECTRICAL, MECHANICAL INSTALLATION
AND ASSOCIATED EXTERNAL WORKS
AT VLEIFONTEIN, VHEMBE DISTRICT**

SUBSTRUCTURE (PROVISIONAL)

Brickwork

Brickwork of NFX bricks (14 MPa nominal compressive strength) in class I mortar in foundations

1	One brickwall	m2	109
2	One brickwall circular on plan	m2	1

SUPERSTRUCTURE

Brickwork of NFP bricks (7 MPa nominal compressive strength) in class II mortar

3	Half brick walls	m2	205
4	Half brick walls in beamfilling	m2	1
5	Half brick walls above plate level	m2	50
6	One brick walls	m2	987
7	One brick walls in fire walls	m2	40
8	One brick walls above plate level	m2	56
9	One brickwall circular on plan	m2	28
10	One brick yard walls	m2	306
11	One brickwall in gables	m2	67

Carried to Collection

R

Section No. 2
Bill No 3 - Masonry
LDPW-B/20151 - BILLS OF QUANTITIES

**CONSTRUCTION OF NEW LIBRARY
INCLUDING ELECTRICAL, MECHANICAL INSTALLATION
AND ASSOCIATED EXTERNAL WORKS
AT VLEIFONTEIN, VHEMBE DISTRICT**

SUNDRIES

Brick reinforcement in substructure (Provisional)

12	Brick reinforcement 150mm wide in foundation built into brick walls with sufficient laps at end joints, angles and intersections (measured net)	m	712
----	---	---	-----

Brick reinforcement in superstructure

13	Brick reinforcement 75mm wide built into brick walls with sufficient laps at end joints, angles and intersections (measured net)	m	191
14	Brick reinforcement 150mm wide built into brick walls with sufficient laps at end joints, angles and intersections (measured net)	m	892

Prestressed fabricated lintels

15	100mm x 70mm Lintel not exceeding 3m long, hoisted into position and laid over opening in brick wall with ends bedded in class II mortar	m	152
----	--	---	-----

Turning pieces

16	230mm Wide turning pieces to lintels etc	m	170
----	--	---	-----

Movement joints

17	Movement joint formed of 20mm polystyrene built in vertically between brickwork	m2	95
----	---	----	----

Closing cavities

18	Closing 50mm cavity of hollow wall one course high, horizontally with mortar in foundations (<u>Provisional</u>)	m	30
----	--	---	----

Hoop iron

19	25 x 1mm thick Galvanised hoop iron 300mm Long shot pinned to concrete beams and built into brick work	No	312
----	--	----	-----

Bill No 3 - Masonry

**CONSTRUCTION OF NEW LIBRARY
INCLUDING ELECTRICAL, MECHANICAL INSTALLATION
AND ASSOCIATED EXTERNAL WORKS
AT VLEIFONTEIN, VHEMBE DISTRICT**

Carried to Collection

R

LDPW-B/20151 - BILLS OF QUANTITIES

**CONSTRUCTION OF NEW LIBRARY
INCLUDING ELECTRICAL, MECHANICAL INSTALLATION
AND ASSOCIATED EXTERNAL WORKS
AT VLEIFONTEIN, VHEMBE DISTRICT**

FACE BRICKWORK

**Equal and approved facebricks to match existing
(PC R6500/1000 bricks including delivery to site but
excluding VAT) pointed with recessed horizontal
and vertical joints**

20	Extra over brickwork for facing and pointing in foundation (Provisional)	m2	55
21	Extra over brickwork for face brickwork	m2	373
22	Extra over brickwork for face brickwork in gables	m2	58
23	Extra over brickwork for face brickwork to dido	m2	325
24	Extra over brickwork for face brickwork curved on plan	m2	0.4
25	Extra over brickwork for brick-on-edge header course lintel pointed on face and 115mm soffit	m	118
<u>Brick-on-edge header course copings, sills, etc of face bricks pointed with recessed joints on all exposed faces</u>			
26	Coping on top of one brick wall	m	81
27	Coping on top of one brick wall curved on plan	m	1
28	175mm Wide sill set sloping and slightly projecting	m	97
29	Fair raking cutting	m	12
30	Fair circular cutting for pipes not exceeding 100mm diameter	No	7
31	Fair circular cutting for pipes exceeding 100mm and not exceeding 200mm diameter	No	14

Carried to Collection

R

Section No. 2
Bill No 3 - Masonry
LDPW-B/20151 - BILLS OF QUANTITIES

**CONSTRUCTION OF NEW LIBRARY
INCLUDING ELECTRICAL, MECHANICAL INSTALLATION
AND ASSOCIATED EXTERNAL WORKS
AT VLEIFONTEIN, VHEMBE DISTRICT**

FIBRE-CEMENT WINDOW SILLS

Fibre cement FC77 or equal and approved natural grey sills in single lengths bedded in class I mortar including metal fixing lugs etc

32	15 x 150mm Wide cills set flat and slightly projecting	m	97	
----	--	---	----	--

PAVING (PROVISIONAL)

100 x 200mm "Concor Bondbrick" or similar approved bevelled pre-cast concrete paving (25MPa minimum compressive strength):

33	60mm Thick patterned laid in stretcher bond with continuous joint in one direction and interlocking as per Architectural drawings and specifications	m2	177	
----	--	----	-----	--

Carried to Collection

R

Section No. 2
Bill No 3 - Masonry
LDPW-B/20151 - BILLS OF QUANTITIES

**CONSTRUCTION OF NEW LIBRARY
INCLUDING ELECTRICAL, MECHANICAL INSTALLATION
AND ASSOCIATED EXTERNAL WORKS
AT VLEIFONTEIN, VHEMBE DISTRICT**

Section No. 2

Bill No. 3

Bill No 3 - Masonry

COLLECTION

Total Brought Forward from Page No.

**Page
No**

202

Amount

Total Brought Forward from Page No.

203

Total Brought Forward from Page No.

204

Total Brought Forward from Page No.

205

Total Brought Forward from Page No.

206

Total Brought Forward from Page No.

207

Carried Forward to Summary of Section No. 2

R

Section No. 2

Bill No 3 - Masonry

LDPW-B/20151 - BILLS OF QUANTITIES

**CONSTRUCTION OF NEW LIBRARY
INCLUDING ELECTRICAL, MECHANICAL INSTALLATION
AND ASSOCIATED EXTERNAL WORKS
AT VLEIFONTEIN, VHEMBE DISTRICT**

Item No		Quantity	Rate	Amount
	<u>BILL NO. 5</u>			
	<u>WATERPROOFING</u>			
	<u>(WORK GROUP 120)</u>			
	<u>PREAMBLES</u> For preambles refer to <u>"Department of Public Works: Specification of Materials and Method to be used - PW371"</u>			
	<u>DAMPPROOFING OF WALLS AND FLOORS</u>			
	<u>SUPPLEMENTARY PREAMBLES</u>			
	Waterproofing to flat concrete roofs shall be installed by an approved firm of "Specialist Contractor" under a " <u>ten year guarantee</u> " all in accordance with the materials supplied and methods employed by Manufacturers			
	<u>DAMP-PROOFING OF WALLS AND FLOORS</u>			
	<u>One layer of type 375 micron Consol Plastics Brikgrip DPC or equal and approved embossed damp proof course</u>			
1	In walls	m2	245	
	<u>One layer of 250 micron USB green medium density waterproof sheeting sealed at laps with pressure sensitive tape all in accordance with the Manufacturer's instruction</u>			
2	Medium density damp-proof membrane laid loose on top of sand bed (elsewhere) under solid floors with pressure sensitive tape jointing in building	m2	882	
	Carried to Collection			R
	Section No. 2 Bill No 4 - Waterproofing LDPW-B/20151 - BILLS OF QUANTITIES			

**CONSTRUCTION OF NEW LIBRARY
INCLUDING ELECTRICAL, MECHANICAL INSTALLATION
AND ASSOCIATED EXTERNAL WORKS
AT VLEIFONTEIN, VHEMBE DISTRICT**

JOINT SEALANTS ETC

**Silicone sealing compound including backing cord,
bond breaker, primer, etc**

3	Between timber fittings and plastered walls	m	30	
---	---	---	----	--

4	Between sanitary fittings and wall tiles	m	53	
---	--	---	----	--

Natural grey polysulphide sealing compound

5	20mm Deep in Expansion joints	m	15	
---	-------------------------------	---	----	--

Carried to Collection

R

Section No. 2
Bill No 4 - Waterproofing
LDPW-B/20151 - BILLS OF QUANTITIES

**CONSTRUCTION OF NEW LIBRARY
INCLUDING ELECTRICAL, MECHANICAL INSTALLATION
AND ASSOCIATED EXTERNAL WORKS
AT VLEIFONTEIN, VHEMBE DISTRICT**

Section No. 2

Bill No. 4

Bill No 4 - Waterproofing

COLLECTION

Total Brought Forward from Page No.

Total Brought Forward from Page No.

**Page
No**

209

210

Amount

Carried Forward to Summary of Section No. 2

R

Section No. 2

Bill No 4 - Waterproofing

LDPW-B/20151 - BILLS OF QUANTITIES

**CONSTRUCTION OF NEW LIBRARY
INCLUDING ELECTRICAL, MECHANICAL INSTALLATION
AND ASSOCIATED EXTERNAL WORKS
AT VLEIFONTEIN, VHEMBE DISTRICT**

Item No		Quantity	Rate	Amount
	<p><u>BILL NO. 6</u></p> <p><u>ROOF COVERING</u></p> <p><u>(WORK GROUP 124)</u></p> <p><u>PREAMBLES</u>For preambles refer to <u>"Department of Public Works: Specification of Materials and Method to be used - PW371"</u></p> <p><u>NOTE</u></p> <p>All prices/rates to be net, excluding Value Added Tax</p> <p><u>SUPPLEMENTARY PREAMBLES</u></p> <p>General</p> <p>All roof coverings, etc., to be with a covering of Z275 galvanising. All holes to be drilled and not punched</p> <p>Sizes</p> <p>All items are measured net unless otherwise described</p> <p>Flashing, trimming plates, etc</p> <p>Prices to include for all cutting and waste and relevant fixing material, unless otherwise described</p> <p>All rates for flashings, trimmings, etc., to include for forming drips and closed ends to troughs of sheet roof covering where applicable</p>			
	Carried to Collection		R	
	<p>Section No. 2 Bill No 5 - Roof Covering LDPW-B/20151 - BILLS OF QUANTITIES</p>			

**CONSTRUCTION OF NEW LIBRARY
INCLUDING ELECTRICAL, MECHANICAL INSTALLATION
AND ASSOCIATED EXTERNAL WORKS
AT VLEIFONTEIN, VHEMBE DISTRICT**

ROOF COVERINGS

SUPPLEMENTARY PREAMBLES

"Global Roofing Solution" or similar and approved

ArcelorMittal products to be all galvanised and installed strictly to manufacturer's specifications but colours to be to the Architect's approval

0.58mm Thick 900mm cover "klip-Tite profile chromadek Z200 spelter ISQ550 Dark Dolphin finish coat and Pebble Grey backing coat galvanised steel roof sheeting, fixed to steel intermediate purlins at MAX 2500mm centres and eaves and ridge purlins at MAX 2100mm centres using KL700 plus clips fixed with 10No. 16 x 16mm long self-drilling water haed PH2 screws.

1	Roof covering with pitches not exceedin 25 degrees	m2	1 098
---	--	----	-------

INSULATION. ETC

Roof insulation "Owens" or similar and approved by the Principal Agent Corning Factorylite flexible, non-combustible lightweight industrial fibreglass insulation material (nominal density 12kg per m3), with reinforced kraft aluminium foil faced finish laid taut over purlins at centres and tied down top and bottom after tensioning with galvanized hoop iron ties, all strictly to the manufacturer's specifications

2	100mm Thick Insulation	m2	1 098
---	------------------------	----	-------

Carried to Collection

R

Section No. 2
Bill No 5 - Roof Covering
LDPW-B/20151 - BILLS OF QUANTITIES

**CONSTRUCTION OF NEW LIBRARY
INCLUDING ELECTRICAL, MECHANICAL INSTALLATION
AND ASSOCIATED EXTERNAL WORKS
AT VLEIFONTEIN, VHEMBE DISTRICT**

**SHEET METAL FLASHING, LININGS,
COPING, ETC**

Concealed fix 0,8mm thick "Global Roofing Solution" or similar and approved by the Principal Agent Chromadek Z200 spelter ISQ550 Charcoal Grey finish top coat and Pebble Grey backing coat galvanised steel sheeting flashing, three times bent along girth and notched on site to suit roof profile, complete with sealing strips

3	Apex flashing 550mm girth 3 times bent and notched on site	m	50
4	Sidewall flashing 550mm girth 2 times bent and notched on site	m	34
5	Headwall flashing 462mm girth 2 times bent and notched on site	m	34
6	Ridge Cap 550mm girth 3 times bent and notched on site	m	50

0,8mm Z275 "Brownbuilt" spelter galvanised steel sheeting

7	Fascia or barge angles 500mm girth with "Classicoat" finish on one side	m	324
---	---	---	-----

Carried to Collection

R

Section No. 2
Bill No 5 - Roof Covering

LDPW-B/20151 - BILLS OF QUANTITIES

**CONSTRUCTION OF NEW LIBRARY
INCLUDING ELECTRICAL, MECHANICAL INSTALLATION
AND ASSOCIATED EXTERNAL WORKS
AT VLEIFONTEIN, VHEMBE DISTRICT**

SKYLIGHTS

PREAMBLES

Notes:

ALUMINIUM WINDOWS, ETC..

NOTE: Indicative schedules are attached at the end of the bills of quantities to assist the tenderer in pricing

Rates for the following aluminium windows are to include for supplying and building in of temporary templates

Design, supply, deliver to site and install the following skylights in accordance with the manufacturers instructions

Skylight with 8.38mm thick "SmartGlass" or similar and approved x 2 Pro, Double glazing "seren green", outer pane armourplate and inner pane clearvue, of visible light transmission to, solar heat gain co-efficient 0.52, u-value 2.8 and visible light reflection 13 and shading co-efficient 0.60. Skylight to have seamless glass and sides to be of approved standard.

Skylight glazed with 6mm thick PVB faidbrand laminated safety glass and plugged to brickwork

8	Skylight type 1 size 1000 x 600mm wide	No	6.00	
9	"SUNPAL" Multi polycarbonate standing seam Architectural system or similar and approved by the Principal Agent to suite opening approximately 1000 x 600mm wide	No	6.00	

Carried to Collection

R

Section No. 2
Bill No 5 - Roof Covering
LDPW-B/20151 - BILLS OF QUANTITIES

**CONSTRUCTION OF NEW LIBRARY
INCLUDING ELECTRICAL, MECHANICAL INSTALLATION
AND ASSOCIATED EXTERNAL WORKS
AT VLEIFONTEIN, VHEMBE DISTRICT**

Section No. 2

Bill No. 5

Bill No 5 - Roof Covering

COLLECTION

Total Brought Forward from Page No.

**Page
No**

212

Amount

Total Brought Forward from Page No.

213

Total Brought Forward from Page No.

214

Total Brought Forward from Page No.

215

Carried Forward to Summary of Section No. 2

R

Section No. 2

Bill No 5 - Roof Covering

LDPW-B/20151 - BILLS OF QUANTITIES

**CONSTRUCTION OF NEW LIBRARY
INCLUDING ELECTRICAL, MECHANICAL INSTALLATION
AND ASSOCIATED EXTERNAL WORKS
AT VLEIFONTEIN, VHEMBE DISTRICT**

Item No		Quantity	Rate	Amount
	<p><u>BILL NO. 7</u></p> <p><u>CARPENTRY AND JOINERY</u></p> <p><u>(WORK GROUP 126)</u></p> <p><u>PREAMBLES</u>For preambles refer to <u>"Department of Public Works: Specification of Materials and Method to be used - PW371"</u></p> <p><u>NOTE</u></p> <p>All prices/rates to be net, excluding Value Added Tax</p> <p><u>SUPPLEMENTARY PREAMBLES</u></p> <p>Fixing</p> <p>Items described as "nailed" shall be deemed to be fixed with hardened steel nails or shot pins to brickwork or concrete</p> <p>Items described as "plugged" shall be deemed to include screwing to fibre, plastic or metal plugs at maximum 600mm centres, and where described as "bolted" the bolts have been given elsewhere</p> <p>Sealing of all abutments</p> <p>All cupboards, counter tops, shelves, etc. abutting walls, tiled surfaces, etc. to be sealed watertight with an approved silicon sealant along all joints</p> <p>Unless described, tendered rates must make provision for this as no additional claims in this regard will afterwards be entertained</p>			
	Carried to Collection			R
	<p>Section No. 2 Bill No 6 - Carpentry and Joinery LDPW-B/20151 - BILLS OF QUANTITIES</p>			

**CONSTRUCTION OF NEW LIBRARY
INCLUDING ELECTRICAL, MECHANICAL INSTALLATION
AND ASSOCIATED EXTERNAL WORKS
AT VLEIFONTEIN, VHEMBE DISTRICT**

PREAMBLES

NOTE: Tenders are advised to study the "Department of public works specifications of material and method to be used" (PW371/OCTOBER 1993) before pricing this bill

NOTE: Unless otherwise stated herein all items in this bill shall be deemed to fall into Work Group No.126 for JBCC CPAP Purpose

TIMBER

All softwood to be South African Pine.

DESCRIPTION

The term "screwed on" shall mean the countersunk screwing of one timber member to another

The term "plugged" shall mean the countersunk screwing of a timber member to and including plastic plugs in brickwork or concrete

Descriptions of floors, ceiling, joinery, etc. shall be deemed to include for all square cutting

Descriptions of items given in linear meter shall be deemed to include for mitres, stopped ends, fitted intersections, etc.

Descriptions of rounded angles, rebates, grooves, chamferes, moulded edges, etc, shall be deemed to include for angles, ends, etc.

ROOFS ETC

The following is applicable in respect of roof trusses

Trusses are at maximum 760mm centres

Carried to Collection

Section No. 2
Bill No 6 - Carpentry and Joinery
LDPW-B/20151 - BILLS OF QUANTITIES

R

**CONSTRUCTION OF NEW LIBRARY
INCLUDING ELECTRICAL, MECHANICAL INSTALLATION
AND ASSOCIATED EXTERNAL WORKS
AT VLEIFONTEIN, VHEMBE DISTRICT**

Roof coverings are Double Roman Concrete Roof Tiles, laid on 38 x 38mm Sawn softwood brandering, at centres to suit the gauge of tiles and PVC translucent sheeting laid on 50 x 76mm timber purlins

NOTE:

Tiles to match existing in all respects. If there are challenges in matching the tiles, the Contractor to notify the Architect prior to procurement and installation. Works to roof covering are mostly in patchwork and the Contractor to take cognisance that skew views will not be tolerated in the name of what was existing. Rates will be deemed to include correcting discrepancies on existing work.

All prefabricated trusses are to be approved by the Structural Engineer and the Contractor to price for design, workshop drawings and certification by ITC approved manufacturer.

Upon completion of the roofing installation, the Contractor shall call upon own and independant Structural Engineer, who will certify the installation as compliant to design, and issue a roof guarantee certificate, with costs included in the rates.

Plate nailed mono pitch timber roof truss construction

All prices/rates to be net, excluding Value Added Tax

PREFABRICATED ROOF TRUSSES. ETC.

- | | | | | |
|---|--|--|------|--|
| 1 | Allow for the issuing of all relevant roof truss design certificates as per SANS 0243: THE DESIGN, MANUFACTURE AND ERECTION OF TIMBER TRUSSES. | | Item | |
|---|--|--|------|--|

Prefabricated timber trusses with not exceeding 15 degree pitch.

- | | | | | |
|---|--|----|---|--|
| 2 | Roof truss approximately 6500 x 1200mm high of prefabricated trusses to Guard house. | No | 6 | |
|---|--|----|---|--|

Carried to Collection

R

Section No. 2
Bill No 6 - Carpentry and Joinery
LDPW-B/20151 - BILLS OF QUANTITIES

**CONSTRUCTION OF NEW LIBRARY
INCLUDING ELECTRICAL, MECHANICAL INSTALLATION
AND ASSOCIATED EXTERNAL WORKS
AT VLEIFONTEIN, VHEMBE DISTRICT**

Sawn softwood

3	22 x 228mm Gang boarding (Provisional).	m	11
4	38 x 114mm Longitudinal bracing (Provisional).	m	12
5	50 x 76mm Cross bracing (Provisional).	m	8
6	38 x 114mm Wall plates	m	7
7	50 x 76mm Purlins	m	79

Wrought softwood

8	50 x 76mm Purlins	m	13
---	-------------------	---	----

Sundries

9	Two coats ABE PROVONITE on exposed timbers	m2	5
10	Teco Hurricane galvanised mild steel purlin to rafter ties fixed in strict accordance with the manufacturers instructions	No	24

EAVES, VERGES, ETC

Everite medium density plain nutec-cement

11	12 x 225mm Fascia with plastic H-profile joint strips, screwed to timber with 14 x 40mm brass screws	m	14
12	12 x 225mm Barge boards with plastic H-profile joint strips, screwed to timber with 14 x 40mm brass screws	m	13

Carried to Collection

R

Section No. 2
Bill No 6 - Carpentry and Joinery

LDPW-B/20151 - BILLS OF QUANTITIES

**CONSTRUCTION OF NEW LIBRARY
INCLUDING ELECTRICAL, MECHANICAL INSTALLATION
AND ASSOCIATED EXTERNAL WORKS
AT VLEIFONTEIN, VHEMBE DISTRICT**

SKIRTINGS

Timber skirting

13	75 x 19mm Thick hardwood skirting with rounded top and complete with 25mm hardwood quadrant planted on and plugged and screwed to walls, all expansion joints in skirting to be formed with 10mm polysulphide filled joint	m	76
----	--	---	----

Hard wood board

14	200mm x 600mm x 22 mm Fire extinguisher backing board, chamfered all round and plugged to wall including varnish on all sides	No	11
----	---	----	----

DOORS. ETC

NOTE:

All framed and ledged batten doors and combination doors, where battens are utilised, shall only be of construction acceptable to the Department, i.e. mortice and tennon where the tennon is exposed on the outside edges of styles and where the tennon is wedged to form a dovetailed shape.

Paint backs of subframes one coat wood primer before building in all timber frame

HARDWOOD DOORS. ETC

Meranti framed, ledged, braced and battened door, formed of 110 x 44mm sides, 110 x 44mm top rail, 110 x 22mm middle rail, top and bottom brace and 220 x 44mm bottom rail, all filled in with 63mm tongue and groove slats and 3mm hardwood backing board

15	44mm Door size 813 x 2032mm high for door type D1, D5	No	15
----	---	----	----

16	44mm Door size 913 x 2032mm high door type D3, D6	No	2
----	---	----	---

Carried to Collection

R

Section No. 2
Bill No 6 - Carpentry and Joinery
LDPW-B/20151 - BILLS OF QUANTITIES

**CONSTRUCTION OF NEW LIBRARY
INCLUDING ELECTRICAL, MECHANICAL INSTALLATION
AND ASSOCIATED EXTERNAL WORKS
AT VLEIFONTEIN, VHEMBE DISTRICT**

SEMI-SOLID DOORS, ETC

**Flush Semi-solid core meranti doors with concealed
hardwood edge and 3mm masonate on both side
hung to steel doorframe**

JOINERY FITTINGS

17	Provide an amount of R 50,000,000 (Five thousand rands) for reception counter in building to the required standards all as directed by the principal agent	Item	50 000.00
18	Profit	Item	
19	Attendance	Item	
20	Provide an amount of R 20,000,000 (Twenty thousand rands) for Kitchen Unit in building to the required standards all as directed by the principal agent	Item	20 000.00
21	Profit	Item	
22	Attendance	Item	
23	Provide an amount of R 100,000,000 (One Hundred thousand rands) for Counter tops in building to the required standards all as directed by the principal agent	Item	100 000.00
24	Profit	Item	
25	Attendance	Item	50 000.00
26	Provide an amount of R 50,000,000 (Five thousand rands) for Computer centre in building to the required standards all as directed by the principal agent	Item	
27	Profit	Item	
28	Attendance	Item	

Carried to Collection

R

Section No. 2
Bill No 6 - Carpentry and Joinery
LDPW-B/20151 - BILLS OF QUANTITIES

**CONSTRUCTION OF NEW LIBRARY
INCLUDING ELECTRICAL, MECHANICAL INSTALLATION
AND ASSOCIATED EXTERNAL WORKS
AT VLEIFONTEIN, VHEMBE DISTRICT**

29	Provide an amount of R 200,000,000 (Two Hundred thousand rands) for Book Shelves in building to the required standards all as directed by the principal agent	Item	200 000.00
30	Profit	Item	
31	Attendance	Item	

Carried to Collection

R

Section No. 2
Bill No 6 - Carpentry and Joinery
LDPW-B/20151 - BILLS OF QUANTITIES

**CONSTRUCTION OF NEW LIBRARY
INCLUDING ELECTRICAL, MECHANICAL INSTALLATION
AND ASSOCIATED EXTERNAL WORKS
AT VLEIFONTEIN, VHEMBE DISTRICT**

Section No. 2

Bill No. 6

Bill No 6 - Carpentry and Joinery

COLLECTION

Total Brought Forward from Page No.

**Page
No**

217

Amount

Total Brought Forward from Page No.

218

Total Brought Forward from Page No.

219

Total Brought Forward from Page No.

220

Total Brought Forward from Page No.

221

Total Brought Forward from Page No.

222

Total Brought Forward from Page No.

223

Carried Forward to Summary of Section No. 2

R

Section No. 2

Bill No 6 - Carpentry and Joinery

LDPW-B/20151 - BILLS OF QUANTITIES

**CONSTRUCTION OF NEW LIBRARY
INCLUDING ELECTRICAL, MECHANICAL INSTALLATION
AND ASSOCIATED EXTERNAL WORKS
AT VLEIFONTEIN, VHEMBE DISTRICT**

Item No		Quantity	Rate	Amount
	<p><u>BILL NO. 8</u></p> <p><u>CEILING, PARTITIONS AND ACCESS FLOORING</u></p> <p><u>(WORK GROUP 129)</u></p> <p><u>PREAMBLES</u>For preambles refer to <u>"Department of Public Works: Specification of Materials and Method to be used - PW371"</u></p> <p><u>NOTE</u></p> <p>All prices/rates to be net, excluding Value Added Tax</p> <p><u>SUPPLEMENTARY PREAMBLES</u></p> <p>Fixing</p> <p>Items described as "nailed" shall be deemed to be fixed with hardened steel nails or shot pins to brickwork or concrete</p> <p>Items described as "plugged" shall be deemed to include screwing to fibre, plastic or metal plugs at maximum 600mm centres, and where described as "bolted" the bolts have been given elsewhere</p> <p>Ceilings</p> <p>Unless otherwise described, ceilings shall be deemed to be horizontal</p> <p>Suspended ceilings, bulkheads, etc</p> <p>All suspended ceilings, bulkheads, etc. shall be installed by an approved firm of specialists, all in accordance with the materials supplied and methods employed by Manufacturer</p> <p>Proprietary suspended ceilings</p>			
	Carried to Collection			R
	<p>Section No. 2 Bill No 7 - Ceilings, Partitions and access flooring LDPW-B/20151 - BILLS OF QUANTITIES</p>			

**CONSTRUCTION OF NEW LIBRARY
INCLUDING ELECTRICAL, MECHANICAL INSTALLATION
AND ASSOCIATED EXTERNAL WORKS
AT VLEIFONTEIN, VHEMBE DISTRICT**

Hangers, suspension grids, "lay-in" panels, etc. of suspended ceilings, bulkheads, etc are to be in accordance with the Manufacturers recommendation

Bulkheads

Bulkhead are defined as those portions of ceilings which are stepped vertically down or up from the general ceiling level and which generally occur along the perimeter of a room or area

Bulkheads have only been described as such where they conform to the above defination and where the horizontal or vertical dimensions do not exceed 900mm. Where these dimensions do exceed 900mm, such portions of ceilings have been included in the appropriate general items of ceilings

Unless otherwise described, bulkheads shall be deemed to be horizontal along the length

INSULATION

"Aerolite" or similar and approved by the Principal Agent thermal Insulation

1	135mm Insulation "Owen Corning Aerolite" flexible non-combustible lightweight (nominal density 10kg/m3) fibreglass reinforced insulation blanket, closely fitted with ends butted firmly and laid loose on top of brandering etc	m2	883
---	--	----	-----

Carried to Collection

R

Section No. 2
Bill No 7 - Ceilings, Partitions and access flooring
LDPW-B/20151 - BILLS OF QUANTITIES

**CONSTRUCTION OF NEW LIBRARY
INCLUDING ELECTRICAL, MECHANICAL INSTALLATION
AND ASSOCIATED EXTERNAL WORKS
AT VLEIFONTEIN, VHEMBE DISTRICT**

CEILING, ETC

NAILED UP CEILINGS

Note:

The tenderer shall make allowance in the ceilings for electrical light fittings, diffusers, panels, etc and for their support inclusive of any flexibility in setting out that may be required (ceiling panels have not been deducted and pricing is to take cognisance thereof)

Tenderers are advised to make allowance in their prices for ceiling subframes where required

PLASTERED PLASTERBOARD CEILINGS

BPB "Gypsum" RhinoCeil Prestige J flush jointed ceiling 9,5mm thick Taper-edge Rhinoboard fixed print side up and screwed to Donn steel capped tee flush plastered ceiling suspension system with drywall screws spaced at 150mm centres, including galvanised main tees at 1200mm centres and cross tees at 500mm centres, all suspended with 25 x 25mm galvanised angles at not exceeding 1200mm centres., all fixed to truses at centres. Joints to taped and finished as per manufacturerers instructions

2	Gypsum board ceilings to timber trusses	m2	16		
3	Skimmed gypsum plaster on ceilings	m2	161		
<u>BPB Gypsum Cornice</u>					
4	45 x 35mm flush plaster trim(9,5mm thick) cornice plugged to straight walls	m	192		
5	Extra over ceiling for opening for 650 x 650 mm trap door complete with trimmers, frame, cross branders, ceiling board, hinges, etc	No	5		

Carried to Collection

R

Section No. 2
Bill No 7 - Ceilings, Partitions and access flooring
LDPW-B/20151 - BILLS OF QUANTITIES

**CONSTRUCTION OF NEW LIBRARY
INCLUDING ELECTRICAL, MECHANICAL INSTALLATION
AND ASSOCIATED EXTERNAL WORKS
AT VLEIFONTEIN, VHEMBE DISTRICT**

SUSPENDED CEILINGS

Ceilings "BPB Gypsum DonnCeil Gyprex" white vinyl finished gypsum ceiling tiles 12,5mm thick, laminated to glass wool board of 55mm x 60kg/m3, laid on and including Q/T38 White powder coated main tees, cross tees, hold-down clips, wedges, etc., all suspended with galvanized hangers at centres not exceeding 1200mm

6	1200 x 600mm Suspended Ceilings not exceeding 1m below steel members	m2	122
---	--	----	-----

ACOUSTIC CEILINGS

Ceilings "OW Acoustic" Constellation Premium biologically absorbable mineral woll ceiling tile, NRC -0.70, CAC -33dB, fire classification A2-s1, d0, weight - 4.5kg/m2, white vinyl finished, laid on fire rated OWA construct S15 exposed demountable T15 suspension system, with galvanised main tees and cross tees, tees suspended by means of galvanised hangers at centres not exceeding 1200mm, all installed to manufacturer's specifications.

7	1200 x 600mm Suspended Ceilings not exceeding 1m below steel members	m2	320
---	--	----	-----

"BPB Gypsum" Code LSM25 recessed shadowline cornice pluggged

8	Type SM25 47 X 35mm pre-painted cornices	m	211
---	--	---	-----

ACCESS FLOORING

"Bates" access flooring or similar approved

9	"Bates" access flooring or similar approved access flooring 600 x 600mm wide with 3CR12 suspension foot pieces not exceeding 1000mm deep.	m	6
---	---	---	---

Carried to Collection

R

Section No. 2
Bill No 7 - Ceilings, Partitions and access flooring
LDPW-B/20151 - BILLS OF QUANTITIES

**CONSTRUCTION OF NEW LIBRARY
INCLUDING ELECTRICAL, MECHANICAL INSTALLATION
AND ASSOCIATED EXTERNAL WORKS
AT VLEIFONTEIN, VHEMBE DISTRICT**

Section No. 2

Bill No. 7

Bill No 7 - Ceilings, Partitions and access flooring

COLLECTION

Total Brought Forward from Page No.

**Page
No**

225

Amount

Total Brought Forward from Page No.

226

Total Brought Forward from Page No.

227

Total Brought Forward from Page No.

228

Carried Forward to Summary of Section No. 2

R

Section No. 2

Bill No 7 - Ceilings, Partitions and access flooring

LDPW-B/20151 - BILLS OF QUANTITIES

**CONSTRUCTION OF NEW LIBRARY
INCLUDING ELECTRICAL, MECHANICAL INSTALLATION
AND ASSOCIATED EXTERNAL WORKS
AT VLEIFONTEIN, VHEMBE DISTRICT**

Item No		Quantity	Rate	Amount
	<p><u>BILL NO. 10</u></p> <p><u>IRONMONGERY</u></p> <p><u>(WORK GROUP 132)</u></p> <p><u>PREAMBLES</u>For preambles refer to <u>"Department of Public Works: Specification of Materials and Method to be used - PW371"</u></p> <p><u>NOTE</u></p> <p>All prices/rates to be net, excluding Value Added Tax</p> <p><u>SUPPLEMENTARY PREAMBLES</u></p> <p>Fixing of door locks, handles, flush bolts etc</p> <p>Fixing of all locks, handles, flush bolt, etc. shall be regarded as fixed to timber door leaves, unless specifically otherwise indicated</p> <p>Preparation of door frames</p> <p>Descriptions for flush bolts, door closers, floor spring, etc. shall be deemed to include all necessary preparations to door frames to accomodate same.</p> <p>Tendered rates must make provision for the above-mentioned as no additional claims in this regards will afterwards be entertained</p> <p>All "en-suite" locks shall be ordered to operate in a dedicated master keyed and/or grand master keyed lock system</p>			
	Carried to Collection		R	
	<p>Section No. 2 Bill No 8 - Ironmongery LDPW-B/20151 - BILLS OF QUANTITIES</p>			

**CONSTRUCTION OF NEW LIBRARY
INCLUDING ELECTRICAL, MECHANICAL INSTALLATION
AND ASSOCIATED EXTERNAL WORKS
AT VLEIFONTEIN, VHEMBE DISTRICT**

**SUPPLY AND INSTALLATION OF
IRONMONGERY**

HINGES, BOLTS, ETC

**"Dormakapa" or similar and approved by the
Principal Agent**

1	Type DBB-SS-009 102 x 75 x 3mm Thick two ball bearing butt hinge	No	45
2	Type BFBDM Aluminium anodised flush barrel bolt, with keep fixed to manufacturer's specification	No	6
3	Type HBAFM Hinge for aluminium frame.	No	10
4	Type DRP-SS-022, Adjustable roller bolt	No	2
5	Type HBFMF, Fire Hose reel cabinet door	No	3

"EN-SUITE" LOCKS

"Dormakapa" Locks to be suitable for Master Key

6	Type D02735 SS Narrow stile dead lock operating with european profile cylinder, casing 174 x 52mm deep, forend 238 x 22mm wide, backset 35mm and 20mm throw.	No	12
7	Type D02635 SS Narrow stile Sash lock operating with european profile cylinder, casing 174 x 52mm deep, forend 238 x 22mm wide, backset 35mm and 20mm throw.	No	3
8	Type D037D SS Cylinder deadlock, casing 116.5 x 78mm deep, forend 168 x 22mm wide and backset 57mm.	No	4
9	Type D032D SS, Bathroom deadlock, casing 102 x 78mm deep, forend 155 x 22mm wide and backset 57mm.	No	1

Carried to Collection

R

Section No. 2
Bill No 8 - Ironmongery

LDPW-B/20151 - BILLS OF QUANTITIES

**CONSTRUCTION OF NEW LIBRARY
INCLUDING ELECTRICAL, MECHANICAL INSTALLATION
AND ASSOCIATED EXTERNAL WORKS
AT VLEIFONTEIN, VHEMBE DISTRICT**

10	Type DDC106601MK Five pin Euro-profile double cylinder 66mm long	No	16		
11	Type DCE-105 S.S Narrow Stile cylinder escutcheon	No	8		
12	Type DCE-002 S.S Round cylinder escutcheon	No	6		
13	Type D035S SS Bathroom sash lock, casing 102 x 78mm Deep, forend 155 x 22mm wide, backset 57mm and centres 57mm	No	5		
14	Type D036S SS, Cylinder sash lock, casing 116.5 x 78mm Deep, forend 168 x 22mm wide, backset 57mm and centres 61mm	No	1		
15	Type DKC106601 MK 66mm Long five pin euro-profile knob cylinder master keyed.	No	1		
16	Type DSC104301 MK 43mm Long five pin euro-profile knob cylinder master keyed.	No	4		
17	Type PHT3901, Exterior access lock with lever handle	No	1		
18	Master key	No	2		
19	Grand master key	No	1		
<u>HANDLES</u>					
<u>"Dormakapa" or similar and approved by the Principal Agent</u>					
20	Type TH125 NS Cyl S.S Lever handle on narrow stile rose with narrow stile cylinder escutcheons	No	9		
21	Type DPH215 BTB 383 x 32mm Dia. D Shaped offset tubular pull handle	No	14		
22	Type DPH301A BTB 383 x 25mm Dia. straight tubular pull handle	No	1		
23	Type DPH301B, 325 x 25mm Dia. straight tubular pull handle	No	2		
Carried to Collection					
				R	
Section No. 2 Bill No 8 - Ironmongery LDPW-B/20151 - BILLS OF QUANTITIES					

**CONSTRUCTION OF NEW LIBRARY
INCLUDING ELECTRICAL, MECHANICAL INSTALLATION
AND ASSOCIATED EXTERNAL WORKS
AT VLEIFONTEIN, VHEMBE DISTRICT**

24	Type DPH-430-BL-SF Pull handle BT fixed on a plate (Plate elsewhere measured) with no cylinder cutout, installed to manufacturer's specification.	No	3		
25	Type DWC-006, Disabled WC indicator and turnknob for physically impaired individuals.	No	1		
26	Type TH125 WC S.S, Lever handle on rose for Bathroom/WC	No	10		
27	Type DRP-SS-023, Flush pull handle 62 x 44mm ring	No	2		
Carried to Collection					
Section No. 2					
Bill No 8 - Ironmongery					
LDPW-B/20151 - BILLS OF QUANTITIES					

R

**CONSTRUCTION OF NEW LIBRARY
INCLUDING ELECTRICAL, MECHANICAL INSTALLATION
AND ASSOCIATED EXTERNAL WORKS
AT VLEIFONTEIN, VHEMBE DISTRICT**

PUSH PLATES AND KICKING PLATES

**"Dormakapa" or similar and approved by the
Principal Agent Pushplate drilled and counter sunk
to timber**

Pushplates

28	Type DPP-430-BL-SF 150 X 300 X 1,2mm Thick push plates fixed to timber door	No	3	
----	---	----	---	--

Kickplate drilled and counter sunk to timber

29	Type DKP-430-SF, 300 wide x 1,2mm Thick Kick plate fixed to timber door	No	15	
----	---	----	----	--

DOOR CLOSERS AND FLOOR SPRINGS

**"Dorma" or other equal and approved by the
Principal Agent**

30	Type TS71 PA HO (EN3 850-950, EN4 950-1100) parallel arm bracket, hold open door closer - hydraulic speed control, installed to manufacturer's specification.	No	12	
----	---	----	----	--

31	Type TS71 (EN3 850-950, EN4 950-1100) parallel arm bracket, non hold open door closer - hydraulic speed control, installed to manufacturer's specification.	No	4	
----	---	----	---	--

32	Type TS73V PA DC-PAB-SL (EN3 850-950, EN4 950-1100) parallel arm delayed action, installed to manufacturer's specification.	No	1	
----	---	----	---	--

33	Type TS91B G-SR, Non hold co-ordinated door closer system for rebated doors between 1350 - 1900mm, closing force EN3, with hydraulic speed control for door maximum 950mm per leaf, installed to manufacturer's specification.	No	1	
----	--	----	---	--

34	Type BTS75 SSA-NHO Single action stainless steel floorspring, EN 1-4 non hold open type, for 120Kg door leaf weight, with adjustable closing and latching speeds, backcheck.	No	2	
----	--	----	---	--

Carried to Collection

R

Section No. 2

Bill No 8 - Ironmongery

LDPW-B/20151 - BILLS OF QUANTITIES

**CONSTRUCTION OF NEW LIBRARY
INCLUDING ELECTRICAL, MECHANICAL INSTALLATION
AND ASSOCIATED EXTERNAL WORKS
AT VLEIFONTEIN, VHEMBE DISTRICT**

35	Type SR 392 Door co-ordinator for door leaf widths more than 800mm	No	7		
<u>KIMBERLEY CLARK</u>					
36	"Kimberley Clark" pump action soap dispenser code SA921950,	No	6		
37	Stainless steel toilet paper (TR2) holder	No	6		
38	Stainless steel folded towel dispenser code 9962000	No	4		
39	Reflex sanitary stainless steel disposal bin 12 litre pedal operated	No	6		
40	Reflex stainless steel diposal bin 18.6 litre	No	4		
<u>GRAB RAILS</u>					
<u>"Chairman industries" or other equal and approved</u>					
41	Stainless steel side grab rail " Code DL2 " including fixing to wall	No	1		
42	Stainless steel rear grab rail " Code SR2 " including fixing to wall around cistern	No	1		
43	GR300 Stainless steel door rail and fixing to timber door	No	1		
<u>SUNDRIES</u>					
<u>"Dormakapa" or similar and approved by the Principal Agent</u>					
44	Type DPS-SS-032 Dust proof strike	No	6		
45	Type DDS-NP-018 Floor mounted door stop fixed to concrete	No	26		
46	Type DDH-SS-020, Wall mounted door buffer fixed to brickwork.	No	2		
Carried to Collection					R
Section No. 2					
Bill No 8 - Ironmongery					

**CONSTRUCTION OF NEW LIBRARY
INCLUDING ELECTRICAL, MECHANICAL INSTALLATION
AND ASSOCIATED EXTERNAL WORKS
AT VLEIFONTEIN, VHEMBE DISTRICT**

LDPW-B/20151 - BILLS OF QUANTITIES

**CONSTRUCTION OF NEW LIBRARY
INCLUDING ELECTRICAL, MECHANICAL INSTALLATION
AND ASSOCIATED EXTERNAL WORKS
AT VLEIFONTEIN, VHEMBE DISTRICT**

47	Type DHC-SS-031B, Hat and coat hook with rubber buffer, fixed to timber	No	5		
48	Type PHA3 S DD, Three point locking panic bar - double door suitable for door double leaf 1000 x 2270mm high.	No	1		
49	Type DPL1000 MK, 50mm Padlock suitable for master key.	No	4		
<u>STEEL LOCKERS</u>					
<u>"KROST SHELVING" or similar approved steel lockers with standard baked enamel finish</u>					
50	Interlocking two door lockers 1800mm High x 300mm Wide x 450mm Deep with 3 doors each side	No	6		
<u>PINNING BOARDS. WRITING BOARDS. PROJECTION SCREENS. ETC</u>					
<u>"Best Board Manufacturing cc" or similar and approved by the Principal Agent</u>					
<u>Pining board in charcola carpet complete with delux anodised aluminium frame, rounded plastic corner and mounted horizontally against the masonry wall with mounting brackets, all in accordance with manufacturer's specifications</u>					
51	Standard pining board size 1200mm wide x 1500mm high	No	12		
<u>SIGNAGE</u>					
<u>"Dormakaba" or similar and approved by the Principal Agent</u>					
52	Type DSS-130 M, 150 x 150mm MALE sign	No	1		
53	Type DSS-131 F, 150 x 150mm FEMALE sign	No	1		
Carried to Collection					
Section No. 2					
Bill No 8 - Ironmongery					
LDPW-B/20151 - BILLS OF QUANTITIES					
				R	

**CONSTRUCTION OF NEW LIBRARY
INCLUDING ELECTRICAL, MECHANICAL INSTALLATION
AND ASSOCIATED EXTERNAL WORKS
AT VLEIFONTEIN, VHEMBE DISTRICT**

54	Type DSS-132 MF, 150 x 150mm MALE/FEMALE sign	No	1		
55	Type DSS-133 P, 150 x 150mm DISABLED PERSONS sign	No	1		
56	Type DSS-136 EL, 150 x 150mm ELECTRICAL sign	No	1		
57	Type DSS-140 RH, 150 x 150mm RUNNING MAN sign	No	1		
58	Type DSS-143 A, 150 x 150mm ARROW sign	No	1		
59	Type DSS-145 FHR, 150 x 150mm FIRE HOSE REEL sign	No	2		
60	Type DSS-146 FE, 150 x 150mm FIRE EXTINGUISHER sign	No	2		
<u>BLINDS AND CURTAINS</u>					
61	Provide a sum of R 50 000.00 (Fifty thousand rands) for supply and installation of curtain trucks, rails, curtains and blinds			Item	50 000.00
62	Profit			Item	
63	Attendance			Item	
Carried to Collection					
					R
Section No. 2 Bill No 8 - Ironmongery LDPW-B/20151 - BILLS OF QUANTITIES					

**CONSTRUCTION OF NEW LIBRARY
INCLUDING ELECTRICAL, MECHANICAL INSTALLATION
AND ASSOCIATED EXTERNAL WORKS
AT VLEIFONTEIN, VHEMBE DISTRICT**

Section No. 2

Bill No. 8

Bill No 8 - Ironmongery

COLLECTION

Total Brought Forward from Page No.

**Page
No**

230

Amount

Total Brought Forward from Page No.

231

Total Brought Forward from Page No.

232

Total Brought Forward from Page No.

233

Total Brought Forward from Page No.

234

Total Brought Forward from Page No.

235

Total Brought Forward from Page No.

236

Total Brought Forward from Page No.

237

Carried Forward to Summary of Section No. 2

R

Section No. 2

Bill No 8 - Ironmongery

LDPW-B/20151 - BILLS OF QUANTITIES

**CONSTRUCTION OF NEW LIBRARY
INCLUDING ELECTRICAL, MECHANICAL INSTALLATION
AND ASSOCIATED EXTERNAL WORKS
AT VLEIFONTEIN, VHEMBE DISTRICT**

Item No	Quantity	Rate	Amount
<p><u>BILL NO. 11</u></p> <p><u>STRUCTURAL STEEL</u></p> <p><u>(WORK GROUP 134)</u></p> <p><u>PREAMBLES</u>For preambles refer to <u>"Department of Public Works: Specification of Materials and Method to be used - PW371"</u></p> <p>All prices/rates to be net, excluding Value Added Tax</p> <p><u>SUPPLEMENTARY PREAMBLES</u></p>			
<p><u>STRUCTURAL STEEL (Provisional)</u></p> <p><u>Standardised Specifications</u></p> <p>The SANS 1200 1200H Standardised Specification for Civil Engineering Construction for Structural Steelwork is applicable to this Bill</p> <p>The SANS 1200 1200HC Standardised Specification for Civil Engineering Construction for Corrosion Protection of Structural Steelwork is applicable to this Bill</p> <p><u>Project Specification</u></p> <p>If the Standardised Specifications and the Project Specification (bounded in this document) are in conflict, the Project Specification shall apply. If these three specifications conflicts with the Model Preambles for Trades, the provisions of these specifications shall apply.</p>			
Carried to Collection			R
<p>Section No. 2 Bill No 9 - Structural Steel LDPW-B/20151 - BILLS OF QUANTITIES</p>			

**CONSTRUCTION OF NEW LIBRARY
INCLUDING ELECTRICAL, MECHANICAL INSTALLATION
AND ASSOCIATED EXTERNAL WORKS
AT VLEIFONTEIN, VHEMBE DISTRICT**

Descriptions

Descriptions of all structural steelwork shall be deemed to include for the preparation of shop detail drawings, supply and fabrication, delivery, abnormal loads, erection and approved protective treatment (Corrosion protection).

Items described as "bolted" shall be deemed to exclude the bolts and include the holes.

Descriptions of bolts shall be deemed to include nuts and washers

Descriptions of expansion anchors and bolts and chemical anchors and bolts shall be deemed to include nuts, washers and mortices in brickwork or concrete

Descriptions of L-shaped and U-shaped anchor bolts shall be deemed to include bending, threading, nuts and washers and embedding in concrete. Where anchor bolts are described as embedded in sides or soffits of concrete it shall be deemed to include holes through formwork.

STRUCTURAL STEEL WORKS, ETC.

1 Contractor to supply workshop drawings to the Principal Agent for approval

Item

2 Allow for the issuing of all relevant roof truss design certificates as per SANS 0243: THE DESIGN, MANUFACTURE AND ERECTION OF STEEL TRUSSES.

Item

3 Certificates of compliance for complete roof installation

Item

MILD STEEL COLUMNS AND BEAMS

Welded and bolted columns in single lengths with welded flat section base and bolted angle section cleats

4 200 x200 x 29.94kg/m Hollow section square columns

t

0.40

Carried to Collection

R

Section No. 2
Bill No 9 - Structural Steel

LDPW-B/20151 - BILLS OF QUANTITIES

**CONSTRUCTION OF NEW LIBRARY
INCLUDING ELECTRICAL, MECHANICAL INSTALLATION
AND ASSOCIATED EXTERNAL WORKS
AT VLEIFONTEIN, VHEMBE DISTRICT**

Bolts to columns, beams, etc

5	Grade 8.8 precision bolts	t	0.002
6	M20 x 300mm Chemset J- bolt cast into concrete	No	16
7	M12 x 100mm Expansion bolt	No	16

**MILD STEEL BOLTED PURLINS, GIRTS,
BRACING, ETC**

Purlins and girts, plates, etc, welded/bolted to steel

8	350 x 350 x 10mm Thick Baseplate, four times holed and welded to Hollow Section column, and bolted to concrete base with J-bolts (elsewhere measured)	No	17
---	---	----	----

STEEL TRUSSES ETC

**"Mitek Pamir" or similar and approved by the
Principal Agent Ultra-Span light gauge steel roof
trusses in accordance with part "A" and "L" of the
National Building Regulations.**

Hoisting into position exceeding 3.0m

9	Roof construction to double pitched roof supplied and erected complete in position with the following specifications; top chord dead load of 0.100kN/m ² , bottom chord dead load 0.140kN/m ² , wind terrain category C, wind speed of 36m/s, wind pressure 0.436N/m ² , default pitch 5 degrees, etc. Trusses to be at 1400mm centres, battens at 1000mm centres and overhangs at 600mm. Approximately 751m ² on plan. Roof construction to also include galvanised fascias and badge boards and all roof accessories (Refer to Architect's drawings at the back of these Bills of Quantities)		Item
---	---	--	------

Carried to Collection

R

Section No. 2
Bill No 9 - Structural Steel

LDPW-B/20151 - BILLS OF QUANTITIES

**CONSTRUCTION OF NEW LIBRARY
INCLUDING ELECTRICAL, MECHANICAL INSTALLATION
AND ASSOCIATED EXTERNAL WORKS
AT VLEIFONTEIN, VHEMBE DISTRICT**

PAINTWORK, ETC.

ON METAL

Spot primer defects in pre-primed surfaces with zinc chromate primer, one universal undercoat and two coats "Plascon" or equal and approved enamel paint

10	On structural steelwork	m2	8		
----	-------------------------	----	---	--	--

Carried to Collection

R

Section No. 2
Bill No 9 - Structural Steel
LDPW-B/20151 - BILLS OF QUANTITIES

**CONSTRUCTION OF NEW LIBRARY
INCLUDING ELECTRICAL, MECHANICAL INSTALLATION
AND ASSOCIATED EXTERNAL WORKS
AT VLEIFONTEIN, VHEMBE DISTRICT**

Section No. 2

Bill No. 9

Bill No 9 - Structural Steel

COLLECTION

Total Brought Forward from Page No.

**Page
No**

239

Amount

Total Brought Forward from Page No.

240

Total Brought Forward from Page No.

241

Total Brought Forward from Page No.

242

Carried Forward to Summary of Section No. 2

R

Section No. 2

Bill No 9 - Structural Steel

LDPW-B/20151 - BILLS OF QUANTITIES

**CONSTRUCTION OF NEW LIBRARY
INCLUDING ELECTRICAL, MECHANICAL INSTALLATION
AND ASSOCIATED EXTERNAL WORKS
AT VLEIFONTEIN, VHEMBE DISTRICT**

Item No		Quantity	Rate	Amount
	<u>BILL NO. 12</u>			
	<u>METALWORK</u>			
	<u>(WORK GROUP 136)</u>			
	<u>PREAMBLES</u> For preambles refer to <u>"Department of Public Works: Specification of Materials and Method to be used - PW371"</u>			
	<u>NOTE</u>			
	All prices/rates to be net, excluding Value Added Tax			
	<u>SUPPLEMENTARY PREAMBLES</u>			
	<u>Descriptions</u>			
	Descriptions of expansion anchors and bolts shall be deemed to include nuts, washers and mortices in brickwork or concrete			
	Metalwork described as "holed for bolt(s)" shall be deemed to exclude the bolts unless otherwise described			
	Burglar bars to windows			
	All opening sections shall be filled with burglar bars, unless otherwise described			
	Glazing beads to windows			
	Guarantees for glass shall be provided upon completion of the works.			
	Tendered rates must make provision for the above-mentioned as no additional claims in this regards will afterwards be entertained			
	Carried to Collection			R
	Section No. 2 Bill No 10 - Metalwork LDPW-B/20151 - BILLS OF QUANTITIES			

**CONSTRUCTION OF NEW LIBRARY
INCLUDING ELECTRICAL, MECHANICAL INSTALLATION
AND ASSOCIATED EXTERNAL WORKS
AT VLEIFONTEIN, VHEMBE DISTRICT**

Gates to external doors

1	Single gate 970 x 2125mm high overall comprising of 50 x 75mm galvanised rectangular steel tubular frame with 50 x 5mm thick plate welded onto the inside of the frame and bolted with M10 to brickwork, "Steeldale Bestfence" or similar and approved by the Principal Agent galvanised mesh "BRC Thru Fencing No. 917", with 12.7 x 76.2mm aperture and 4mm thick wire diameter in flush cut sheets of 440 x 1480mm welded to opening section of the gate. G01.	No	3
2	Screen 2800 x 1800mm high overall comprising of 50 x 75mm galvanised rectangular steel tubular frame with 50 x 5mm thick plate welded onto the inside of the frame and bolted with M10 to brickwork, "Steeldale Bestfence" or similar and approved by the Principal Agent galvanised mesh "BRC Thru Fencing No. 917", with 12.7 x 76.2mm aperture and 4mm thick wire diameter in flush cut sheets of 1200 x 2400mm welded to opening section of the gate. L01.	No	2
3	Screen 3000 x 1200mm high overall comprising of 50 x 75mm galvanised rectangular steel tubular frame with 50 x 5mm thick plate welded onto the inside of the frame and bolted with M10 to brickwork, "Steeldale Bestfence" or similar and approved by the Principal Agent galvanised mesh "BRC Thru Fencing No. 917", with 12.7 x 76.2mm aperture and 4mm thick wire diameter in flush cut sheets of 1200 x 2400mm welded to opening section of the gate. L01.	No	1
4	Screen 400 x 4400mm high overall comprising of 50 x 75mm galvanised rectangular steel tubular frame with 50 x 5mm thick plate welded onto the inside of the frame and bolted with M10 to brickwork, "Steeldale Bestfence" or similar and approved by the Principal Agent galvanised mesh "BRC Thru Fencing No. 917", with 12.7 x 76.2mm aperture and 4mm thick wire diameter in flush cut sheets of 440 x 1330mm welded to opening section of the gate. L01.	No	10

Carried to Collection

R

Section No. 2

Bill No 10 - Metalwork

LDPW-B/20151 - BILLS OF QUANTITIES

**CONSTRUCTION OF NEW LIBRARY
INCLUDING ELECTRICAL, MECHANICAL INSTALLATION
AND ASSOCIATED EXTERNAL WORKS
AT VLEIFONTEIN, VHEMBE DISTRICT**

**GALVANISED MILD STEEL DOOR FRAMES,
INCLUDING BUILDING INTO BRICKWORK**

**1,6mm Thick single rebated primed steel door
frames supplied with chromium plated strike plates
suitable for half brick walls**

5	Frame for door size 813mm x 2032mm high, D01	No	9
6	Frame for door size 889mm x 2032mm high, D03	No	1

**1,2mm Thick single rebated primed steel door
frames supplied with chromium plated strike plates
suitable for one brick walls**

7	Frame for door size 813mm x 2032mm high, D01	No	5
8	Frame for door size 1696mm x 2032mm high, D02	No	1
9	Frame for door size 826mm x 2063mm high D04	No	1
10	Frame for door size 889mm x 2068mm high D05	No	1
11	Frame for door size 989mm x 2068mm high D06	No	1

**ALUMINIUM WINDOWS. ETC.. INCLUDING
BUILDING INTO BRICKWORK**

NOTE: Indicative window schedules are attached at the end of the bills of quantities to assist the tenderer in pricing

Rates for the following aluminium windows are to include for supplying and building in of temporary templates

Design, supply, deliver to site and install the following windows/shopfront in accordance with the manufacturers instructions

Carried to Collection

R

Section No. 2
Bill No 10 - Metalwork
LDPW-B/20151 - BILLS OF QUANTITIES

**CONSTRUCTION OF NEW LIBRARY
INCLUDING ELECTRICAL, MECHANICAL INSTALLATION
AND ASSOCIATED EXTERNAL WORKS
AT VLEIFONTEIN, VHEMBE DISTRICT**

Polyester powder coated aluminium framed windows/shopfront glazed as described, including all necessary framing, transomes, mullions, beads, clips, etc., all ironmongery comprising hinges, friction stays, wedgeless handles, external sealing between gaskets, external sealant between framing and adjoining structure with an approved sealant recommended for the purpose intended, all fixings and supports protection from all damage, cleaning down upon completion and everything necessary for a perfectly weather tight installation to the intent, approval and satisfaction of the Architect. NOTE : All windows to be fitted complete with 12 x 12mm Aluminium square bars @ 150mm centres maximum and rates will be deemed to include such

Windows/shopfront glazed with 6.38mm thick PVB faidbrand laminated safety glass and plugged to brickwork

12	Purpose made window size 600 x 900mm high W1	No	6
13	Purpose made window size 440 x 3570mm high AL01	No	8
14	Purpose made window size 3456 x 680mm high AL02	No	7
15	Purpose made window size 3315 x 1615mm high AL04	No	1
16	Purpose made window size 4278 x 425mm high. AL06	No	1
17	Purpose made window size 3390 x 2465mm high AL07	No	1
18	Purpose made window size 3643 x 425mm high AL08	No	1
19	Purpose made window size 2285 x 2465mm high AL09	No	1
20	Purpose made window size 3036 x 1445mm high AL11	No	1
21	Purpose made window size 1100 x 3740mm high AL14	No	2
22	Purpose made window size 2148 x 1530mm high AL18	No	1
23	Purpose made window size 4500 x 1530mm high AL19	No	1

Carried to Collection

R

Section No. 2

Bill No 10 - Metalwork

LDPW-B/20151 - BILLS OF QUANTITIES

**CONSTRUCTION OF NEW LIBRARY
INCLUDING ELECTRICAL, MECHANICAL INSTALLATION
AND ASSOCIATED EXTERNAL WORKS
AT VLEIFONTEIN, VHEMBE DISTRICT**

24	Purpose made window size 2958 x 2465mm high AL21	No	1	
25	Purpose made window size 4787 x 1530mm high AL23	No	1	
26	Purpose made window size 3770 x 1105mm high AL24	No	1	
27	Purpose made window size 2429 x 1105mm high AL25	No	1	
28	Purpose made window size 3100 x 1105mm high AL26	No	1	
29	Purpose made window size 4685 x 425mm high AL27	No	1	
30	Purpose made window size 440 x 2465mm high AL28	No	3	
31	Purpose made window size 5685 x 1072mm high AL30	No	1	
Carried to Collection				
Section No. 2				
Bill No 10 - Metalwork				
LDPW-B/20151 - BILLS OF QUANTITIES				
				R

**CONSTRUCTION OF NEW LIBRARY
INCLUDING ELECTRICAL, MECHANICAL INSTALLATION
AND ASSOCIATED EXTERNAL WORKS
AT VLEIFONTEIN, VHEMBE DISTRICT**

**ALUMINIUM DOORS, ETC.. INCLUDING
BUILDING INTO BRICKWORK**

Polyester coated aluminium framed windows/shopfront glazed as described, including all necessary framing, transomes, mullions, beads, clips, etc., all ironmongery comprising hinges, friction stays, wedgeless handles, external sealing between gaskets, external sealant between framing and adjoining structure with an approved sealant recommended for the purpose intended, all fixings and supports protection from all damage, cleaning down upon completion and everything necessary for a perfectly weather tight installation to the intent, approval and satisfaction of the Architect. NOTE : All doors to be fitted complete with "Trellidor" for the entire area and rates will be deemed to include such

Door and sidelights glazed with 6mm thick PVB faidbrand laminated safety glass and plugged to brickwork

Shopfront

32	Epoxy powder coated aluminium frame, 115 x 40mm (4253 x 2465mm high overall) Clip 44 shopfront with single swing 1800 x 2465 double doors, with 8,38mm Laminated safety glass. AL03	No	1.00
33	Epoxy powder coated aluminium frame, 115 x 40mm (4390 x 2465mm high overall) Clip 44 shopfront with single swing 1763 x 2465 double doors, with 8,38mm Laminated safety glass. AL05	No	1.00
34	Epoxy powder coated aluminium frame, 115 x 40mm (1045 x 2465mm high overall) Clip 44 shopfront with single swing 1045 x 2465 single doors, with 8,38mm Laminated safety glass. AL10	No	1.00

Carried to Collection

R

Section No. 2
Bill No 10 - Metalwork

LDPW-B/20151 - BILLS OF QUANTITIES

**CONSTRUCTION OF NEW LIBRARY
INCLUDING ELECTRICAL, MECHANICAL INSTALLATION
AND ASSOCIATED EXTERNAL WORKS
AT VLEIFONTEIN, VHEMBE DISTRICT**

35	Epoxy powder coated aluminium frame, 115 x 40mm (1876 x 2465mm high overall) Clip 44 shopfront with double swing 1876 x 2465 double doors, with 8,38mm Laminated safety glass below and 6,38mm Laminated safety glass above, 1876 x 650mm fanlight glazed with 6,38mm Laminated safety glass. AL12	No	1.00
36	Epoxy powder coated aluminium frame, 115 x 40mm (2812 x 3740mm high overall) Clip 44 shopfront with double swing 1800 x 2400 double doors, with 8,38mm Laminated safety glass below and 6,38mm Laminated safety glass above, 2812 x 1340mm fanlight glazed with 6,38mm Laminated safety glass. AL13	No	1.00
37	Epoxy powder coated aluminium frame, 115 x 40mm (3947 x 2890mm high overall) Clip 44 shopfront with double swing 1800 x 2400 double doors, with 8,38mm Laminated safety glass below and 6,38mm Laminated safety glass above, 3947 x 490mm fanlight glazed with 6,38mm Laminated safety glass. AL15	No	1.00
38	Epoxy powder coated aluminium frame, 115 x 40mm (1200 x 2465mm high overall) Clip 44 shopfront with single swing 950 x 2465 single doors, with 8,38mm Laminated safety glass. AL16	No	1.00
39	Epoxy powder coated aluminium frame, 115 x 40mm (1317 x 2465mm high overall) Clip 44 shopfront with single swing 950 x 2465 single doors, with 8,38mm Laminated safety glass. AL17	No	1.00
40	Epoxy powder coated aluminium frame, 115 x 40mm (3810 x 2465mm high overall) Clip 44 shopfront with single swing 980 x 2465 single doors, with 8,38mm Laminated safety glass. AL20	No	1.00
41	Epoxy powder coated aluminium frame, 115 x 40mm (1997 x 2465mm high overall) Clip 44 shopfront with single swing 999 x 2465 single doors, with 8,38mm Laminated safety glass. AL22	No	1.00

Carried to Collection

R

Section No. 2
Bill No 10 - Metalwork

**CONSTRUCTION OF NEW LIBRARY
INCLUDING ELECTRICAL, MECHANICAL INSTALLATION
AND ASSOCIATED EXTERNAL WORKS
AT VLEIFONTEIN, VHEMBE DISTRICT**

LDPW-B/20151 - BILLS OF QUANTITIES

--	--	--	--	--

**CONSTRUCTION OF NEW LIBRARY
INCLUDING ELECTRICAL, MECHANICAL INSTALLATION
AND ASSOCIATED EXTERNAL WORKS
AT VLEIFONTEIN, VHEMBE DISTRICT**

42	Epoxy powder coated aluminium frame, 115 x 40mm Clip 44 shopfront with single swing 2075 x 2465 double doors, with 8,38mm Laminated safety glass. AL29	No	1.00		
<u>ROLLER SHUTTER DOORS</u>					
<u>"Xpanda" or any other of similar quality approved by the Principal Agent, chain operated installed to manufacturer's specification.</u>					
43	Roller shutter door with stainless steel frame suitable for opening size 4500 x 2800m high with 500mm headroom, 130mm clearance on free side, 315mm clearance on operator side, 75mm wide x 1mm thick slate, 75mm wide side guides, "Xpanda Rol-Lok" or similar quality and approved by the Principal Agent locking mechanism complete with two keys, pressed steel canopy cover and weather strip T-bar to bottom edge, perimeter framing plugged and screwed to face at maximum 300mm centres to concrete and brickwork . D07	No	2		
44	Roller shutter door with stainless steel frame suitable for opening size 3500 x 2500m high with 500mm headroom, 130mm clearance on free side, 315mm clearance on operator side, 75mm wide x 1mm thick slate, 75mm wide side guides, "Xpanda Rol-Lok" or similar quality and approved by the Principal Agent locking mechanism complete with two keys, pressed steel canopy cover and weather strip T-bar to bottom edge, perimeter framing plugged and screwed to face at maximum 300mm centres to concrete and brickwork . D08	No	1		
Carried to Collection					
Section No. 2 Bill No 10 - Metalwork LDPW-B/20151 - BILLS OF QUANTITIES					
					R

**CONSTRUCTION OF NEW LIBRARY
INCLUDING ELECTRICAL, MECHANICAL INSTALLATION
AND ASSOCIATED EXTERNAL WORKS
AT VLEIFONTEIN, VHEMBE DISTRICT**

**STEEL STRONGROOM DOORS,
VENTILATORS. ETC**

**"Austen" or similar and approved by the Principal
Agent record room doors etc suitable for 220mm
walls fixed to brickwork or concrete**

45	"CAT 1 SABS 949" strongroom door and frame 1030 x 2010mm high overall with a mass of 321kg, including one 7 lever security lock and wall mounted doorstop	No	1
46	Double ended strongroom ventilator	No	2

Carried to Collection

R

Section No. 2
Bill No 10 - Metalwork
LDPW-B/20151 - BILLS OF QUANTITIES

**CONSTRUCTION OF NEW LIBRARY
INCLUDING ELECTRICAL, MECHANICAL INSTALLATION
AND ASSOCIATED EXTERNAL WORKS
AT VLEIFONTEIN, VHEMBE DISTRICT**

Section No. 2

Bill No. 10

Bill No 10 - Metalwork

COLLECTION

Total Brought Forward from Page No.

**Page
No**

244

Amount

Total Brought Forward from Page No.

245

Total Brought Forward from Page No.

246

Total Brought Forward from Page No.

247

Total Brought Forward from Page No.

248

Total Brought Forward from Page No.

249

Total Brought Forward from Page No.

250

Total Brought Forward from Page No.

251

Total Brought Forward from Page No.

252

Carried Forward to Summary of Section No. 2

R

Section No. 2

Bill No 10 - Metalwork

LDPW-B/20151 - BILLS OF QUANTITIES

**CONSTRUCTION OF NEW LIBRARY
INCLUDING ELECTRICAL, MECHANICAL INSTALLATION
AND ASSOCIATED EXTERNAL WORKS
AT VLEIFONTEIN, VHEMBE DISTRICT**

Item No		Quantity	Rate	Amount
	<p><u>BILL NO. 13</u></p> <p><u>PLASTERING</u></p> <p><u>(WORK GROUP 142)</u></p> <p><u>PREAMBLES</u>For preambles refer to <u>"Department of Public Works: Specification of Materials and Method to be used - PW371"</u></p> <p><u>NOTE</u></p> <p>All prices/rates to be net, excluding Value Added Tax</p> <p><u>SUPPLEMENTARY PREAMBLES</u></p> <p>Textured finishes</p> <p>All textured finishes are to be applied to the satisfaction of the Principal Agent and executed by an approved firm of Specialists, all strictly in accordance with the materials supplied and methods employed by the Manufacturer</p> <p>Preparatory work for textured finishes</p> <p>Textured finishes to be applied to surfaces as described. Rates tendered are to include for all necessary priming, preparatory work, etc.</p> <p>All surfaces are to be inspected and approved by the Principal Agent prior to any work is commenced with</p>			
	Carried to Collection		R	
	<p>Section No. 2 Bill No 11 - Plastering LDPW-B/20151 - BILLS OF QUANTITIES</p>			

**CONSTRUCTION OF NEW LIBRARY
INCLUDING ELECTRICAL, MECHANICAL INSTALLATION
AND ASSOCIATED EXTERNAL WORKS
AT VLEIFONTEIN, VHEMBE DISTRICT**

SCREEDS

3:1 Cement plaster screeds steel trowelled on concrete

1	25mm Thick on concrete floors to receive tiles	m2	614
2	25mm Thick on concrete floors to receive epoxy	m2	55

INTERNAL PLASTER

One coat (1:5) cement plaster on brickwork

3	On walls	m2	1 482
4	On narrow widths	m2	50

DIVIDING STRIPS, COVER STRIPS ETC

Strips

5	3 x 25mm Brass dividing strip with top flush with floor finish	m	17
---	--	---	----

"Joint Master " or similar approved

6	Expansion joint seal series 800 Code 806- floor-floor cover strip	m	15
---	---	---	----

SPECIALIST FINISH TO WALLS AND FLOORS

EPOXY TO FLOORS

4mm Thick "Sika" or similar and approved by the Principal Agent seamless slip resistant floor finish epoxy as per Manufacturers specification

7	On floors	m2	55
---	-----------	----	----

Carried to Collection

R

Section No. 2
Bill No 11 - Plastering

***CONSTRUCTION OF NEW LIBRARY
INCLUDING ELECTRICAL, MECHANICAL INSTALLATION
AND ASSOCIATED EXTERNAL WORKS
AT VLEIFONTEIN, VHEMBE DISTRICT***

LDPW-B/20151 - BILLS OF QUANTITIES

**CONSTRUCTION OF NEW LIBRARY
INCLUDING ELECTRICAL, MECHANICAL INSTALLATION
AND ASSOCIATED EXTERNAL WORKS
AT VLEIFONTEIN, VHEMBE DISTRICT**

Section No. 2

Bill No. 11

Bill No 11 - Plastering

COLLECTION

Total Brought Forward from Page No.

Total Brought Forward from Page No.

**Page
No**

254

255

Amount

Carried Forward to Summary of Section No. 2

R

Section No. 2

Bill No 11 - Plastering

LDPW-B/20151 - BILLS OF QUANTITIES

**CONSTRUCTION OF NEW LIBRARY
INCLUDING ELECTRICAL, MECHANICAL INSTALLATION
AND ASSOCIATED EXTERNAL WORKS
AT VLEIFONTEIN, VHEMBE DISTRICT**

Item No		Quantity	Rate	Amount
	<p><u>BILL NO. 14</u></p> <p><u>TILING</u></p> <p><u>(WORK GROUP 144)</u></p> <p><u>PREAMBLES</u>For preambles refer to <u>"Department of Public Works: Specification of Materials and Method to be used - PW371"</u></p> <p><u>NOTE</u></p> <p>All prices/rates to be net, excluding Value Added Tax</p> <p><u>SUPPLEMENTARY PREAMBLES</u></p> <p>Prices</p> <p>Prices are to include for all square cutting and waste, cleaning off on completion and protection from injury. Areas are measured net to face of bare brickwork and concrete</p>			
	Carried to Collection		R	
	<p>Section No. 2 Bill No 12 - Tiling LDPW-B/20151 - BILLS OF QUANTITIES</p>			

**CONSTRUCTION OF NEW LIBRARY
INCLUDING ELECTRICAL, MECHANICAL INSTALLATION
AND ASSOCIATED EXTERNAL WORKS
AT VLEIFONTEIN, VHEMBE DISTRICT**

WALL TILING

200 x 200 x 5mm "Tal Gold" or similar and approved by the Principal Agent ceramic wall tiles fixed with adhesive to plaster (plaster elsewhere measured) and flush pointed with tinted jointing compound in diagonal or rectangular dado tile pattern

1	On walls	m2	370
---	----------	----	-----

PORCELAIN FLOOR TILES

600mm x 600mm x 8.5mm Thick "Tal Gold" or similar and approved by the Principal Agent polished porcelain floor tile with 3mm joints complete with rectangular borders and diagonal infill panels, install with tile adhesive as recommended by tile manufacturer on well-prepared screed to suit required level. Finish all joints with CORPROX waterproof grout. All strictly to manufacturer's specifications. Colour and type and detail pattern design to Architect's approval.

2	On floors	m2	614
---	-----------	----	-----

3	Cut tile skirting 150 mm high with and including approved 10mm "Genesis" or similar approved aluminium trims	m	494
---	--	---	-----

4	Border tile of cut 150mm high with and including 2 x 10mm "Genesis" or approved aluminium strips	m	32
---	--	---	----

5	10mm "Genesis" or approved aluminium strips to corners of windows and walls	m	70
---	---	---	----

Carried to Collection

R

Section No. 2
Bill No 12 - Tiling

**CONSTRUCTION OF NEW LIBRARY
INCLUDING ELECTRICAL, MECHANICAL INSTALLATION
AND ASSOCIATED EXTERNAL WORKS
AT VLEIFONTEIN, VHEMBE DISTRICT**

LDPW-B/20151 - BILLS OF QUANTITIES

--	--	--	--	--

**CONSTRUCTION OF NEW LIBRARY
INCLUDING ELECTRICAL, MECHANICAL INSTALLATION
AND ASSOCIATED EXTERNAL WORKS
AT VLEIFONTEIN, VHEMBE DISTRICT**

Section No. 2

Bill No. 12

Bill No 12 - Tiling

COLLECTION

Total Brought Forward from Page No.

Total Brought Forward from Page No.

**Page
No**

257

258

Amount

Carried Forward to Summary of Section No. 2

R

Section No. 2

Bill No 12 - Tiling

LDPW-B/20151 - BILLS OF QUANTITIES

**CONSTRUCTION OF NEW LIBRARY
INCLUDING ELECTRICAL, MECHANICAL INSTALLATION
AND ASSOCIATED EXTERNAL WORKS
AT VLEIFONTEIN, VHEMBE DISTRICT**

Item No		Quantity	Rate	Amount
	<p><u>BILL NO. 15</u></p> <p><u>PLUMBING AND DRAINAGE</u> <u>(PROVISIONAL)</u></p> <p><u>(WORK GROUP 148)</u></p> <p><u>PREAMBLES</u>For preambles refer to <u>"Department of Public Works: Specification of</u> <u>Materials and Method to be used - PW371"</u></p> <p><u>NOTE</u></p> <p>All prices/rates to be net, excluding Value Added Tax</p> <p><u>SUPPLEMENTARY PREAMBLES</u></p> <p>Excavations</p> <p>Prices for excavations must include for necessary staging for risk of collapse of excavation side.</p> <p>Compacting</p> <p>Filling for all types of prices described as "under solid floors, etc" shall be done with approved backfilling and compacted to 93% Mod. AASHTO density, unless otherwise described</p> <p>Testing</p> <p>Descriptions for the testing of plumbing and drainage installations shall be deemed to cater for all testing apparatus, labour, etc. and shall be done strictly as directed by and in accordance to the Principal Agent's instructions, including for retesting after taking out and making good all defective work to his entire satisfaction</p>			
	Carried to Collection		R	
	<p>Section No. 2 Bill No 13 - Plumbing and drainage LDPW-B/20151 - BILLS OF QUANTITIES</p>			

**CONSTRUCTION OF NEW LIBRARY
INCLUDING ELECTRICAL, MECHANICAL INSTALLATION
AND ASSOCIATED EXTERNAL WORKS
AT VLEIFONTEIN, VHEMBE DISTRICT**

Vitrified clay pipes:

Pipes shall rest on solid ground and, where necessary, pockets of sufficient size shall be cut around joints to enable the jointing to be properly performed or, alternatively, pipes shall be bedded full length on and including unreinforced concrete laid in a semi-dry state immediately before pipes are laid

Sewer and drainage pipes and fittings shall be jointed and sealed with butyl rubber rings

uPVC pipes and fittings

Sewer and drainage pipes and fittings shall be jointed and sealed with butyl rubber rings

Soil, waste and vent pipe fittings shall be solvent weld jointed

uPVC pressure pipes and fittings

Pipes for water supply shall be of the class stated

Pipes of 40mm diameter and smaller shall be plain ended with solvent welded uPVC loose sockets and fittings

Copper pipes

Pipes shall be hard drawn and half hard pipes of the class stated. Class 0 (thin walled hard drawn pipes) shall not be bent. Class 1 (thin half hard), Class 2 (half hard) and Class 3 (heavy walled half-hard) pipes shall only be bent with benders with inner and outer formers. Fittings to copper waste, vent and anti siphon pipes, capillary solder fittings and compression fittings shall be "Cobra Watertech" type. Capillary solder fittings shall comply with ISO 2016. Only compression fittings shall be used in walls or ground.

Carried to Collection

Section No. 2
Bill No 13 - Plumbing and drainage
LDPW-B/20151 - BILLS OF QUANTITIES

R

**CONSTRUCTION OF NEW LIBRARY
INCLUDING ELECTRICAL, MECHANICAL INSTALLATION
AND ASSOCIATED EXTERNAL WORKS
AT VLEIFONTEIN, VHEMBE DISTRICT**

Reducing fittings

Where fittings have reducing ends or branches they are described as "reducing". In the case of pipes with diameters not exceeding 60mm only the largest end or branch size is given. Should the Contractor wish to use other fittings and bushes or reducers, he may do so on the understanding that no claim in this regard will be entertained. In the case of pipes with diameters exceeding 60mm all sizes are given and no claim for extra bushes, reducers will be entertained.

Excavations

No claim for extra rock excavation will be entertained unless the Contractor has timeously notified the Quantity Surveyor, thereof prior to backfilling, in writing

"Soft rock" and "Hard rock" shall be as defined in "Earthworks"

Laying, Backfilling, Bedding, etc. of Pipes

Pipes shall be laid and bedded and trenches shall be carefully backfilled in accordance with the manufacturer's instructions

Where no manufacturer's instructions exist pipes shall be laid in accordance with clauses 5.1 and 5.2 of each of the following: SABS 1200L : Medium Pressure Pipes
LD : Sewers LE : Stormwater Drainage

Pipes trenches, etc. shall be backfilled in accordance with Clauses 3, 5.5, 5.6, 5.7 and 7 of SABS 1200DB: Earthworks (Pipe Trenches)

Pipes shall be bedded in accordance with Clause 3.1 to 3.4.1, 5.1 to 5.3 and 7 of SABS 1200LB : Bedding (Pipes)

Unless otherwise described bedding of rigid pipes shall be Class B bedding

Carried to Collection

Section No. 2
Bill No 13 - Plumbing and drainage
LDPW-B/20151 - BILLS OF QUANTITIES

R

**CONSTRUCTION OF NEW LIBRARY
INCLUDING ELECTRICAL, MECHANICAL INSTALLATION
AND ASSOCIATED EXTERNAL WORKS
AT VLEIFONTEIN, VHEMBE DISTRICT**

Flush pans

Flush pans shall have straight or side outlets and "P" or "S" traps as necessary

Waste unions

Description of waste unions shall be deemed to include rubber or vulcanite plugs and chains

DRAINAGE

NOTE: All items in this section shall be deemed to fall into Work Group No 146 for Haylett formula purposes

SOIL DRAINAGE

Unless otherwise stated herein, all items in this section shall be deemed to fall into Work Group No 146 for Haylett formula purposes.

Carried to Collection

Section No. 2
Bill No 13 - Plumbing and drainage
LDPW-B/20151 - BILLS OF QUANTITIES

R

**CONSTRUCTION OF NEW LIBRARY
INCLUDING ELECTRICAL, MECHANICAL INSTALLATION
AND ASSOCIATED EXTERNAL WORKS
AT VLEIFONTEIN, VHEMBE DISTRICT**

RAINWATER DISPOSAL

Approved 0.8mm galvanised sheet iron with
"Chromadek" finish, in:

1	150 x 125mm Eaves gutter	m	145
2	Extra over last for stopped end	No	18
3	Ditto, but for outlet for 100mm diameter pipe	No	13
4	75mm Diameter rainwater downpipe fixed to wall	m	39
5	Extra over last for eaves or plinth offset	No	6
6	Ditto, but for shoe	No	13

SANITARY PLUMBING

uPVC pipes

7	50mm Pipes fixed to walls	m	19
8	50mm Pipes laid under slabs and including trenches not exceeding 1m deep	m	19
9	110mm Pipes fixed to walls or soffits	m	8
10	110mm Pipes laid under surface beds and including trenches not exceeding 1m deep	m	9
11	110mm Pipe encased in concrete 20MPa/20 under surface beds and including excavation exceeding 1m and not exceeding 2m deep	m	8

Extra over upvc pipes for fittings

12	50mm Bend	No	14
13	50mm Access bend	No	11
14	50mm Access junction	No	4

Carried to Collection

R

Section No. 2
Bill No 13 - Plumbing and drainage
LDPW-B/20151 - BILLS OF QUANTITIES

**CONSTRUCTION OF NEW LIBRARY
INCLUDING ELECTRICAL, MECHANICAL INSTALLATION
AND ASSOCIATED EXTERNAL WORKS
AT VLEIFONTEIN, VHEMBE DISTRICT**

15	50mm Junction	No	2	
16	110 x 50mm Reducer	No	5	
17	110mm Plain bend	No	7	
18	110mm Access bend	No	6	
19	110mm Access junction	No	3	
20	110mm Pan connector	No	6	
21	110mm Bent pan connector	No	1	
22	110mm Two way vent valve	No	4	
<u>SANITARY FITTINGS</u>				
<u>"Franke" or similar and approved by the Principal Agent Stainless steel grade 304 (18/10)</u>				
23	Stainless steel kitchen sink Code: 310332	No	2	
<u>"Vaal Potteries" or other equal and approved by the Principal Agent</u>				
24	"Vaal" 510 x 405mm semi rectangular "daisy" wash hand basin with single semi-punched taphole, integrated overflow and chainstay hole including fixing to wall and all accessories complete (code 7023)	No	6	
25	Vaal "Cameo" 595 x 455mm oval self rimming vanity basin with one semi punched taphole wash hand basin with single semi-punched taphole, integrated overflow and chainstay hole including fixing to wall and all accessories complete (code 7023)	No	1	
26	Aquasave vitreous china habiscus close coupled 90 degrees outlet open rim washdown pan as 772610 with solid hard plastic toilet seat and lid , 9 litre cistern as 710531 with chrome plated front -flush lever mounted to cistern	No	6	
Carried to Collection				R
Section No. 2				
Bill No 13 - Plumbing and drainage				
LDPW-B/20151 - BILLS OF QUANTITIES				

**CONSTRUCTION OF NEW LIBRARY
INCLUDING ELECTRICAL, MECHANICAL INSTALLATION
AND ASSOCIATED EXTERNAL WORKS
AT VLEIFONTEIN, VHEMBE DISTRICT**

27	"Vaal" vitreous china Protea Paraplegic suite Code 750246, 90 degrees outlet pan Code 750200 and matching 9 litre cistern Code 710631 complete with lid, fitments and purpose made CP side flush lever (left or right) or a back inlet exposed flushvalves 750151 with solid hard plastic toilet seat and lid as Al de Lux (SABS CKS 301)	No	1		
28	Lavetera 385 x 380 x 600mm vitreous china wall mounted urinal with top inlet (Code 704001), overall size 600 x 385 x 380mm. supplied with 38mm chrome plated domical grating (Code 8787),and chromium plated spreader (Code 7041Z0),and including flush master junior FJ6000 complete with all fittings.	No	2		
<u>WASTE UNION</u>					
<u>"Cobra Watertech" or other equal and approved</u>					
29	32mm 301CP waste union	No	9		
30	38mm 316CP Sink waste union	No	1		
<u>TRAPS, ETC</u>					
<u>"Cobra Watertech" or other equal and approved</u>					
31	38mm Chromium plated bottle trap	No	9		
<u>"Rubber"</u>					
32	40mm Deep seal "P" or "S" trap	No	7		
Carried to Collection					
				R	
Section No. 2 Bill No 13 - Plumbing and drainage LDPW-B/20151 - BILLS OF QUANTITIES					

**CONSTRUCTION OF NEW LIBRARY
INCLUDING ELECTRICAL, MECHANICAL INSTALLATION
AND ASSOCIATED EXTERNAL WORKS
AT VLEIFONTEIN, VHEMBE DISTRICT**

TAPS, VALVES, ETC

"Brass"

33	15mm Stopcock	No	16	
----	---------------	----	----	--

**"Sandria" or other equal and approved by the
Principal Agent**

34	15mm "Sandria" sink mixer code 3008/13SCCH chromium plated	No	2	
----	---	----	---	--

**"Franke" or other equal and approved by the
Principal Agent**

35	15 mm Basin mixer Code No. TVID0250	No	2	
----	-------------------------------------	----	---	--

36	15 mm Elbow action pillar tap	No	5	
----	-------------------------------	----	---	--

Valves, control valves etc., fixed to copper pipes

**"Cobra Watertech" or other equal and approved by
the Principal Agent**

37	22mm Cast brass fullway gate valve	No	6	
----	------------------------------------	----	---	--

38	28mm Cast brass fullway gate valve	No	2	
----	------------------------------------	----	---	--

Testing

39	Allow for testing the whole of the sanitary plumbing installation to the approval of the Representative/Agent		Item	
----	--	--	------	--

Carried to Collection

R

Section No. 2
Bill No 13 - Plumbing and drainage

LDPW-B/20151 - BILLS OF QUANTITIES

**CONSTRUCTION OF NEW LIBRARY
INCLUDING ELECTRICAL, MECHANICAL INSTALLATION
AND ASSOCIATED EXTERNAL WORKS
AT VLEIFONTEIN, VHEMBE DISTRICT**

WATER SUPPLY

Class O thin wall hard drawn copper pipes and fittings with capillary soldered type connections

40	15mm Pipes	m	116
41	22mm Pipes	m	70
42	28mm Pipes	m	40

Extra over class O copper fittings for soldered capillary fittings

43	15mm Fitting	No	32
44	22mm Fitting	No	16
45	15mm Service pipe 350mm girth	No	20

Extra over 28mm diameter copper piping for soldered capillary fittings

46	Bend or elbow	No	14
47	Tee	No	6

FIRE APPLIANCES ETC.

48	Fire hose reel complete with 30m x 20m diameter hose, including reel, valve, nozzle and wall bracket bolted on	No	1
49	9Kg Dry chemical fire extinguisher	No	11

WATER SUPPLY TO FIRE APPLIANCES

Galvanised steel pipes

50	25mm Pipes	m	30
----	------------	---	----

Carried to Collection

R

Section No. 2
Bill No 13 - Plumbing and drainage
LDPW-B/20151 - BILLS OF QUANTITIES

**CONSTRUCTION OF NEW LIBRARY
INCLUDING ELECTRICAL, MECHANICAL INSTALLATION
AND ASSOCIATED EXTERNAL WORKS
AT VLEIFONTEIN, VHEMBE DISTRICT**

<u>Extra over galvanised steel pipes for steel fittings</u>			
51	25mm Fittings	No	4
<u>VALVES TO FIRE APPLIANCES</u>			
<u>"Cobra watertech" or other equal and approved</u>			
52	25mm 1001/125-25 PRESTEX brass fullway gate valve	No	1
<u>Testing</u>			
53	Allow for testing the whole of the water supplies and fire service installation to the approval of the Representative/ Agent		Item
Carried to Collection			R
Section No. 2 Bill No 13 - Plumbing and drainage			
LDPW-B/20151 - BILLS OF QUANTITIES			

**CONSTRUCTION OF NEW LIBRARY
INCLUDING ELECTRICAL, MECHANICAL INSTALLATION
AND ASSOCIATED EXTERNAL WORKS
AT VLEIFONTEIN, VHEMBE DISTRICT**

Section No. 2

Bill No. 13

Bill No 13 - Plumbing and drainage

COLLECTION

Total Brought Forward from Page No.

**Page
No**

260

Amount

Total Brought Forward from Page No.

261

Total Brought Forward from Page No.

262

Total Brought Forward from Page No.

263

Total Brought Forward from Page No.

264

Total Brought Forward from Page No.

265

Total Brought Forward from Page No.

266

Total Brought Forward from Page No.

267

Total Brought Forward from Page No.

268

Total Brought Forward from Page No.

269

Carried Forward to Summary of Section No. 2

R

Section No. 2

Bill No 13 - Plumbing and drainage

LDPW-B/20151 - BILLS OF QUANTITIES

**CONSTRUCTION OF NEW LIBRARY
INCLUDING ELECTRICAL, MECHANICAL INSTALLATION
AND ASSOCIATED EXTERNAL WORKS
AT VLEIFONTEIN, VHEMBE DISTRICT**

Item No		Quantity	Rate	Amount
	<p><u>BILL NO. 16</u></p> <p><u>GLAZING</u></p> <p><u>(WORK GROUP 150)</u></p> <p><u>PREAMBLES</u>For preambles refer to <u>"Department of Public Works: Specification of Materials and Method to be used - PW371"</u></p> <p><u>NOTE</u></p> <p>All prices/rates to be net, excluding Value Added Tax</p> <p><u>SUPPLEMENTARY PREAMBLES</u></p> <p>Prices</p> <p>Prices are to include for all square cutting and waste, cleaning off on completion and protection from injury. Areas are measured net to face of bare brickwork and concrete</p>			
	<p><u>TOPS, SHELVES, DOORS, MIRRORS, ETC</u></p> <p><u>Mirror manufactured from 18/10 stainless steel with a reflective polished surface, drilled for screw to wall and reinforced with Novopan plates screwed to wall</u></p>			
1	<p>Size 450 x 600 x 6mm Silver floated glass with copper backed fixed with gold plated heads at corners</p>	No	7	
	<p>Carried Forward to Summary of Section No. 2</p>			R
	<p>Section No. 2 Bill No 14 - Glazing LDPW-B/20151 - BILLS OF QUANTITIES</p>			

**CONSTRUCTION OF NEW LIBRARY
INCLUDING ELECTRICAL, MECHANICAL INSTALLATION
AND ASSOCIATED EXTERNAL WORKS
AT VLEIFONTEIN, VHEMBE DISTRICT**

Item No		Quantity	Rate	Amount
	<p><u>BILL NO. 17</u></p> <p><u>PAINTWORK</u></p> <p><u>(WORK GROUP 152)</u></p> <p><u>PREAMBLES</u>For preambles refer to <u>"Department of Public Works: Specification of Materials and Method to be used - PW371"</u></p> <p><u>SUPPLEMENTARY PREAMBLES</u></p> <p>Paint</p> <p>All paint, complete with undercoat, primer, etc., to be used strictly in accordance with the manufacturer's specification. Only paint which bears the described trade names will be permitted on site. No substitution will be allowed</p> <p>Previously painted plastered surfaces</p> <p>Surfaces shall be thoroughly washed down and allowed to dry completely before any paint is applied. Blistered or peeling paint shall be completely removed and cracks shall be opened, filled with a suitable filler and finished smooth</p> <p>Access</p> <p>Rates for painting steelwork, shall include access, for unlimited height</p>			
	Carried to Collection		R	
	<p>Section No. 2 Bill No 15 - Paintwork LDPW-B/20151 - BILLS OF QUANTITIES</p>			

**CONSTRUCTION OF NEW LIBRARY
INCLUDING ELECTRICAL, MECHANICAL INSTALLATION
AND ASSOCIATED EXTERNAL WORKS
AT VLEIFONTEIN, VHEMBE DISTRICT**

PAINTWORK, ETC

PAINT ON FLOATED PLASTER

Prepare, stop and apply one coat "Plascon" or similar and approved alkali resistant primer and two coats super acrylic emulsion paint for interior use

1	On internal walls	m2	1 532	
---	-------------------	----	-------	--

ON FIBRE CEMENT

Prepare, stop and apply one coat "Plascon" or similar and approved alkali resistant primer and two coats acrylic emulsion paint for interior use

2	On fibre cement ceilings	m2	320	
---	--------------------------	----	-----	--

3	Skimmed gypsum plaster board ceilings	m2	16	
---	---------------------------------------	----	----	--

ON PLASTERBOARD

Prepare, stop and apply one coat "Plascon" or similar and approved alkali resistant primer and two coats acrylic emulsion paint for interior use

4	On plaster board ceilings	m2	264	
---	---------------------------	----	-----	--

Carried to Collection

R

Section No. 2
Bill No 15 - Paintwork

LDPW-B/20151 - BILLS OF QUANTITIES

**CONSTRUCTION OF NEW LIBRARY
INCLUDING ELECTRICAL, MECHANICAL INSTALLATION
AND ASSOCIATED EXTERNAL WORKS
AT VLEIFONTEIN, VHEMBE DISTRICT**

ON METAL

Spot primer defects in pre-primed surfaces with zinc chromate primer, one universal undercoat and two coats "Plascon" or equal and approved enamel paint

5	On pressed steel door frames	m2	40	
6	On steel gates	m2	76	

PAINT ON WOOD

Prepare and paint one coat hardboard primer, one undercoat and two coats high gloss enamel "Plascon" or equal and approved paint

7	On general surfaces	m2	65	
---	---------------------	----	----	--

Prepare, stop and apply three coats FPR 19 Teak clear varnish, lightly sanded down between coats

8	On skirtings not exceeding 300mm girth	m	46	
---	--	---	----	--

Carried to Collection

R

Section No. 2
Bill No 15 - Paintwork

LDPW-B/20151 - BILLS OF QUANTITIES

**CONSTRUCTION OF NEW LIBRARY
INCLUDING ELECTRICAL, MECHANICAL INSTALLATION
AND ASSOCIATED EXTERNAL WORKS
AT VLEIFONTEIN, VHEMBE DISTRICT**

Section No. 2

Bill No. 15

Bill No 15 - Paintwork

COLLECTION

Total Brought Forward from Page No.

**Page
No**

272

Amount

Total Brought Forward from Page No.

273

Total Brought Forward from Page No.

274

Carried Forward to Summary of Section No. 2

R

Section No. 2

Bill No 15 - Paintwork

LDPW-B/20151 - BILLS OF QUANTITIES

**CONSTRUCTION OF NEW LIBRARY
INCLUDING ELECTRICAL, MECHANICAL INSTALLATION
AND ASSOCIATED EXTERNAL WORKS
AT VLEIFONTEIN, VHEMBE DISTRICT**

Bill No	SECTION SUMMARY - Section 2 - Buildings	Page No	Amount
1	Bill No 1 - Earthworks	192	
2	Bill No 2 - Concrete, formwork and reinforcement	201	
3	Bill No 3 - Masonry	208	
4	Bill No 4 - Waterproofing	211	
5	Bill No 5 - Roof Covering	216	
6	Bill No 6 - Carpentry and Joinery	224	
7	Bill No 7 - Ceilings, Partitions and access flooring	229	
8	Bill No 8 - Ironmongery	238	
9	Bill No 9 - Structural Steel	243	
10	Bill No 10 - Metalwork	253	
11	Bill No 11 - Plastering	256	
12	Bill No 12 - Tiling	259	
13	Bill No 13 - Plumbing and drainage	270	
14	Bill No 14 - Glazing	271	
15	Bill No 15 - Paintwork	275	
	Carried to Final Summary		R
	Section No. 2 LDPW-B/20151 - BILLS OF QUANTITIES		

**CONSTRUCTION OF NEW LIBRARY
INCLUDING ELECTRICAL, MECHANICAL INSTALLATION
AND ASSOCIATED EXTERNAL WORKS
AT VLEIFONTEIN, VHEMBE DISTRICT**

Item No		Quantity	Rate	Amount
	<u>BILL NO. 1</u>			
	<u>EARTHWORKS (PROVISIONAL)</u>			
	<u>PREAMBLES</u>			
	For preambles see "Specification of materials and methods to be used - PW 371"			
	<u>SUPPLEMENTARY PREAMBLES</u>			
	<u>Supplementary preambles and full descriptions of materials, items, work, etc. applicable to Section No. 3</u>			
	The Contractor is referred to the previous Section 2 for supplementary preambles and full descriptions of materials, items, work, etc. which shall be regarded to be equally applicable for work described in this Bill, unless specifically otherwise described			
	<u>General</u>			
	The Contractor shall carry out the work with as little mess and noise possible and with a minimum of disturbance to the occupants. The Contractor shall provide proper protection and provide and erect any temporary tarpaulins that may be necessary during the progress of the works, all to the satisfaction of the Principal Agent, and remove when directed			
	<u>Site clearance</u>			
	All rubble, rubbish, vegetable soil, shrubs, bush, trees, etc. shall be removed from the whole area and carted away off the construction site to a suitable dumping site, which has to be located by the Contractor, all to the full satisfaction of the Principal Agent			
	Carried to Collection			
	Section No. 3 Bill No 1 - Earthwork LDPW-B/20151 - BILLS OF QUANTITIES			R

**CONSTRUCTION OF NEW LIBRARY
INCLUDING ELECTRICAL, MECHANICAL INSTALLATION
AND ASSOCIATED EXTERNAL WORKS
AT VLEIFONTEIN, VHEMBE DISTRICT**

Filling (General)

It will be, at all times, required from the Contractor to apply and execute strict quality control on all filling material used

Samples of potential fill material obtained from excavations, trench excavations, etc. are to be submitted to and approved by the Principal Agent prior to the re-use thereof as "filling"

All filling obtained from a commercial source should comply to minimum G6 standard

Should any material be found unsuitable and the use thereof be disapproved, such material shall be disposed and approved material must be sourced and imported from an approved commercial source

Filling in general shall be compacted to the prescribed percentage Mod AASHTO density

CBR and indicator tests

Density tests for monitoring filling shall be done at the minimum prescribed frequencies per each 150mm thick layer of filling placed

The Contractor is to note that all necessary tests (i.e. CBR and indicator tests, etc.) are to be conducted for all filling material, whether obtained from the excavations or to be imported from an approved commercial source

Results of these tests are to be submitted to and approved by the Principal Agent prior to commencement of any placement thereof and/or filling done therewith

Density tests

It will be required from the Contractor to execute density tests for monitoring filling at the following minimum frequencies per each filling layer placed:

Carried to Collection

Section No. 3
Bill No 1 - Earthwork

LDPW-B/20151 - BILLS OF QUANTITIES

R

**CONSTRUCTION OF NEW LIBRARY
INCLUDING ELECTRICAL, MECHANICAL INSTALLATION
AND ASSOCIATED EXTERNAL WORKS
AT VLEIFONTEIN, VHEMBE DISTRICT**

- **Filling to form building platforms, etc:**
1 Test per 200m² plan area per each 150mm thick layer

Results of density tests executed are to be submitted to and approval obtained from the Principal Agent prior commencement of any subsequent fill layers and/or other work

Keeping excavations free from water:

No separate provision has been made in this Bill for measurement and payment for bailing, pumping or otherwise keeping excavations free from water during the construction process of the work measured in this Bill

Therefore, tenderers are to note that their tendered rates are to cater for the above-mentioned as no claims arising out of their failure to do so will afterwards be entertained

Carting away of excessive and/or unsuitable excavated material

Descriptions for "carting away excessive or unsuitable excavated material from site" shall, unless specifically otherwise described, be deemed to include the loading and hauling of excessive or unsuitable excavated material to a suitable dumping site, which has to be located by the Contractor, off the construction site

The location of the intended dumping site will be subjected to the prior written approval of the Principal Agent

The Contractor shall also be liable to, upon completion, to rehabilitate all areas of the site which was disturbed during the construction phase due to construction activities, temporarily dumping/spoiling of excavated material, etc. It will be required from the Contractor to grade such areas to follow the adjacent ground contours and afterwards compacted to 80% Mod AASHTO density, all to the full satisfaction of the Principal Agent

Carried to Collection

Section No. 3
Bill No 1 - Earthwork

LDPW-B/20151 - BILLS OF QUANTITIES

R

**CONSTRUCTION OF NEW LIBRARY
INCLUDING ELECTRICAL, MECHANICAL INSTALLATION
AND ASSOCIATED EXTERNAL WORKS
AT VLEIFONTEIN, VHEMBE DISTRICT**

Tendered rates must make provision for the above-mentioned as no additional claims in this regard will afterwards be entertained

Relevant SANS 1200 Specifications

The following relevant SANS 1200 Specifications shall be regarded applicable:

- Earth mattresses, building platforms, etc:

SANS 1200 AA	General (Small Works)
SANS 1200 C	Site clearance
SANS 1200 D	Earthworks
SANS 1200 ME	Sub-base
SANS 1200 MF	Base

All work related to the above-mentioned elements shall be done with materials specified and in according to methods prescribed by the relevant SANS 1200 referred to

SANS 1200 Specification (General)

The SANS 1200 Specifications as referred to above were drawn up to cover activities normally encountered on civil engineering work, which is equally applicable on work scheduled hereunder for this project

All the specifications referred to above, although not issued with these Bills of Quantities, shall be deemed to form part of this document and shall be considered as applying to the performance of work to be completed in terms of this Section

The Contractor shall obtain a copies of the said specifications from the South African Bureau of Standards and be kept on site at all times

Measurement and payment

Measurement and payment clauses as described in the above-mentioned SANS 1200 Specifications shall not apply to the work as set out in this Bill

Carried to Collection

R

Section No. 3
Bill No 1 - Earthwork

LDPW-B/20151 - BILLS OF QUANTITIES

**CONSTRUCTION OF NEW LIBRARY
INCLUDING ELECTRICAL, MECHANICAL INSTALLATION
AND ASSOCIATED EXTERNAL WORKS
AT VLEIFONTEIN, VHEMBE DISTRICT**

EARTHWORKS

GENERAL SITE CLEARANCE ETC

Clear site

1	Digging up and removing rubbish, debris, vegetation, hedges, and shrubs etc, including stock piling of organic rich topsoil for reuse	m2	5 567
2	Cut surface to a depth of 150mm and cart away from site, rip, break down oversize material where necessary, add suitable material where necessary and compact to 90% MOD AASHTO Density.	m2	2 388

BULK EARTHWORKS AND PODIUMS

(WORK GROUP 104)

Cutting down trees and removing, grubbing up roots and filling in holes

3	Tree not exceeding 500mm girth	No	10
4	Tree exceeding 500mm and not exceeding 1000mm girth	No	5
5	Tree exceeding 1000mm and not exceeding 2000mm girth	No	1

Open face excavation over sloping site

6	Open face excavation in earth to reduce levels under buildings and depositing excavated material over site including haulage not exceeding 1km from perimeter of excavations	m3	346
7	Open face excavation in earth to reduce levels under paved areas and depositing excavated material over site including haulage not exceeding 1km from perimeter of excavations	m3	450

Carried to Collection

R

Section No. 3
Bill No 1 - Earthwork

**CONSTRUCTION OF NEW LIBRARY
INCLUDING ELECTRICAL, MECHANICAL INSTALLATION
AND ASSOCIATED EXTERNAL WORKS
AT VLEIFONTEIN, VHEMBE DISTRICT**

Extra over bulk excavation in earth for excavation in

8	Extra over open face excavations in earth for excavation in soft rock	m3	80
9	Extra over open face excavations in earth for excavations in hard rock	m3	40

Extra over all excavations for carting away

10	Surplus material from stock piles on site to a dumping site to be located by the contractor	m3	381
----	---	----	-----

LAYERWORKS

Earth filling (G6 material) obtained and supplied by the contractor from commercial sources and compacted to 93% Modified AASHTO density

11	Sub-base to from platforms and embankments	m3	380
----	--	----	-----

Earth filling supplied by the Contractor including compactions in layers of 150mm in accordance with the engineers drawings and specifications

12	Rip and recompact insitu materials compacted to 90% MOD AASHTO density	m3	99
13	Base Course layer (G7 material quality) compacted to 90% MOD AASHTO density obtained from commercial source	m3	99
14	Upper selected sub-base layers (G6 material quality) compacted to 93%MOD AASHTO density obtained from commercial source	m3	162
15	Selected sub-base layer (C4 material quality) compacted to 96%MOD AASHTO density obtained from commercial source	m3	141

Carried to Collection

R

Section No. 3
Bill No 1 - Earthwork

**CONSTRUCTION OF NEW LIBRARY
INCLUDING ELECTRICAL, MECHANICAL INSTALLATION
AND ASSOCIATED EXTERNAL WORKS
AT VLEIFONTEIN, VHEMBE DISTRICT**

	<u>Sand bed</u>				
16	20mm Thick dry, clean, washed riversand layer evenly spread over filling (elsewhere), levelled, watered and rammed to receive waterproofing membrane (elsewhere) under solid floors	m3	15		
	<u>STABILIZATION:</u>				
	<u>Chemical stabilization extra over unstabilized compacted layers</u>				
17	Process subbase materials (Chemically stabilised C4 layer, with with UCS>750, GM>1.2 and PI<6), compacted to 95% MOD AASHTO	m3	71		
	<u>B35.01 Chemical stabilizing agent:</u>				
	(a) Common cement to SABS ENV 197-1				
18	CEM IIB-M (32.5N)	t	5		
	<u>Compaction of surfaces</u>				
19	Compaction of insitu ground surface including scarifying for a depth of 150mm, breaking down oversize material, adding suitable material where necessary and compacting to 90% Mod AASHTO density	m2	862		
	<u>Prescribed density test on filling</u>				
20	"Natural california Bearing Ratio" test	No	15		
21	"Modified AASHTO Density" test	No	20		
22	Atterberg limits test in accordance with method A2 to A4 of TMH1	No	10		
23	UCS test in accordance with method A14 of TMH 1	No	10		
	<u>Keeping excavations free of water</u>				
24	Allow for keeping excavations free of water		Item		
	Carried to Collection				R
	Section No. 3 Bill No 1 - Earthwork LDPW-B/20151 - BILLS OF QUANTITIES				

**CONSTRUCTION OF NEW LIBRARY
INCLUDING ELECTRICAL, MECHANICAL INSTALLATION
AND ASSOCIATED EXTERNAL WORKS
AT VLEIFONTEIN, VHEMBE DISTRICT**

LANDSCAPING

25	Provide a sum of R 100 000.00 (One Hundred thousand rands) for Landscaping.	Item	100 000.00
26	Profit	Item	
27	Attendance	Item	

Carried to Collection

R

Section No. 3
Bill No 1 - Earthwork
LDPW-B/20151 - BILLS OF QUANTITIES

**CONSTRUCTION OF NEW LIBRARY
INCLUDING ELECTRICAL, MECHANICAL INSTALLATION
AND ASSOCIATED EXTERNAL WORKS
AT VLEIFONTEIN, VHEMBE DISTRICT**

Section No. 3

Bill No. 1

Bill No 1 - Earthwork

COLLECTION

Total Brought Forward from Page No.

**Page
No**

277

Amount

Total Brought Forward from Page No.

278

Total Brought Forward from Page No.

279

Total Brought Forward from Page No.

280

Total Brought Forward from Page No.

281

Total Brought Forward from Page No.

282

Total Brought Forward from Page No.

283

Total Brought Forward from Page No.

284

Carried Forward to Summary of Section No. 3

R

Section No. 3

Bill No 1 - Earthwork

LDPW-B/20151 - BILLS OF QUANTITIES

**CONSTRUCTION OF NEW LIBRARY
INCLUDING ELECTRICAL, MECHANICAL INSTALLATION
AND ASSOCIATED EXTERNAL WORKS
AT VLEIFONTEIN, VHEMBE DISTRICT**

Item No	Quantity	Rate	Amount
<p><u>BILL NO. 2</u></p> <p><u>RING ROAD (PROVISIONAL)</u></p> <p><u>PREAMBLE</u> These external works bills has been measured in accordance with the engineers specification SABS 1200 and shall be treated as such works</p> <hr/> <p><u>SUPPLEMENTARY PREAMBLES</u></p> <p><u>Nature of Ground Conditions</u></p> <p>A geotechnical survey has been carried out on other surrounding buildings on site by the Engineers and the report is available at the engineers offices for viewings. Description of excavations shall be deemed to include all ground conditions other than "Hard Rock"</p> <p>"Hard Rock" shall mean granite, quartzitic sandstone or other rock of similar hardness which, in the Engineer's opinion, requires drilling, wedging and splitting or the use of explosives, etc.</p> <p><u>Carting Away of Excavated Material</u></p> <p>Descriptions of carting away of excavated material shall be deemed to include loading excavated material onto trucks directly from the excavations or, alternatively, from stock piles situated on the building site</p> <p><u>Concrete pipes:</u></p> <p>Pipes shall be jointed with ogee joints with rubber collars or socket and spigot joints with rubber rings</p> <p style="text-align: right;">Carried to Collection</p> <p>Section No. 3 Bill No 2 - Road Works LDPW-B/20151 - BILLS OF QUANTITIES</p>			R

**CONSTRUCTION OF NEW LIBRARY
INCLUDING ELECTRICAL, MECHANICAL INSTALLATION
AND ASSOCIATED EXTERNAL WORKS
AT VLEIFONTEIN, VHEMBE DISTRICT**

uPVC pipes and fittings:

Soil, waste and vent pipes and fittings shall be solvent weld jointed

uPVC pressure pipes and fittings:

Pipes for water supply shall be of the class stated

Pipes of 40mm diameter and smaller shall be plain ended with solvent welded uPVC loose sockets and fittings

Pipes of 50mm diameter and greater shall have sockets and spigots with push in type integral rubber ring joints. Bends shall be uPVC and all other fittings shall be cast iron, all with similar push-in type joints

Reducing fittings

Where fittings have reducing ends or branches they are described as "reducing". In the case of pipes with diameters not exceeding 60mm only the largest end or branch size is given. Should the contractor wish to use other fittings and bushes or reducers he may do so on the understanding that no claim in this regard will be entertained. In the case of pipes with diameters exceeding 60mm all sizes are given and no claim for extra bushes, reducers, etc will be entertained

Exposed concrete surfaces

Exposed surfaces of concrete stormwater channels, cover slabs, inspection eye marker slabs, gully tops, cleaning eye tops, catchpits, inspection chambers, etc shall be finished smooth with plaster

Permission for protected trees

Carried to Collection

Section No. 3
Bill No 2 - Road Works
LDPW-B/20151 - BILLS OF QUANTITIES

R

**CONSTRUCTION OF NEW LIBRARY
INCLUDING ELECTRICAL, MECHANICAL INSTALLATION
AND ASSOCIATED EXTERNAL WORKS
AT VLEIFONTEIN, VHEMBE DISTRICT**

CONCRETE BLOCK PAVING FOR ROADS

Precast concrete block road surfacing

Paving is to be laid in accordance with SABS 1200 MJ, SABS 1058 and the Concrete Masonry Association's specifications

Paving is to be laid to herringbone pattern on 25mm (thickness after final compaction) clean river sand (preparation of ground or filling elsewhere)

Clean sand is to be swept into joints between roadstones

80mm Standard grey interlocking "Concor " paving blocks

1	Paving to parking areas etc to falls	m2	862	
---	--------------------------------------	----	-----	--

User note

Where SANS 927 in the following three descriptions is not applicable, refer to other suitable construction standards or provide full specifications

2	150 x 300mm High kerbs (SANS 927 fig 3) with 150 x 150 x 300mm unreinforced concrete haunching at back of each joint, including excavation, backfilling, etc	m	146	
---	--	---	-----	--

Unreinforced concrete vertically to paving

25MPa/19mm concrete

3	Extra over for edge beam	m	36	
---	--------------------------	---	----	--

Road signs

4	Standard "STOP" sign with 50mm diameter galvanised mild steel post bedded in and including unreinforced concrete base, including any necessary excavation, paint finish, etc	No	1	
---	--	----	---	--

Carried to Collection

R

Section No. 3
Bill No 2 - Road Works
LDPW-B/20151 - BILLS OF QUANTITIES

**CONSTRUCTION OF NEW LIBRARY
INCLUDING ELECTRICAL, MECHANICAL INSTALLATION
AND ASSOCIATED EXTERNAL WORKS
AT VLEIFONTEIN, VHEMBE DISTRICT**

Paintwork

Two coats reflective road marking paint on tarmacadam

Etching primer and two coats reflective road marking
paint on concrete

5	Line 100mm wide	m	20	
6	Numeral or letter 1.8mm high	No	1	

Carried to Collection

R

Section No. 3
Bill No 2 - Road Works
LDPW-B/20151 - BILLS OF QUANTITIES

**CONSTRUCTION OF NEW LIBRARY
INCLUDING ELECTRICAL, MECHANICAL INSTALLATION
AND ASSOCIATED EXTERNAL WORKS
AT VLEIFONTEIN, VHEMBE DISTRICT**

Section No. 3

Bill No. 2

Bill No 2 - Road Works

COLLECTION

Total Brought Forward from Page No.

**Page
No**

286

Amount

Total Brought Forward from Page No.

287

Total Brought Forward from Page No.

288

Total Brought Forward from Page No.

289

Carried Forward to Summary of Section No. 3

R

Section No. 3

Bill No 2 - Road Works

LDPW-B/20151 - BILLS OF QUANTITIES

**CONSTRUCTION OF NEW LIBRARY
INCLUDING ELECTRICAL, MECHANICAL INSTALLATION
AND ASSOCIATED EXTERNAL WORKS
AT VLEIFONTEIN, VHEMBE DISTRICT**

Item No		Quantity	Rate	Amount
	<p><u>BILL NO. 3</u></p> <p><u>FENCING</u></p> <p><u>PREAMBLE</u> <u>These external works bills has been measured in accordance with the engineers specification SABS 1200 and shall be treated as such works</u></p>			
	<p><u>SUPPLEMENTARY PREAMBLES</u></p> <p><u>User note</u></p> <p><i>In high corrosion areas fence posts, stays, gates, etc are to be galvanised</i></p> <p><u>Galvanised security fence with bitumen-aluminium painted (two coats) steel pipe posts, stays, gates, etc including galvanised steel bolts, straining eye bolts, etc. site clearance and preparation of ground</u></p>			
	Carried to Collection		R	
	<p>Section No. 3 Bill No 3 Fencing LDPW-B/20151 - BILLS OF QUANTITIES</p>			

**CONSTRUCTION OF NEW LIBRARY
INCLUDING ELECTRICAL, MECHANICAL INSTALLATION
AND ASSOCIATED EXTERNAL WORKS
AT VLEIFONTEIN, VHEMBE DISTRICT**

METALWORK

Invisible mesh security fencing including site clearance and preparation of ground (LI)

1	Powder-coated security fencing 2400mm high overall above ground level, of ref 3510 - 3D mesh panels fabricated from absel with a strength of 60% and a tensile strength of 500N/mm ² , with core diameter of 3mm and a tolerance of 0.07mm, with 4No. 43mm V-Profiled horizontal stiffeners, fixed to and including 76 x 45 x 3mm x 3000mm long steel post galvanised and powder-coated, with rubber cap on top, planted in concrete (elsewhere measured). Fencing panels to be securely fixed between posts, with and including galvanised and powder-coated fixators and nuts at centres not exceeding 300mm and to be twisted until they are detached.	m	295
2	Galvanised anti-burrow fencing 500mm high below ground level, secured into concrete for posts and haunching of 200 x 200 x 200mm at 1000mm centres maximum, of ref 3510 - 3D mesh panels fabricated from absel with a strength of 60% and a tensile strength of 500N/mm ² , with core diameter of 3mm and a tolerance of 0.07mm, including trench, backfilling and compacting.	m	295
3	Powder-coated anti-climb structure spiked rail bolted to invisible fence mesh flang along fence top.	m	295
4	Powder-coated security double gate 7000 x 3000mm high formed of 100 x 75 x 3mm frame with 2No. middle vertical and 1No. horizontal rail. Fencing mesh similar to main fence to be secured to gate frame with fixators. Sliding system to be of 2No 100 x 100 x 3mm vertical posts set into and including 20Mpa concrete. 14m of 50 x 50 x 3mm galvanised angle iron with 12mm diameter R12 reinforcing bar welded onto angle iron, with fixing lugs of 25 x 25 x 5mm flat bar at maximum 350mm, set into and including 20Mpa concrete. Top to have powder-coated anti-climb security spiked rail.	No	1

Carried to Collection

R

Section No. 3
Bill No 3 Fencing
LDPW-B/20151 - BILLS OF QUANTITIES

**CONSTRUCTION OF NEW LIBRARY
INCLUDING ELECTRICAL, MECHANICAL INSTALLATION
AND ASSOCIATED EXTERNAL WORKS
AT VLEIFONTEIN, VHEMBE DISTRICT**

5	<p>Powder-coated security swing pedestrian gate 1500 x 3000mm high formed of 100 x 75 x 3mm frame with 2No. horizontal rails. Fencing mesh similar to main fence to be secured to gate frame with fixators. Posts system to be of 2No 100 x 100 x 3mm vertical posts set into and including 20Mpa concrete. Top to have powder-coated anti-climb security spiked rail. Gate to have approved locking mechanism</p>	No	1		
<p>Carried to Collection</p>				R	

Section No. 3
Bill No 3 Fencing
LDPW-B/20151 - BILLS OF QUANTITIES

**CONSTRUCTION OF NEW LIBRARY
INCLUDING ELECTRICAL, MECHANICAL INSTALLATION
AND ASSOCIATED EXTERNAL WORKS
AT VLEIFONTEIN, VHEMBE DISTRICT**

Section No. 3

Bill No. 3

Bill No 3 Fencing

COLLECTION

Total Brought Forward from Page No.

**Page
No**

291

Amount

Total Brought Forward from Page No.

292

Total Brought Forward from Page No.

293

Carried Forward to Summary of Section No. 3

R

Section No. 3

Bill No 3 Fencing

LDPW-B/20151 - BILLS OF QUANTITIES

**CONSTRUCTION OF NEW LIBRARY
INCLUDING ELECTRICAL, MECHANICAL INSTALLATION
AND ASSOCIATED EXTERNAL WORKS
AT VLEIFONTEIN, VHEMBE DISTRICT**

Item No		Quantity	Rate	Amount
	<p><u>BILL NO. 4</u></p> <p><u>MAIN SEWER LINE (PROVISIONAL)</u></p> <p><u>(WORK GROUP 148)</u></p> <p><u>PREAMBLES</u>For preambles refer to <u>"Department of Public Works: Specification of Materials and Method to be used - PW371"</u></p> <p><u>NOTE</u></p> <p>All prices/rates to be net, excluding Value Added Tax</p> <p><u>SUPPLEMENTARY PREAMBLES</u></p> <p>Excavations</p> <p>Prices for excavations must include for necessary staging for risk of collapse of excavation side.</p> <p>Compacting</p> <p>Filling for all types of prices described as "under solid floors, etc" shall be done with approved backfilling and compacted to 93% Mod. AASHTO density, unless otherwise described</p> <p>Testing</p> <p>Descriptions for the testing of plumbing and drainage installations shall be deemed to cater for all testing apparatus, labour, etc. and shall be done strictly as directed by and in accordance to the Principal Agent's instructions, including for retesting after taking out and making good all defective work to his entire satisfaction</p>			
	Carried to Collection		R	
	<p>Section No. 3 Bill No 4 - Main Sewer Line LDPW-B/20151 - BILLS OF QUANTITIES</p>			

**CONSTRUCTION OF NEW LIBRARY
INCLUDING ELECTRICAL, MECHANICAL INSTALLATION
AND ASSOCIATED EXTERNAL WORKS
AT VLEIFONTEIN, VHEMBE DISTRICT**

Vitrified clay pipes:

Pipes shall rest on solid ground and, where necessary, pockets of sufficient size shall be cut around joints to enable the jointing to be properly performed or, alternatively, pipes shall be bedded full length on and including unreinforced concrete laid in a semi-dry state immediately before pipes are laid

Sewer and drainage pipes and fittings shall be jointed and sealed with butyl rubber rings

uPVC pipes and fittings

Sewer and drainage pipes and fittings shall be jointed and sealed with butyl rubber rings

Soil, waste and vent pipe fittings shall be solvent weld jointed

uPVC pressure pipes and fittings

Pipes for water supply shall be of the class stated

Pipes of 40mm diameter and smaller shall be plain ended with solvent welded uPVC loose sockets and fittings

Copper pipes

Pipes shall be hard drawn and half hard pipes of the class stated. Class 0 (thin walled hard drawn pipes) shall not be bent. Class 1 (thin half hard), Class 2 (half hard) and Class 3 (heavy walled half-hard) pipes shall only be bent with benders with inner and outer formers. Fittings to copper waste, vent and anti siphon pipes, capillary solder fittings and compression fittings shall be "Cobra Watertech" type. Capillary solder fittings shall comply with ISO 2016. Only compression fittings shall be used in walls or ground.

Carried to Collection

Section No. 3
Bill No 4 - Main Sewer Line
LDPW-B/20151 - BILLS OF QUANTITIES

R

**CONSTRUCTION OF NEW LIBRARY
INCLUDING ELECTRICAL, MECHANICAL INSTALLATION
AND ASSOCIATED EXTERNAL WORKS
AT VLEIFONTEIN, VHEMBE DISTRICT**

Reducing fittings

Where fittings have reducing ends or branches they are described as "reducing". In the case of pipes with diameters not exceeding 60mm only the largest end or branch size is given. Should the Contractor wish to use other fittings and bushes or reducers, he may do so on the understanding that no claim in this regard will be entertained. In the case of pipes with diameters exceeding 60mm all sizes are given and no claim for extra bushes, reducers will be entertained.

Excavations

No claim for extra rock excavation will be entertained unless the Contractor has timeously notified the Quantity Surveyor, thereof prior to backfilling, in writing

"Soft rock" and "Hard rock" shall be as defined in "Earthworks"

Laying, Backfilling, Bedding, etc. of Pipes

Pipes shall be laid and bedded and trenches shall be carefully backfilled in accordance with the manufacturer's instructions

Where no manufacturer's instructions exist pipes shall be laid in accordance with clauses 5.1 and 5.2 of each of the following: SABS 1200L : Medium Pressure Pipes
LD : Sewers LE : Stormwater Drainage

Pipes trenches, etc. shall be backfilled in accordance with Clauses 3, 5.5, 5.6, 5.7 and 7 of SABS 1200DB: Earthworks (Pipe Trenches)

Pipes shall be bedded in accordance with Clause 3.1 to 3.4.1, 5.1 to 5.3 and 7 of SABS 1200LB : Bedding (Pipes)

Unless otherwise described bedding of rigid pipes shall be Class B bedding

Carried to Collection

Section No. 3
Bill No 4 - Main Sewer Line
LDPW-B/20151 - BILLS OF QUANTITIES

R

**CONSTRUCTION OF NEW LIBRARY
INCLUDING ELECTRICAL, MECHANICAL INSTALLATION
AND ASSOCIATED EXTERNAL WORKS
AT VLEIFONTEIN, VHEMBE DISTRICT**

Flush pans

Flush pans shall have straight or side outlets and "P" or "S" traps as necessary

Waste unions

Description of waste unions shall be deemed to include rubber or vulcanite plugs and chains

DRAINAGE

NOTE: All items in this section shall be deemed to fall into Work Group No 146 for Haylett formula purposes

Nature of Ground Conditions

A geotechnical survey has been carried out on other surrounding buildings on site by the Engineers and the report is available at the engineers offices for viewings. Description of excavations shall be deemed to include all ground conditions other than "Hard Rock"

"Hard Rock" shall mean granite, quartzitic sandstone or other rock of similar hardness which, in the Engineer's opinion, requires drilling, wedging and splitting or the use of explosives, etc.

Carting Away of Excavated Material

Descriptions of carting away of excavated material shall be deemed to include loading excavated material onto trucks directly from the excavations or, alternatively, from stock piles situated on the building site

Carried to Collection

Section No. 3
Bill No 4 - Main Sewer Line
LDPW-B/20151 - BILLS OF QUANTITIES

R

**CONSTRUCTION OF NEW LIBRARY
INCLUDING ELECTRICAL, MECHANICAL INSTALLATION
AND ASSOCIATED EXTERNAL WORKS
AT VLEIFONTEIN, VHEMBE DISTRICT**

Concrete pipes:

Pipes shall be jointed with ogee joints with rubber collars or socket and spigot joints with rubber rings

uPVC pipes and fittings:

Soil, waste and vent pipes and fittings shall be solvent weld jointed

uPVC pressure pipes and fittings:

Pipes for water supply shall be of the class stated

Pipes of 40mm diameter and smaller shall be plain ended with solvent welded uPVC loose sockets and fittings

Pipes of 50mm diameter and greater shall have sockets and spigots with push in type integral rubber ring joints. Bends shall be uPVC and all other fittings shall be cast iron, all with similar push-in type joints

Reducing fittings

Where fittings have reducing ends or branches they are described as "reducing". In the case of pipes with diameters not exceeding 60mm only the largest end or branch size is given. Should the contractor wish to use other fittings and bushes or reducers he may do so on the understanding that no claim in this regard will be entertained. In the case of pipes with diameters exceeding 60mm all sizes are given and no claim for extra bushes, reducers, etc will be entertained

Exposed concrete surfaces

Exposed surfaces of concrete stormwater channels, cover slabs, inspection eye marker slabs, gully tops, cleaning eye tops, catchpits, inspection chambers, etc shall be finished smooth with plaster

Carried to Collection

Section No. 3
Bill No 4 - Main Sewer Line
LDPW-B/20151 - BILLS OF QUANTITIES

R

**CONSTRUCTION OF NEW LIBRARY
INCLUDING ELECTRICAL, MECHANICAL INSTALLATION
AND ASSOCIATED EXTERNAL WORKS
AT VLEIFONTEIN, VHEMBE DISTRICT**

Permission for protected trees

The contractor shall apply to the authorities to seek permission before cutting any trees down

These external works bills has been measured in accordance with the engineers specification SABS 1200 and shall be treated as such works

SITE CLEARANCE

Clear and grub

1	Strips, 1.5m wide	m	81	
---	-------------------	---	----	--

EARTHWORKS (PIPE TRENCHES)

Excavate in all materials for trenches, backfill, compact and dispose of surplus materials:

Pipes over 110mm dia up to 400mm dia for depths:

2	Over 1.0m up to 2.0m	m	81	
---	----------------------	---	----	--

Extra over items above for:

3	Intermediate excavation	m3	8	
---	-------------------------	----	---	--

4	Hard rock excavation	m3	4	
---	----------------------	----	---	--

Particular Items:Labour intensive Method to EPWP

5	Shoring of trenches exceeding a depth of 1.5m		Item	
---	---	--	------	--

Carried to Collection

R

Section No. 3
Bill No 4 - Main Sewer Line
LDPW-B/20151 - BILLS OF QUANTITIES

**CONSTRUCTION OF NEW LIBRARY
INCLUDING ELECTRICAL, MECHANICAL INSTALLATION
AND ASSOCIATED EXTERNAL WORKS
AT VLEIFONTEIN, VHEMBE DISTRICT**

<u>BEDDING (PIPES)</u>					
<u>BEDDING FOR SEWER PIPES</u>					
<u>Supply only of bedding by importation:</u>					
From commercial sources materials:					
6	selected granular materials.	m3	16		
7	selected fill materials	m3	15		
<u>Concrete bedding cradle:</u>					
8	Class 15MPa/19mm	m3	5		
<u>Encasing of pipes in concrete</u>					
9	Class 15MPa/19mm	m3	5		
<u>PIPE LAYING SEWERS</u>					
<u>Supply, Lay, joint, bed on class C bedding and test pipeline:</u>					
uPVC (SABS 791) pipes of diameter					
10	160mm Dia	m	81		
Extra over for fittings					
11	160mm Dia bends	No	3		
<u>Precast concrete manhole:</u>					
Supply all materials and labor for the construction of concrete manholes from precast sections complete with cover frame, including step irons, channeling, benching, grouting, sockets, etc. in the following Dia. and depth categories					
12	1000mm Dia. 1.5m up to 2.9m	No	4		
Carried to Collection					
Section No. 3					
Bill No 4 - Main Sewer Line					
LDPW-B/20151 - BILLS OF QUANTITIES					

R

**CONSTRUCTION OF NEW LIBRARY
INCLUDING ELECTRICAL, MECHANICAL INSTALLATION
AND ASSOCIATED EXTERNAL WORKS
AT VLEIFONTEIN, VHEMBE DISTRICT**

<u>Extra over items above for testing water tightness</u>				
13	Testing of tightness of manholes including all work and materials necessary as specified, only where instructed by the Engineer		Item	
<u>Anchor blocks:</u>				
14	Grade 20/40 mass concrete anchor blocks on steep slopes as specified and detailed on the drawings where instructed ny the Engineers	m3	3.00	
<u>SEWER TREATMENT WORKS</u>				
15	Construct a septic tank 2460 x 7310 x 2600mm high with soak away, constructed with 25Mpa bottom and top slab, waterproof plastered brickwork and 550mm dia. manhole covers as per the Engineer's drawing attached to this Bill of Quantities.		Item	
<u>SEWER MAIN MUNICIPAL CONNECTION FEE</u>				20 000.00
16	Provide a sum of R 20 000.00 (Twety thousand rands) for municipal connection fee.		Item	
17	Profit		Item	
18	Attendance		Item	
Carried to Collection				R
Section No. 3				
Bill No 4 - Main Sewer Line				
LDPW-B/20151 - BILLS OF QUANTITIES				

**CONSTRUCTION OF NEW LIBRARY
INCLUDING ELECTRICAL, MECHANICAL INSTALLATION
AND ASSOCIATED EXTERNAL WORKS
AT VLEIFONTEIN, VHEMBE DISTRICT**

Section No. 3

Bill No. 4

Bill No 4 - Main Sewer Line

COLLECTION

Total Brought Forward from Page No.
Total Brought Forward from Page No.
Total Brought Forward from Page No.
Total Brought Forward from Page No.
Total Brought Forward from Page No.
Total Brought Forward from Page No.
Total Brought Forward from Page No.
Total Brought Forward from Page No.

**Page
No**

295
296
297
298
299
300
301
302

Amount

Carried Forward to Summary of Section No. 3

Section No. 3
Bill No 4 - Main Sewer Line
LDPW-B/20151 - BILLS OF QUANTITIES

R

**CONSTRUCTION OF NEW LIBRARY
INCLUDING ELECTRICAL, MECHANICAL INSTALLATION
AND ASSOCIATED EXTERNAL WORKS
AT VLEIFONTEIN, VHEMBE DISTRICT**

Item No		Quantity	Rate	Amount
	<p><u>BILL NO. 5</u></p> <p><u>WATER AND FIRE RETICULATION</u></p> <p>PREAMBLES For preambles refer to "Department of Public Works: Specification of Materials and Method to be used - PW371"</p>			
	<p><u>NOTE</u></p> <p>All prices/rates to be net, excluding Value Added Tax</p> <p><u>SUPPLEMENTARY PREAMBLES</u></p> <p>Excavations</p> <p>Prices for excavations must include for necessary staging for risk of collapse of excavation side.</p> <p>Compacting</p> <p>Filling for all types of prices described as "under solid floors, etc" shall be done with approved backfilling and compacted to 93% Mod. AASHTO density, unless otherwise described</p> <p>Testing</p> <p>Descriptions for the testing of plumbing and drainage installations shall be deemed to cater for all testing apparatus, labour, etc. and shall be done strictly as directed by and in accordance to the Principal Agent's instructions, including for retesting after taking out and making good all defective work to his entire satisfaction</p>			
	<p>Carried to Collection</p>		R	
	<p>Section No. 3 Bill No 5 - Water Reticulation LDPW-B/20151 - BILLS OF QUANTITIES</p>			

**CONSTRUCTION OF NEW LIBRARY
INCLUDING ELECTRICAL, MECHANICAL INSTALLATION
AND ASSOCIATED EXTERNAL WORKS
AT VLEIFONTEIN, VHEMBE DISTRICT**

Vitrified clay pipes:

Pipes shall rest on solid ground and, where necessary, pockets of sufficient size shall be cut around joints to enable the jointing to be properly performed or, alternatively, pipes shall be bedded full length on and including unreinforced concrete laid in a semi-dry state immediately before pipes are laid

Sewer and drainage pipes and fittings shall be jointed and sealed with butyl rubber rings

uPVC pipes and fittings

Sewer and drainage pipes and fittings shall be jointed and sealed with butyl rubber rings

Soil, waste and vent pipe fittings shall be solvent weld jointed

uPVC pressure pipes and fittings

Pipes for water supply shall be of the class stated

Pipes of 40mm diameter and smaller shall be plain ended with solvent welded uPVC loose sockets and fittings

Copper pipes

Pipes shall be hard drawn and half hard pipes of the class stated. Class 0 (thin walled hard drawn pipes) shall not be bent. Class 1 (thin half hard), Class 2 (half hard) and Class 3 (heavy walled half-hard) pipes shall only be bent with benders with inner and outer formers. Fittings for copper waste, vent and anti siphon pipes, capillary solder fittings and compression fittings shall be "Cobra Watertech" type. Capillary solder fittings shall comply with ISO 2016. Only compression fittings shall be used in walls or ground.

Carried to Collection

Section No. 3
Bill No 5 - Water Reticulation
LDPW-B/20151 - BILLS OF QUANTITIES

R

**CONSTRUCTION OF NEW LIBRARY
INCLUDING ELECTRICAL, MECHANICAL INSTALLATION
AND ASSOCIATED EXTERNAL WORKS
AT VLEIFONTEIN, VHEMBE DISTRICT**

Reducing fittings

Where fittings have reducing ends or branches they are described as "reducing". In the case of pipes with diameters not exceeding 60mm only the largest end or branch size is given. Should the Contractor wish to use other fittings and bushes or reducers, he may do so on the understanding that no claim in this regard will be entertained. In the case of pipes with diameters exceeding 60mm all sizes are given and no claim for extra bushes, reducers will be entertained.

Excavations

No claim for extra rock excavation will be entertained unless the Contractor has timeously notified the Quantity Surveyor, thereof prior to backfilling, in writing

"Soft rock" and "Hard rock" shall be as defined in "Earthworks"

Laying, Backfilling, Bedding, etc. of Pipes

Pipes shall be laid and bedded and trenches shall be carefully backfilled in accordance with the manufacturer's instructions

Where no manufacturer's instructions exist pipes shall be laid in accordance with clauses 5.1 and 5.2 of each of the following: SABS 1200L : Medium Pressure Pipes
LD : Sewers LE : Stormwater Drainage

Pipes trenches, etc. shall be backfilled in accordance with Clauses 3, 5.5, 5.6, 5.7 and 7 of SABS 1200DB: Earthworks (Pipe Trenches)

Pipes shall be bedded in accordance with Clause 3.1 to 3.4.1, 5.1 to 5.3 and 7 of SABS 1200LB : Bedding (Pipes)

Unless otherwise described bedding of rigid pipes shall be Class B bedding

Carried to Collection

Section No. 3
Bill No 5 - Water Reticulation
LDPW-B/20151 - BILLS OF QUANTITIES

R

**CONSTRUCTION OF NEW LIBRARY
INCLUDING ELECTRICAL, MECHANICAL INSTALLATION
AND ASSOCIATED EXTERNAL WORKS
AT VLEIFONTEIN, VHEMBE DISTRICT**

<u>Flush pans</u>					
Flush pans shall have straight or side outlets and "P" or "S" traps as necessary					
<u>Waste unions</u>					
Description of waste unions shall be deemed to include rubber or vulcanite plugs and chains					
<u>These external works bills has been measured in accordance with the engineers specification SABS 1200 and shall be treated as such works</u>					
<u>Site Clearance</u>					
1	Clear vegetation in length of pipeline route 1.5m wide (Provisional)	m	229		
<u>Excavation for trenches</u>					
2	Excavate in earth below natural ground level, reduced or made up ground level, not exceeding 2m deep, for:	m	229		
3	Extra-over for excavations in intermediate material	m3	23		
4	Extra-over for excavations in rock (Provisional)	m3	11		
5	Excavate and dispose of unsuitable material from trench bottom	m3	27		
<u>Backfill and compaction</u>					
6	Backfill and compact trenches using labour intensive methods	m3	10		
<u>Imported bedding materials:</u>					
(Bedding to be class C for flexible pipes as indicated in the contract drawings)					
7	Provision of bedding imported from commercial source using selected granular material	m3	48		
Carried to Collection					
Section No. 3					
Bill No 5 - Water Reticulation					
LDPW-B/20151 - BILLS OF QUANTITIES					
					R

**CONSTRUCTION OF NEW LIBRARY
INCLUDING ELECTRICAL, MECHANICAL INSTALLATION
AND ASSOCIATED EXTERNAL WORKS
AT VLEIFONTEIN, VHEMBE DISTRICT**

Supply, Lay and bed uPVC pipe complete: (The rate shall exclude disinfection of pipes after completion of hydraulic pipe test)

8	50mm Dia uPVC pipe class 9	m	229	
---	----------------------------	---	-----	--

Extra Over Fittings and specials - uPVC bends

9	50mm 45 degree bend	No	1	
---	---------------------	----	---	--

10	50mm 90 degree bend	No	2	
----	---------------------	----	---	--

Extra Over Special fittings - uPVC Tees

11	50mm dia. Equal Tees	No	2	
----	----------------------	----	---	--

Special fittings - Fire Hydrant Bend: (Cast iron fire hydrant, Bitumen dipped and LYING sockets to SABS 546 and SABS 966 with flanged branch, 80mm dia, drilled to SABS 1123, Table 16.)

12	50mm Dia.	No	2	
----	-----------	----	---	--

Extra over for special fittings - end caps:

13	50mm Dia.	No	4	
----	-----------	----	---	--

Extra over for special fittings - Isolation Valves: (Flanged RSV isolation valves. Valves to be non-rising spindles with cap top)

14	50mm Dia PN16	No	2	
----	---------------	----	---	--

Valve Chamber:

15	Valve chamber - 1200 x 1400 x 1000mm deep, complete including excavations, materials, plant, labor, incidentals, etc. as per detail drawings.	No	2	
----	---	----	---	--

Hydraulic pipe testing

Pipes

16	50mm dia. uPVC class 9	m	229.00	
----	------------------------	---	--------	--

Carried to Collection

R

Section No. 3
Bill No 5 - Water Reticulation
LDPW-B/20151 - BILLS OF QUANTITIES

**CONSTRUCTION OF NEW LIBRARY
INCLUDING ELECTRICAL, MECHANICAL INSTALLATION
AND ASSOCIATED EXTERNAL WORKS
AT VLEIFONTEIN, VHEMBE DISTRICT**

<u>Disinfecting pipe works</u>			
	Pipes		
17	50mm dia. uPVC class 9	m	229.00
<u>Thrust Blocks:</u>			
18	Excavations	m3	5
19	Formwork	m2	10
20	Concrete (Class 20/19Mpa)	m3	5
<u>ELEVATED AND GROUND TANKS</u>			
21	Provide a sum of R 350 000.00 (Three hundred Fifty thousand rands) for supply and installation 21 700 Litre pressed steel elevated tank including commissioning and connections.	Item	350 000.00
22	Profit	Item	
23	Attendance	Item	
24	Provide a sum of R 40 000.00 (Forty thousand rands) for supply and installation of 5000 litre tank including stand, commissioning and connections.	Item	40 000.00
25	Profit	Item	
26	Attendance	Item	
<u>BOREHOLE</u>			
27	Provide a sum of R 300 000.00 (Three hundred Fifty thousand rands) for drilling, equipping, commissioning and connection of borehole.	Item	300 000.00
28	Profit	Item	
29	Attendance	Item	
Carried to Collection			R
Section No. 3			
Bill No 5 - Water Reticulation			
LDPW-B/20151 - BILLS OF QUANTITIES			

**CONSTRUCTION OF NEW LIBRARY
INCLUDING ELECTRICAL, MECHANICAL INSTALLATION
AND ASSOCIATED EXTERNAL WORKS
AT VLEIFONTEIN, VHEMBE DISTRICT**

WATER MAIN MUNICIPAL CONNECTION FEE

30	Provide a sum of R 10 000.00 (Ten thousand rands) for municipal connection fee.	Item	10 000.00
31	Profit	Item	
32	Attendance	Item	

Carried to Collection

R

Section No. 3
Bill No 5 - Water Reticulation
LDPW-B/20151 - BILLS OF QUANTITIES

**CONSTRUCTION OF NEW LIBRARY
INCLUDING ELECTRICAL, MECHANICAL INSTALLATION
AND ASSOCIATED EXTERNAL WORKS
AT VLEIFONTEIN, VHEMBE DISTRICT**

Section No. 3

Bill No. 5

Bill No 5 - Water Reticulation

COLLECTION

Total Brought Forward from Page No.

**Page
No**

304

Amount

Total Brought Forward from Page No.

305

Total Brought Forward from Page No.

306

Total Brought Forward from Page No.

307

Total Brought Forward from Page No.

308

Total Brought Forward from Page No.

309

Total Brought Forward from Page No.

310

Carried Forward to Summary of Section No. 3

R

Section No. 3

Bill No 5 - Water Reticulation

LDPW-B/20151 - BILLS OF QUANTITIES

**CONSTRUCTION OF NEW LIBRARY
INCLUDING ELECTRICAL, MECHANICAL INSTALLATION
AND ASSOCIATED EXTERNAL WORKS
AT VLEIFONTEIN, VHEMBE DISTRICT**

SECTION SUMMARY - Section 3 - External Works

Bill No		Page No	Amount
1	Bill No 1 - Earthwork	285	
2	Bill No 2 - Road Works	290	
3	Bill No 3 Fencing	294	
4	Bill No 4 - Main Sewer Line	303	
5	Bill No 5 - Water Reticulation	311	
Carried to Final Summary			
Section No. 3 LDPW-B/20151 - BILLS OF QUANTITIES			R

**CONSTRUCTION OF NEW LIBRARY
INCLUDING ELECTRICAL, MECHANICAL INSTALLATION
AND ASSOCIATED EXTERNAL WORKS
AT VLEIFONTEIN, VHEMBE DISTRICT**

Item No		Quantity	Rate	Amount
	<p><u>BILL NO. 1</u></p> <p>PREAMBLES For preambles refer to "Department of Public Works: Specification of Materials and Method to be used - PW371"</p>			
	<p><u>NOTE</u></p> <p>All prices/rates to be net, excluding Value Added Tax</p> <p><u>MV RETICULATION</u></p>			
1	Supply and install 50kVA 11kV/400V transformer complete with structures and poles.	Item		
	Carried Forward to Summary of Section No. 4		R	
	<p>Section No. 4 Bill No 1 - MV Reticulation LDPW-B/20151 - BILLS OF QUANTITIES</p>			

**CONSTRUCTION OF NEW LIBRARY
INCLUDING ELECTRICAL, MECHANICAL INSTALLATION
AND ASSOCIATED EXTERNAL WORKS
AT VLEIFONTEIN, VHEMBE DISTRICT**

Item No		Quantity	Rate	Amount
	<u>BILL NO. 2</u>			
	PREAMBLES For preambles refer to "Department of Public Works: Specification of Materials and Method to be used - PW371"			
	<u>NOTE</u>			
	All prices/rates to be net, excluding Value Added Tax			
	<u>LV RETICULATION</u>			
	<u>Distribution Kiosks</u>			
	<u>3CR12, Powder coated, plinth mounted, complete with equipment as specified</u>			
1	Installation of New Kiosk	No	1	
2	Plinth	No	1	
	<u>Trenching</u>			
	<u>Excavation, bedding, backfilling, consolidating and making good as specified.</u>			
3	Pickable earth	m3	56	
4	Soft rock	m3	24	
5	Hard rock	m3	17	
6	Backfilling and compaction	m3	80	
7	75mm Dia. PVC sleeves for road crossing/cable entries into the building-rate must include for galvanised steel draw wires in spare sleeves and sealing of ends.	m	50	
	Carried to Collection			R
	Section No. 4 Bill No 2 - LV Reticulation LDPW-B/20151 - BILLS OF QUANTITIES			

**CONSTRUCTION OF NEW LIBRARY
INCLUDING ELECTRICAL, MECHANICAL INSTALLATION
AND ASSOCIATED EXTERNAL WORKS
AT VLEIFONTEIN, VHEMBE DISTRICT**

8	Concrete slabs for crossing of other services-rate must include installation 200mm below existing services	m	5		
9	Cable warning tape, 300mm above cable	m	280		
10	Cable marker, above cables	No	8		
11	600/1000V PVC SWA cables, in trenches and sleeves, including labels	m	5		
12	35mm ² 4core	m	120		
13	10mm ² 3core	m	115		
14	6mm ² 4core	m	45		
15	6mm ² 2core	m	30		
	<u>600/1000V Cable terminations, for PVC PVC SWA PVC Cu cables, for indoor or outdoor use, as required</u>				
16	Gland no 5 complete with shroud	No	4		
17	Gland no 4 complete with shroud	No	2		
18	Gland no 2 complete with shroud	No	4		
	<u>Earth conductors (HDHC), including ends</u>				
19	25mm ²	m	120		
20	6mm ²	m	115		
21	4mm ²	m	75		
	<u>Electrical Test</u>				
22	Testing of this section in the presence of 'the Employer and/or the Engineer, including all equipment, power generator, etc.			Item	
23	Electrical & Telkom Man holes 600 x 600 x 600mm	No	1		
	Carried to Collection				R
	Section No. 4 Bill No 2 - LV Reticulation LDPW-B/20151 - BILLS OF QUANTITIES				

**CONSTRUCTION OF NEW LIBRARY
INCLUDING ELECTRICAL, MECHANICAL INSTALLATION
AND ASSOCIATED EXTERNAL WORKS
AT VLEIFONTEIN, VHEMBE DISTRICT**

Section No. 4

Bill No. 2

Bill No 2 - LV Reticulation

COLLECTION

Total Brought Forward from Page No.

Total Brought Forward from Page No.

**Page
No**

314

315

Amount

Carried Forward to Summary of Section No. 4

R

Section No. 4

Bill No 2 - LV Reticulation

LDPW-B/20151 - BILLS OF QUANTITIES

**CONSTRUCTION OF NEW LIBRARY
INCLUDING ELECTRICAL, MECHANICAL INSTALLATION
AND ASSOCIATED EXTERNAL WORKS
AT VLEIFONTEIN, VHEMBE DISTRICT**

Item No		Quantity	Rate	Amount
	<p><u>BILL NO. 3</u></p> <p>PREAMBLES For preambles refer to "Department of Public Works: Specification of Materials and Method to be used - PW371"</p>			
	<p><u>NOTE</u></p> <p>All prices/rates to be net, excluding Value Added Tax</p>			
	<p><u>MAIN LIBRARY BUILDING</u></p>			
	<p><u>Draw Wires</u></p>			
1	Supply and install a 0,6mm diameter galvanised draw wire in sleeves and conduit for data installation	m	600	
	<p><u>Distribution Boards</u></p>			
	<p><u>Supply, delivery, storage and submission of workshop drawings for the Flush mounted architrave steel type power distribution boards complete with flush trays, doors, switch gear mounting trays, copper busbars, neutral and earth bars, correctly sized internally</u></p>			
2	Supply and installation of DB - LIB as per Engineer's specification		Item	
	<p><u>Conduit Work</u></p>			
	<p><u>Supply, delivery and installation of SABS approved PVC / Galvanised Conduits completed with all required conduit accessories.</u></p>			
	Carried to Collection			R
	<p>Section No. 4 Bill No 3 - Main Library Building LDPW-B/20151 - BILLS OF QUANTITIES</p>			

**CONSTRUCTION OF NEW LIBRARY
INCLUDING ELECTRICAL, MECHANICAL INSTALLATION
AND ASSOCIATED EXTERNAL WORKS
AT VLEIFONTEIN, VHEMBE DISTRICT**

	<u>Built or Chase into brick or concrete work:</u>				
3	20mm PVC Conduit	m	400		
4	25mm PVC Conduit	m	50		
	<u>In Ceiling space and steel work or along Purlins</u>				
5	20mm PVC Conduit	m	600		
6	25mm PVC Conduit	m	60		
7	50mm PVC Conduit	m	35		
	<u>Conduit Boxes:</u>				
	<u>Supply and installation of SABS approved conduit boxes, installed in the run of the conduit installation, cast into concrete and built into brickwork or flush inside false ceiling spaces, complete with all required conduit termination accessories.</u>				
8	20mm diameter 4 way type(round box) PVC	No	60		
	<u>Wall Boxes:</u>				
	<u>Supply and installation of SABS approved galvanised pressed steel wall boxes for building flush into brickwork or cast into concrete work.</u>				
	<u>Flush mounted type:</u>				
9	100 x 50 x 50mm	No	12		
10	100 x 100 x 50mm	No	103		
11	100x100mm blank cover	No	15		
	Carried to Collection				R
	Section No. 4				
	Bill No 3 - Main Library Building				
	LDPW-B/20151 - BILLS OF QUANTITIES				

**CONSTRUCTION OF NEW LIBRARY
INCLUDING ELECTRICAL, MECHANICAL INSTALLATION
AND ASSOCIATED EXTERNAL WORKS
AT VLEIFONTEIN, VHEMBE DISTRICT**

	<u>PVC Wiring in conduits:</u>				
12	2.5mm ² for lights circuits	m	1 500		
13	4mm ² for plug sockets circuits	m	2 100		
	<u>Stranded Bare Copper Earth Wire</u>				
	<u>Supply and installation of stranded bare copper earth wire along with PVC wiring in conduits. Tendered rates shall make provision for wastage.</u>				
14	1.5mm ²	m	1 500		
15	2.5mm ²	m	2 100		
	<u>Light Switches:</u>				
	<u>Supply and installation of SABS approved type 16A flush and surface type light switches. Final paint finishes shall be confirmed at a later stage, allowance shall however be made as specified in the general specification. All boxes for flush mounting means</u>				
16	1 Lever 1 way	No	12		
17	1 Lever 2 way	No	4		
18	Photo cell	No	1		
19	Occupancy Sensor	No	2		
20	Motion Sensor	No	3		
	Carried to Collection				
	Section No. 4 Bill No 3 - Main Library Building LDPW-B/20151 - BILLS OF QUANTITIES				R

**CONSTRUCTION OF NEW LIBRARY
INCLUDING ELECTRICAL, MECHANICAL INSTALLATION
AND ASSOCIATED EXTERNAL WORKS
AT VLEIFONTEIN, VHEMBE DISTRICT**

Socket Outlets:

Supply and installation of SABS approved switched and unswitched type flush and surface mounted type 16A switched socket outlets suitable for mounting in flush steel wall boxes or in steel pedestal units or on surface.

The final colour of the paint finish shall be confirmed at a later stage, allowance shall be made as specified in the specification.

All flush type boxes and special pedestals measured elsewhere.

Flush switched sockets type:

21	Single 16A ZA Plug Socket Outlet @300 A.F.F.L	No	40
22	Double 16A ZA Plug Socket Outlet @1200 A.F.F.L	No	1
23	16A 3 pin water tight double socket outlets	No	4
24	16A 3 pin single dedicated socket outlets	No	14
25	RJ 45 DATA outlet	No	18
26	RJ 11 telephone point	No	5
27	Type D: Wall mounted power cluster socket outlets	No	16

Carried to Collection

R

Section No. 4
Bill No 3 - Main Library Building
LDPW-B/20151 - BILLS OF QUANTITIES

**CONSTRUCTION OF NEW LIBRARY
INCLUDING ELECTRICAL, MECHANICAL INSTALLATION
AND ASSOCIATED EXTERNAL WORKS
AT VLEIFONTEIN, VHEMBE DISTRICT**

Light Fittings:

Supply, delivery to site, storage and installation of the below specified light fittings complete with lamps, fixing material, mounting and tubes. Allowance must be made in the rates for all the required fixing materials and accessories.

Fittings to be equal and similar approved to the below quoted manufacture.

28	TYPE B: 4 Inch 10W LED downlight with with battery backup	No	4
29	TYPE B: 4 INCH 10W LED downlight	No	20
30	18W LED RONDO downlight without Dali modification	No	22
31	18W LED rondo downlight with battery backup	No	7
32	18W LED Up & Down facing IP44 Stainless steel wall light	No	7
33	15W LED round bulkhead	No	11
34	VISUAL LED IP40 - 50W 2250x50mm suspended linear fitting	No	5
35	1200x600mm LED panel recessed light fitting with battery backup	No	11
36	1200x600mm LED Panel recessed light fitting without Dali modification	No	43

Electrical Tests:

Making provision for the required inspection, tests and the commissioning of the complete installation and the issuing of the required certificate.

37	Building installation		Item
----	-----------------------	--	------

Carried to Collection

R

Section No. 4
Bill No 3 - Main Library Building

LDPW-B/20151 - BILLS OF QUANTITIES

**CONSTRUCTION OF NEW LIBRARY
INCLUDING ELECTRICAL, MECHANICAL INSTALLATION
AND ASSOCIATED EXTERNAL WORKS
AT VLEIFONTEIN, VHEMBE DISTRICT**

Others:

38	The installation of Telephone Distribution board as specified, lockable, flush mounted (380 x 380 x 120mm) complete with doors, frames, sub-frames and 20mm thick soft board panel as per Engineer's specifications	No	1
39	100 x 100 x 50mm - Draw box for Communication complete with blank cover	No	1
40	2 compartment power skirting installed in offices	m	85
41	Data and Telephone points on Powerskirting; must include draw box, blank cover plate, etc,	No	50
42	P9000 cable tray for small power and Data	m	70
43	Supply and install earthing and lightning protection installations as per Engineer's specification		Item
44	30A TP Isolator, in suitable York Box, for HVAC/three phase isolators	No	2
45	30A SP Isolator, in suitable York Box, for HVAC/single phase isolators	No	9

Carried to Collection

R

Section No. 4
Bill No 3 - Main Library Building
LDPW-B/20151 - BILLS OF QUANTITIES

**CONSTRUCTION OF NEW LIBRARY
INCLUDING ELECTRICAL, MECHANICAL INSTALLATION
AND ASSOCIATED EXTERNAL WORKS
AT VLEIFONTEIN, VHEMBE DISTRICT**

Section No. 4

Bill No. 3

Bill No 3 - Main Library Building

COLLECTION

Total Brought Forward from Page No.

**Page
No**

317

Amount

Total Brought Forward from Page No.

318

Total Brought Forward from Page No.

319

Total Brought Forward from Page No.

320

Total Brought Forward from Page No.

321

Total Brought Forward from Page No.

322

Carried Forward to Summary of Section No. 4

R

Section No. 4

Bill No 3 - Main Library Building

LDPW-B/20151 - BILLS OF QUANTITIES

**CONSTRUCTION OF NEW LIBRARY
INCLUDING ELECTRICAL, MECHANICAL INSTALLATION
AND ASSOCIATED EXTERNAL WORKS
AT VLEIFONTEIN, VHEMBE DISTRICT**

Item No		Quantity	Rate	Amount
	<u>BILL NO. 4</u>			
	PREAMBLES For preambles refer to "Department of Public Works: Specification of Materials and Method to be used - PW371"			
	<u>NOTE</u>			
	All prices/rates to be net, excluding Value Added Tax			
	<u>GUARD HOUSE</u>			
	<u>Draw Wires</u>			
1	Supply and install a 0,6mm diameter galvanised draw wire in sleeves and conduit for data installation	m	20	
	<u>Distribution Boards</u>			
	<u>Supply, delivery, storage and submission of workshop drawings for the Flush mounted architrave steel type power distribution boards complete with flush trays, doors, switch gear mounting trays, copper busbars, neutral and earth bars, correctly sized internally</u>			
2	Supply and installation of DB - LIB as per Engineer's specification		Item	
	Carried to Collection			R
	Section No. 4 Bill No 4 - Guard House LDPW-B/20151 - BILLS OF QUANTITIES			

**CONSTRUCTION OF NEW LIBRARY
INCLUDING ELECTRICAL, MECHANICAL INSTALLATION
AND ASSOCIATED EXTERNAL WORKS
AT VLEIFONTEIN, VHEMBE DISTRICT**

Conduit Work

Supply, delivery and installation of SABS approved PVC / Galvanised Conduits completed with all required conduit accessories.

Built or Chase into brick or concrete work:

3	20mm PVC Conduit	m	30	
---	------------------	---	----	--

4	25mm PVC Conduit	m	40	
---	------------------	---	----	--

In Ceiling space and steel work or along Purlins

5	20mm PVC Conduit	m	20	
---	------------------	---	----	--

Conduit Boxes:

Supply and installation of SABS approved conduit boxes, installed in the run of the conduit installation, cast into concrete and built into brickwork or flush inside false ceiling spaces, complete with all required conduit termination accessories.

6	20mm diameter 4 way type(round box) PVC	No	2	
---	---	----	---	--

Wall Boxes:

Supply and installation of SABS approved galvanised pressed steel wall boxes for building flush into brickwork or cast into concrete work.

Flush mounted type:

7	100 x 50 x 50mm	No	2	
---	-----------------	----	---	--

8	100 x 100 x 50mm	No	3	
---	------------------	----	---	--

PVC Wiring in conduits:

9	2.5mm ² for lights circuits	m	30	
---	--	---	----	--

Carried to Collection

R

Section No. 4
Bill No 4 - Guard House

**CONSTRUCTION OF NEW LIBRARY
INCLUDING ELECTRICAL, MECHANICAL INSTALLATION
AND ASSOCIATED EXTERNAL WORKS
AT VLEIFONTEIN, VHEMBE DISTRICT**

10	4mm ² for plug sockets circuits	m	80		
	<u>Stranded Bare Copper Earth Wire</u>				
	<u>Supply and installation of stranded bare copper earth wire along with PVC wiring in conduits. Tendered rates shall make provision for wastage.</u>				
11	1.5mm ²	m	30		
	<u>Light Switches:</u>				
	<u>Supply and installation of SABS approved type 16A flush and surface type light switches. Final paint finishes shall be confirmed at a later stage, allowance shall however be made as specified in the general specification. All boxes for flush mounting means</u>				
12	1 Lever 1 way	No	2		
13	Photo cell	No	1		
	<u>Socket Outlets:</u>				
	<u>Supply and installation of SABS approved switched and unswitched type flush and surface mounted type 16A switched socket outlets suitable for mounting in flush steel wall boxes or in steel pedestal units or on surface.</u>				
	<u>The final colour of the paint finish shall be confirmed at a later stage, allowance shall be made as specified in the specification.</u>				
	<u>All flush type boxes and special pedestals measured elsewhere.</u>				
	<u>Flush switched sockets type:</u>				
14	16A 3 pin single socket outlets	No	2		
	Carried to Collection				R
	Section No. 4 Bill No 4 - Guard House				
	LDPW-B/20151 - BILLS OF QUANTITIES				

**CONSTRUCTION OF NEW LIBRARY
INCLUDING ELECTRICAL, MECHANICAL INSTALLATION
AND ASSOCIATED EXTERNAL WORKS
AT VLEIFONTEIN, VHEMBE DISTRICT**

Light Fittings:

Supply, delivery to site, storage and installation of the below specified light fittings complete with lamps, fixing material, mounting and tubes. Allowance must be made in the rates for all the required fixing materials and accessories.

Fittings to be equal and similar approved to the below quoted manufacture.

15	24W LED wall/ceiling mounted bulkhead	No	6	
----	---------------------------------------	----	---	--

Electrical Tests:

Making provision for the required inspection, tests and the commissioning of the complete installation and the issuing of the required certificate.

16	Supply and install Earthing and Lightning Protection as per Engineer's specification.		Item	
----	---	--	------	--

Others

17	Provide 2kVA UPS		Item	
----	------------------	--	------	--

Carried to Collection

R

Section No. 4
Bill No 4 - Guard House

LDPW-B/20151 - BILLS OF QUANTITIES

**CONSTRUCTION OF NEW LIBRARY
INCLUDING ELECTRICAL, MECHANICAL INSTALLATION
AND ASSOCIATED EXTERNAL WORKS
AT VLEIFONTEIN, VHEMBE DISTRICT**

Section No. 4

Bill No. 4

Bill No 4 - Guard House

COLLECTION

Total Brought Forward from Page No.

**Page
No**

324

Amount

Total Brought Forward from Page No.

325

Total Brought Forward from Page No.

326

Total Brought Forward from Page No.

327

Carried Forward to Summary of Section No. 4

R

Section No. 4

Bill No 4 - Guard House

LDPW-B/20151 - BILLS OF QUANTITIES

**CONSTRUCTION OF NEW LIBRARY
INCLUDING ELECTRICAL, MECHANICAL INSTALLATION
AND ASSOCIATED EXTERNAL WORKS
AT VLEIFONTEIN, VHEMBE DISTRICT**

Item No		Quantity	Rate	Amount
	<u>BILL NO. 5</u>			
	PREAMBLES For preambles refer to "Department of Public Works: Specification of Materials and Method to be used - PW371"			
	<u>NOTE</u>			
	All prices/rates to be net, excluding Value Added Tax			
	<u>AREA LIGHTING</u>			
	<u>Supply and installation of SABS approved light fittings as per the specification. complete with lamps. mounted as described including accessories necessary to complete the mounting as specified and are measured separately</u>			
1	4m Steel Pole with brackets and foundation bolts (excluding luminaires), including Delivery to Site and offloading	No	13	
2	"ZELA" 30W LED light fitting complete with lamps, mounted as described including accessories necessities	No	13	
3	Photo cell	No	1	
	<u>Cabling</u>			
	<u>PVC Wiring :</u>			
4	4mm ² x 2core copper cable	m	300	
5	2.5mm ² bare copper earth wire (BCEW)	m	50	
	Carried to Collection			R
	Section No. 4 Bill No 5 - Area Lighting LDPW-B/20151 - BILLS OF QUANTITIES			

**CONSTRUCTION OF NEW LIBRARY
INCLUDING ELECTRICAL, MECHANICAL INSTALLATION
AND ASSOCIATED EXTERNAL WORKS
AT VLEIFONTEIN, VHEMBE DISTRICT**

TESTING AND COMISSIONING

6 Testing and commissioning of the entire medium and low voltage network and area lighting including the provision of all test equipment required and issuing of a certificate of compliance for the installation.

Item

Carried to Collection

R

Section No. 4
Bill No 5 - Area Lighting

LDPW-B/20151 - BILLS OF QUANTITIES

**CONSTRUCTION OF NEW LIBRARY
INCLUDING ELECTRICAL, MECHANICAL INSTALLATION
AND ASSOCIATED EXTERNAL WORKS
AT VLEIFONTEIN, VHEMBE DISTRICT**

Section No. 4

Bill No. 5

Bill No 5 - Area Lighting

COLLECTION

Total Brought Forward from Page No.

Total Brought Forward from Page No.

**Page
No**

329

330

Amount

Carried Forward to Summary of Section No. 4

R

Section No. 4

Bill No 5 - Area Lighting

LDPW-B/20151 - BILLS OF QUANTITIES

**CONSTRUCTION OF NEW LIBRARY
INCLUDING ELECTRICAL, MECHANICAL INSTALLATION
AND ASSOCIATED EXTERNAL WORKS
AT VLEIFONTEIN, VHEMBE DISTRICT**

Item No		Quantity	Rate	Amount
	<u>BILL NO. 6</u>			
	<u>BOOK DETECTION SYSTEM</u>			
	PREAMBLES For preambles refer to "Department of Public Works: Specification of Materials and Method to be used - PW371"			
	<u>NOTE</u>			
	All prices/rates to be net, excluding Value Added Tax			
	<u>PREAMBLES For preambles see "Standard Model Specifications for Building Works PW371/Oct 93"</u>			
1	"Bibliotheca Tattle" or similar and approved by the Principal Agent Tape Gate Single Aisle - Baseplate	No	1	
2	"Bibliotheca Tattle" or similar and approved by the Principal Agent Tape Bookcheck - M942	No	1	
3	"Bibliotheca Tattle" or similar and approved by the Principal Agent Tape strips - B2 1000 per box	No	1	
4	Infra-red Height Detector Beam	No	1	
5	Single Locking Exist Gate with Glass Arm	No	1	
6	Stainless steel helicopter turnstile with screen	No	1	
7	Delivery	No	1	
8	Installation charges	No	1	
	Carried Forward to Summary of Section No. 4			
	Section No. 4			
	Bill No 6 - Book Detection System			
	LDPW-B/20151 - BILLS OF QUANTITIES			
			R	

**CONSTRUCTION OF NEW LIBRARY
INCLUDING ELECTRICAL, MECHANICAL INSTALLATION
AND ASSOCIATED EXTERNAL WORKS
AT VLEIFONTEIN, VHEMBE DISTRICT**

Item No		Quantity	Rate	Amount
	<p><u>BILL NO. 7</u></p> <p><u>ELECTRONIC INSTALLATIONS (CCTV AND NETWORK DATA SYSTEM)</u></p> <p>PREAMBLES For preambles refer to "Department of Public Works: Specification of Materials and Method to be used - PW371"</p>			
	<p><u>NOTE</u></p> <p>All prices/rates to be net, excluding Value Added Tax</p> <p><u>PREAMBLES For preambles see "Standard Model Specifications for Building Works PW371/Oct 93"</u></p> <p><u>SUPPLEMENTARY PREAMBLES</u></p> <p>Installation of an IP CCTV surveillance and Recording System, with 7 days recording (on motion detection).</p> <p>All Cameras and switches are PoE+ compliant.</p> <p>Cameras are inclusive of, vandal & whetherproof housings.</p> <p>CCTV monitoring will be done from the Security Control Room.</p> <p>The system runs on the 10G Fibre LAN</p>			
1	1080p HD-TVI 30m vision cameras dome	No	3	
	Carried to Collection			R
	<p>Section No. 4 Bill No 7 - Electronic installation LDPW-B/20151 - BILLS OF QUANTITIES</p>			

**CONSTRUCTION OF NEW LIBRARY
INCLUDING ELECTRICAL, MECHANICAL INSTALLATION
AND ASSOCIATED EXTERNAL WORKS
AT VLEIFONTEIN, VHEMBE DISTRICT**

2	1080 HD -TVI 360 degree fish eye dome	No	2	
3	1080 HD TVI 40m colour vu vision bullet for outside	No	10	
4	DVR 16 channel	No	1	
5	Hard driver 2TB	No	1	
6	HDMI cable 50m	No	1	
7	Cat6 network cable 80m	No	1	
8	Ups power supply with backup battery	No	1	
9	Universal camera mount enclosure	No	12	
10	Flaxi pipe 25mm	No	30	
11	Connectors	No	32	
12	LCD monitor 32" FULL HD LED	No	1	
13	4U 300 x 200mm collar swing frame wall box cabinet	No	1	
14	LCD wall mount bracket	No	1	
15	Steel wire cable tray	No	17	
16	RG59 +Power -black/100m	No	9	
17	25mm PVC pipes	No	50	
18	25mm PVC adaptor	No	40	
19	25mm PVC coupling	No	30	
20	Labour for new installation and programming		Item	
Carried to Collection				
Section No. 4				
Bill No 7 - Electronic installation				
LDPW-B/20151 - BILLS OF QUANTITIES				
				R

**CONSTRUCTION OF NEW LIBRARY
INCLUDING ELECTRICAL, MECHANICAL INSTALLATION
AND ASSOCIATED EXTERNAL WORKS
AT VLEIFONTEIN, VHEMBE DISTRICT**

Installation of wired data points and wireless access points on power skirting as specified and as indicated on drawings. The system runs on the 10G Fibre LAN

21	Cat6 Network cable 500M	No	2
22	9U CABINET	No	1
23	24 POT NET SWITCH	No	1
24	24 POT PATCH PANEL	No	1
25	BRUSH PANEL	No	1
26	NETWORK POINTS	No	21
27	SKIRTING MOUNT POINT	No	21
28	2M FLYING LEADS	No	21
29	Cat6 RJ45 and boots	No	100
30	i7 HP DESKTOP (computer for saver)	No	1

Carried to Collection

R

Section No. 4
Bill No 7 - Electronic installation
LDPW-B/20151 - BILLS OF QUANTITIES

**CONSTRUCTION OF NEW LIBRARY
INCLUDING ELECTRICAL, MECHANICAL INSTALLATION
AND ASSOCIATED EXTERNAL WORKS
AT VLEIFONTEIN, VHEMBE DISTRICT**

Section No. 4

Bill No. 7

Bill No 7 - Electronic installation

COLLECTION

Total Brought Forward from Page No.

**Page
No**

333

Amount

Total Brought Forward from Page No.

334

Total Brought Forward from Page No.

335

Carried Forward to Summary of Section No. 4

R

Section No. 4

Bill No 7 - Electronic installation

LDPW-B/20151 - BILLS OF QUANTITIES

**CONSTRUCTION OF NEW LIBRARY
INCLUDING ELECTRICAL, MECHANICAL INSTALLATION
AND ASSOCIATED EXTERNAL WORKS
AT VLEIFONTEIN, VHEMBE DISTRICT**

SECTION SUMMARY - Section 4 - Electrical Installations

Bill No		Page No	Amount
1	Bill No 1 - MV Reticulation	313	
2	Bill No 2 - LV Reticulation	316	
3	Bill No 3 - Main Library Building	323	
4	Bill No 4 - Guard House	328	
5	Bill No 5 - Area Lighting	331	
6	Bill No 6 - Book Detection System	332	
7	Bill No 7 - Electronic installation	336	
	Carried to Final Summary		R
	Section No. 4 LDPW-B/20151 - BILLS OF QUANTITIES		

**CONSTRUCTION OF NEW LIBRARY
INCLUDING ELECTRICAL, MECHANICAL INSTALLATION
AND ASSOCIATED EXTERNAL WORKS
AT VLEIFONTEIN, VHEMBE DISTRICT**

Item No		Quantity	Rate	Amount
	<p><u>BILL NO. 1</u></p> <p><u>HVAC INSTALLATION</u></p> <p>PREAMBLES For preambles refer to "Department of Public Works: Specification of Materials and Method to be used - PW371"</p>			
	<p><u>NOTE</u></p> <p>All prices/rates to be net, excluding Value Added Tax</p> <p>PREAMBLES For Preambles refer to "Limpopo Department of Public Works and Infrastructure: Part 3.1 - HVAC Specifications"</p> <p><u>SUPPLEMENTARY PREAMBLES</u></p> <ul style="list-style-type: none"> · Specifications, drawings, etc: Tenderers are referred to the specification and drawings prepared by the Consulting Engineer, for the full descriptions of the following items which are to be read and priced in conjunction with the said specification and drawings · Preliminaries: Any preliminaries that may be required by subcontractors are to be included in the itemised rates or included with the main contractor's preliminaries, as no separate preliminary items have been provided for pricing, nor will such items be accepted · General: Where applicable, the air-conditioning sub-contractor is to ensure that all air-conditioning controls are flush-mounted and positioned adjacent to the respective room's light switch, or as otherwise shown, all necessary chasing of walls and installation of necessary conduits and conduit boxes must be 			
	Carried to Collection			
	<p>Section No. 5 Bill No 1 - HVAC Installation LDPW-B/20151 - BILLS OF QUANTITIES</p>		R	

**CONSTRUCTION OF NEW LIBRARY
INCLUDING ELECTRICAL, MECHANICAL INSTALLATION
AND ASSOCIATED EXTERNAL WORKS
AT VLEIFONTEIN, VHEMBE DISTRICT**

undertaken prior to the plastering of the walls, no sharing of lighting circuitry conduits and conduit boxes will be permitted. All air- conditioning controls are to be wired controls and be labelled to match their respective air- conditioning units. The condensate pipe from the unit shall be connected to the nearest suitable drain point and shall have a fall of not less than 1: 100 and be adequately supported (no bowing of the drains will be entertained). Electrical installation to be completed in accordance with SANS 10142 – 1: 2017 – Edition 2 (South African National Standards: The wiring of premises: Part 1: Low-voltage installations)

- **Ductwork:** Descriptions of ducts shall be deemed to include stiffeners, jointing materials, sealants, couplers in the running length and access/inspection panels in accordance with the specification All Ductwork to be galvanised sheet metal with or without insulation – refer to the BOQ specifications.
- **Air diffusion:** Descriptions of air terminals, grilles, louvres and the like shall be deemed to include necks, frames, supports and flexible connections
- **Fans:** Descriptions of fan assemblies shall be deemed to include supports from the structure, flexible or other connections to ductwork, vibration isolation mountings and airtight inspection doors
- **Sound attenuators:** Descriptions of sound attenuators shall be deemed to include flanged or flexible connections to ducts and supports from the structure
- **Fan coil units, fan air terminals and fan heaters:** Descriptions of fan coil units, fan air terminals and fan heaters shall be deemed to include connection points for water, air and electrical supply, air grilles, dust trays,

Carried to Collection

Section No. 5
Bill No 1 - HVAC Installation
LDPW-B/20151 - BILLS OF QUANTITIES

R

**CONSTRUCTION OF NEW LIBRARY
INCLUDING ELECTRICAL, MECHANICAL INSTALLATION
AND ASSOCIATED EXTERNAL WORKS
AT VLEIFONTEIN, VHEMBE DISTRICT**

condensate trays and vibration isolation mountings. Flexible ducts, flexible hose and connecting cables for connecting these units to each other or to water pipe, and electrical supply are measured separately

- **Piping:** Pipe diameters are nominal internal unless otherwise stated
- **Fixing of pipes:** Unless otherwise stated, descriptions of pipes shall be deemed to include fixing to walls, casting in, building in or suspending not exceeding 1m below suspension level
- **Valves:** Descriptions of valves shall be deemed to include flanged or screwed connections to pipes, reducers, supports, etc.
- **Connections:** All equipment must be supplied complete with operation manuals, and installed/connected to service connection points (by others) within 2m of equipment.

Carried to Collection

Section No. 5
Bill No 1 - HVAC Installation
LDPW-B/20151 - BILLS OF QUANTITIES

R

**CONSTRUCTION OF NEW LIBRARY
INCLUDING ELECTRICAL, MECHANICAL INSTALLATION
AND ASSOCIATED EXTERNAL WORKS
AT VLEIFONTEIN, VHEMBE DISTRICT**

PERSONNEL REQUIRED

Qualified Refrigeration Mechanic will be required to perform all HVAC installations. The Refrigeration Mechanic will be required to have a VALID license to perform installations at the close of tender and during the construction phase of the project.

The practitioner shall be in possession of the following

- **Registration Category -** Category B
- **Registered with SAQCC Gas and the Department of Labour**
- **Trade Test**
- **Proof of Registration -** SAQCC Practitioners Card
- **Registration Title on Card -** Air Conditioning & Refrigeration Practitioner
- **Industry Sector Registration -** Air Conditioning & Refrigeration Plants
- **Refrigerant Group SANS 10147 -** Group A1, A2 & A3
- **Authorised to Issue COC**

Carried to Collection

R

Section No. 5
Bill No 1 - HVAC Installation
LDPW-B/20151 - BILLS OF QUANTITIES

**CONSTRUCTION OF NEW LIBRARY
INCLUDING ELECTRICAL, MECHANICAL INSTALLATION
AND ASSOCIATED EXTERNAL WORKS
AT VLEIFONTEIN, VHEMBE DISTRICT**

Supply, delivery, installation, commissioning and testing of complete HVAC Systems inclusive of indoor and outdoor units, air-handling unit, interconnecting insulated refrigeration piping, pipe tray (cable tray), valves, wiring, refrigerant gas, drain pipes, mounting brackets, insulated ducting (for main system) and un-insulated system (for ablution) including all duct hangers, duct fittings, accessories, dampers and diffusers. All rates provided by contractor should cater for equipment, components, delivery to site, installation, all equipment required during installation, testing and system balancing, commissioning, final testing and training as well as a 12 month maintenance plan with provision for a breakdown maintenance.

1	70kW Ducted Air Handling Unit Inverter with Heat Pump Power Supply: 3Ph/380-415V/50Hz @ 23.6kW Cooling Capacity: 75.0kW Heating Capacity: 70.0kW Refrigeration Gas: R410A	No	1
2	DVMs 5.6 kW Ceiling Cassette (Indoor) Unit Power Supply: 1Ph/220-240V/50Hz @ 32Watts Cooling Capacity: 5.6kW Heating Capacity: 6.3kW Refrigeration Gas: R410A	No	4
3	DVMs 5.6 kW High Wall (Indoor) Unit Power Supply: 1Ph/220-240V/50Hz @ 32Watts Cooling Capacity: 5.6kW Heating Capacity: 6.3kW Refrigeration Gas: R410A	No	1
4	DVMs 28kW Condenser (Outdoor) Unit Power Supply: 3Ph/380-415V/50Hz @ 7.30kW Cooling Capacity: 28.0kW Heating Capacity: 31.5kW Refrigeration Gas: R410A	No	1

Carried to Collection

R

Section No. 5
Bill No 1 - HVAC Installation

LDPW-B/20151 - BILLS OF QUANTITIES

**CONSTRUCTION OF NEW LIBRARY
INCLUDING ELECTRICAL, MECHANICAL INSTALLATION
AND ASSOCIATED EXTERNAL WORKS
AT VLEIFONTEIN, VHEMBE DISTRICT**

5	5.6 kW High Wall Inverter (Indoor and Outdoor) Unit Power Supply: 1Ph/220-240/50Hz @ 1.35kW Cooling Capacity: 5.0kW Refrigeration Gas: R410A	No	1
6	Ø6.35 mm Dia. Copper Insulated Refrigeration Pipe	m	105
7	Ø9.52 mm Copper Insulated Refrigeration Pipe	m	181
8	Ø12.7 mm Copper Insulated Refrigeration Pipe	m	93
9	Ø15.88 mm Copper Insulated Refrigeration Pipe	m	85
10	Copper Refrigerant Pipe fittings, fixtures and harnesses		Item
11	50mm x 50mm Electro-galvanized Steel Wire Cable Tray	m	250
12	50mm x 50mm Electro-galvanized Steel Wire Cable Tray Bends	No	15
13	50mm x 50mm Electro-galvanized Steel Wire Cable Connection Accessories		Item
14	Ø25 mm uPVC Condensate Drain Pipe (Chased into Wall)	m	20
15	R410 Refrigerant Top-up	kg	15
16	Condensate Drain Pump: MDP-G075SP	No	4
17	Wired Remote Controller (Including Wiring): MWR- SH00N	No	4
18	Ø 550mm (Straight) Insulated Galvanized Steel Ducting	m	42
19	Ø 350mm (Straight) Insulated Galvanized Steel Ducting	m	10
20	Ø 300mm (Straight) Insulated Galvanized Steel Ducting	m	75

**CONSTRUCTION OF NEW LIBRARY
INCLUDING ELECTRICAL, MECHANICAL INSTALLATION
AND ASSOCIATED EXTERNAL WORKS
AT VLEIFONTEIN, VHEMBE DISTRICT**

Carried to Collection

R

Section No. 5
Bill No 1 - HVAC Installation

LDPW-B/20151 - BILLS OF QUANTITIES

**CONSTRUCTION OF NEW LIBRARY
INCLUDING ELECTRICAL, MECHANICAL INSTALLATION
AND ASSOCIATED EXTERNAL WORKS
AT VLEIFONTEIN, VHEMBE DISTRICT**

21	Ø 900mm x Ø 900mm to Ø 750mm Reducer	No	2
22	Ø400mm x Ø400mm to Ø 350mm Reducer	No	1
23	Ø 550mm Stop End	No	1
24	Ø 550mm to Ø 550mm by Ø 300mm to Ø 300mm Eccentric Cross	m	7
25	Ø 550mm, 90°Bend	No	2
26	Ø 350mm 90°Bend	No	2
27	Ø 300mm Air Balancing Damper	No	14
28	600 x 600mm (Throat: Ø 200mm)Constant Volume Diffuser	No	14
29	Provision of for Aluminium Door 450 x 450 Grilles	No	10
30	600 x 600mm Return Air Louvered Wall Grille	No	1
31	200mm x 600mm Return Air Louvered Ceiling Grille	No	4
32	Ø 750mm x 1500mm Duct Silencer	No	1
33	Ø 600mm x 1500mm Duct Silencer	No	1
34	Provision for creating Ø 900mm duct openings and making good	No	2
35	Core Drilling of up to Ø 200mm including making good where walls have been drilled	No	6
36	Provision for Duct System Balancing		Item
37	Provision for Testing of entire System		Item

**CONSTRUCTION OF NEW LIBRARY
INCLUDING ELECTRICAL, MECHANICAL INSTALLATION
AND ASSOCIATED EXTERNAL WORKS
AT VLEIFONTEIN, VHEMBE DISTRICT**

Section No. 5
Bill No 1 - HVAC Installation **Carried to Collection**

R

LDPW-B/20151 - BILLS OF QUANTITIES

**CONSTRUCTION OF NEW LIBRARY
INCLUDING ELECTRICAL, MECHANICAL INSTALLATION
AND ASSOCIATED EXTERNAL WORKS
AT VLEIFONTEIN, VHEMBE DISTRICT**

38	Provision for Training of Limpopo DSAC Library Staff	No	6		
39	Provision for Commissioning and Testing by Original Equipment Manufacturer	No	4		
40	Provision for Certificate of Compliance by Registered Refrigeration Mechanic	No	2		
41	Provision for Bi Annual Preventative Maintenance of Entire System inclusive of 1 x Registered Refrigeration Mechanic's call out fee to site for up to 24 working hours 1 x non-Registered Refrigeration Mechanic's call out fee to site for up to 24 working hours Refrigeration top up, Tooling, Hoists and Equipment required to perform maintenance Safety related documentation Refer to Technical Specifications for Maintenance Specifications for envisioned preventative maintenance	No	2		
42	Provision for 36 Month Warranty from OEM on Entire HVAC System Warranty should cover, Call out fee for OEM to perform assessment, Provision for replacing any component or equipment of the HVAC System *Refer to Technical Specifications for Warranty Requirements	No	3		
	<u>Ablution HVAC System</u>				
43	Ø 250mm (Straight) Uninsulated Galvanized Steel Ducting	m	5		
44	Ø 200mm (Straight) Uninsulated Galvanized Steel Ducting	m	3		
45	Ø 150mm (Straight) Uninsulated Galvanized Steel Ducting	m	4		
46	Ø 100mm (Straight) Uninsulated Galvanized Steel Ducting	m	2		
	Carried to Collection				R
	Section No. 5 Bill No 1 - HVAC Installation LDPW-B/20151 - BILLS OF QUANTITIES				

**CONSTRUCTION OF NEW LIBRARY
INCLUDING ELECTRICAL, MECHANICAL INSTALLATION
AND ASSOCIATED EXTERNAL WORKS
AT VLEIFONTEIN, VHEMBE DISTRICT**

47	Ø 100mm (Straight) Uninsulated Flexible Ducting	m	8		
48	Ø 300mm x Ø 300mm to Ø 250mm Reducer	No	1		
49	Ø 250mm to Ø 300mm Reducer	No	4		
50	Ø 250mm to Ø 200mm Reducer	No	1		
51	Ø 200mm to Ø 150mm Reducer	No	4		
52	Ø 150mm to Ø 100mm Reducer	No	4		
53	Ø 250mm, 90°Bend	No	3		
54	Ø 150mm, 90°Bend	No	1		
55	Ø 100mm Uninsulated Flexible Duct Connector Kit	No	4		
56	150mm x 150mm Extraction Valve with Ø 100mm Neck and Duct Connector Kit	No	4		
57	Ø 300 x 300mm Side Wall Louvered Air Grille	No	1		
58	Ø 250mm Duct Silencer	No	1		
59	Provision for Testing of entire System		Item		
60	Provision for Training of Limpopo DSAC Library Staff	No	6		
61	450L/s @ 150pa In-line Duct Extraction Fan with Multiple Occupancy Detection System	No	1		
62	75L/s @ 150pa Wall/Window Mounted Extraction Fan with Occupancy Detection System	No	1		

**CONSTRUCTION OF NEW LIBRARY
INCLUDING ELECTRICAL, MECHANICAL INSTALLATION
AND ASSOCIATED EXTERNAL WORKS
AT VLEIFONTEIN, VHEMBE DISTRICT**

Carried to Collection

R

Section No. 5
Bill No 1 - HVAC Installation
LDPW-B/20151 - BILLS OF QUANTITIES

**CONSTRUCTION OF NEW LIBRARY
INCLUDING ELECTRICAL, MECHANICAL INSTALLATION
AND ASSOCIATED EXTERNAL WORKS
AT VLEIFONTEIN, VHEMBE DISTRICT**

Section No. 5

Bill No. 1

Bill No 1 - HVAC Installation

COLLECTION

Total Brought Forward from Page No.
Total Brought Forward from Page No.
Total Brought Forward from Page No.
Total Brought Forward from Page No.
Total Brought Forward from Page No.
Total Brought Forward from Page No.
Total Brought Forward from Page No.
Total Brought Forward from Page No.
Total Brought Forward from Page No.

**Page
No**

338
339
340
341
342
343
344
345
346

Amount

Carried Forward to Summary of Section No. 5

R

Section No. 5
Bill No 1 - HVAC Installation
LDPW-B/20151 - BILLS OF QUANTITIES

**CONSTRUCTION OF NEW LIBRARY
INCLUDING ELECTRICAL, MECHANICAL INSTALLATION
AND ASSOCIATED EXTERNAL WORKS
AT VLEIFONTEIN, VHEMBE DISTRICT**

Item No		Quantity	Rate	Amount
	<p><u>BILL NO. 2</u></p> <p>PREAMBLES For preambles refer to "Department of Public Works: Specification of Materials and Method to be used - PW371"</p>			
	<p><u>NOTE</u></p> <p>All prices/rates to be net, excluding Value Added Tax</p> <p>Tenderers are referred to the departmental specification " Part 3.2 - Fire Protection Specifications" and drawings prepared by the Consulting Engineer, annexed to these Bills of Quantities, for the full descriptions of the following items which are to be read and priced in conjunction with the said specification and drawings</p> <p><u>SUPPLEMENTARY PREAMBLES</u></p> <ul style="list-style-type: none"> • Preliminaries: Any preliminaries that may be required by subcontractors are to be included in the itemised rates or included with the main contractor's preliminaries, as no separate preliminary items have been provided for pricing, nor will such items be accepted • Connections: All equipment must be supplied complete with operation manuals, and installed/connected to service connection points (by others) within 2m of equipment. <p>PERSONNEL REQUIRED</p> <p>Qualified Fire Detection Technician will be required to perform all Fire Detection installations. The Fire Detection Technician will be required to have a VALID license to perform installations at the close of tender and during the construction phase of the project.</p> <p>The practitioner shall be in possession of the following:</p>			
	Carried to Collection			
	<p>Section No. 5 Bill No 2 - Fire Detection and Protection LDPW-B/20151 - BILLS OF QUANTITIES</p>		R	

**CONSTRUCTION OF NEW LIBRARY
INCLUDING ELECTRICAL, MECHANICAL INSTALLATION
AND ASSOCIATED EXTERNAL WORKS
AT VLEIFONTEIN, VHEMBE DISTRICT**

- **Registration Category -** SAQCC Fire
1475 Technician
- **Registered with SAQCC Fire**
- **Proof of Registration -** SAQCC 1475
Identity Card
- **Registration Title on Card -** Installer
of Fire Detection System
- **Industry Sector Registration -** Air
Conditioning & Refrigeration Plants
- **Industrial Sector Registration -** Fire
Detection
- **Fire Detection Types -**
Commercial/Residential

FIRE DETECTION, SUPPRESSION AND PROTECTION

Note:

Supply, delivery, installation, commissioning and testing of complete Fire Protection Systems inclusive of all Fire Detection Systems, Fire Hose Reels, Fire Extinguishers, Fire Blankets, Escape Route Signs. All rates should include. All rates provided by contractor should cater for equipment, components, delivery to site, installation, all equipment required during installation, testing and system balancing, commissioning, final testing and training as well as a 12 month maintenance plan with provision for a breakdown maintenance.

Carried to Collection

Section No. 5
Bill No 2 - Fire Detection and Protection
LDPW-B/20151 - BILLS OF QUANTITIES

R

**CONSTRUCTION OF NEW LIBRARY
INCLUDING ELECTRICAL, MECHANICAL INSTALLATION
AND ASSOCIATED EXTERNAL WORKS
AT VLEIFONTEIN, VHEMBE DISTRICT**

Fire Detection System

1	Fire Control Panel, Model: TC5100 Intelligent (Addressable) Panel (or equivalent if approved), Devices Per Zone: 126 @ 1 Zone with 2 Sounders @2 x 24V / 0.3A Fuse, Power: 220-240V/1Ph/50Hz with 1 x 12V/7Ah Battery, Dimensions: 340 x 340 x 85mm (HxWxD)	No	1
2	LiFePo4 Rechargeable Battery Capacity: 7Ah Voltage: 24V	No	2
3	Fire Detector (Addressable) Multi-Sensor with Standard Base: (Smoke and Heat) Protection Area: 120m ² Wire Size: 0.4mm ² - 2.0mm ² Dimensions: Ø105mm x 48mm(H)"	No	14
4	Manual Call Point (Addressable) Break-Glass Sensor with Standard Base: Wire Size: 0.4mm - 2.0mm Dimensions: 90mm x 90mm(H)	No	6
5	Audible and Visual Strobe (Addressable) Sounder Beacon with Base (Dual Function: Sound and Visual) Frequency: 400 - 2,850Hz Power: 20W, 80mA, 220-240V/1Ph/50Hz Dimensions: Ø97.5mm x 104mm	No	2
6	1mm ² x 2 core, PH30 Fire Alarm Cable	m	980
7	Ø20mm Externally Threaded Rigid Galvanised Steel Conducting placed in position for casting in concrete, surface bed or screed, for building or chased into brickwork and for surface mounting in ceiling space including flexible bends, threaded coupling joints and draw wires (SANS 62 Flared and Threaded Pipe)	m	735

Carried to Collection

R

Section No. 5
Bill No 2 - Fire Detection and Protection

**CONSTRUCTION OF NEW LIBRARY
INCLUDING ELECTRICAL, MECHANICAL INSTALLATION
AND ASSOCIATED EXTERNAL WORKS
AT VLEIFONTEIN, VHEMBE DISTRICT**

LDPW-B/20151 - BILLS OF QUANTITIES

**CONSTRUCTION OF NEW LIBRARY
INCLUDING ELECTRICAL, MECHANICAL INSTALLATION
AND ASSOCIATED EXTERNAL WORKS
AT VLEIFONTEIN, VHEMBE DISTRICT**

8	Ø20mm x 500mm Externally Threaded Flexible Galvanised Steel Bend (SANS 14 / EN 10242 or BS143)	No	35		
9	Ø20mm x 500mm Externally Threaded Ridged Galvanised Steel Bend (SANS 14 / EN 10242 or BS143)	No	25		
10	Ø20mm Internally Threaded Coupling Joint/Socket (SANS 14 / EN 10242 or BS143)	No	305		
11	Ø20mm Galvanised Steel Conducting, Rubber Lined Wall Pipe Clamps complete with Screws and Nuts/Bolts (where required)	m	795		
12	50mm Anti-Corrosion Denso-Tape	m	480		
13	Core Drilling of up to Ø 50mm including making good where walls have been drilled	No	30		
14	Testing of entire System		Item		
15	Provision for Training of Limpopo DSAC Library Staff	No	6		
16	Provision for Commissioning	No	4		
17	Provision for Certificate of Compliance by Registered Refrigeration Mechanic	No	2		
18	Provision for Bi Annual Preventative Maintenance of Entire System inclusive of 1 x Registered Fire Detection Technician call out fee to site for up to 4 working hours Tooling, Hoists and Equipment required to perform maintenance Refer to Technical Specifications for Maintenance Specifications for envisioned preventative maintenance	No	2		

**CONSTRUCTION OF NEW LIBRARY
INCLUDING ELECTRICAL, MECHANICAL INSTALLATION
AND ASSOCIATED EXTERNAL WORKS
AT VLEIFONTEIN, VHEMBE DISTRICT**

Carried to Collection

Section No. 5
Bill No 2 - Fire Detection and Protection
LDPW-B/20151 - BILLS OF QUANTITIES

**CONSTRUCTION OF NEW LIBRARY
INCLUDING ELECTRICAL, MECHANICAL INSTALLATION
AND ASSOCIATED EXTERNAL WORKS
AT VLEIFONTEIN, VHEMBE DISTRICT**

19	Provision for 36 Month Warranty from OEM on Entire Fire Detection System Warranty should cover, Call out fee for OEM to perform assessment, Provision for replacing any component or equipment of the Fire Detection System, *Refer to Technical Specifications for Warranty Requirements	P/Mon	36		
<u>Fire Protection System</u>					
20	Centrifugal Pump Inlet: Ø63 - 80mm Outlet: Ø50 - 63mm Pressure: 400kPa Flowrate: 1 L/s Complete with Baseplate and vibration dampers Power Supply: 415V, 3 Phase, 50Hz	No	1		
21	Ø63 - 80mm Threaded Strainer	No	1		
22	Ø63 - 80mm Threaded Isolation Valve	No	1		
23	Bottom Entry Analogue Positive Pressure Gauge Pressure Range: 1 - 9 Bar Glycerine Filled	No	1		
24	Ø50 - 63mm Threaded Isolation Valve	No	2		
25	Ø50 - 63mm Non-Return Valve	No	2		
26	Upright Pressure Tank Capacity: 100 Litre Material: 304 Stainless Steel Max Pressure: 10 bar Connector: 1 Stainless Steel Inlet Thread Membrane: Fixed Butyl Rubber Membrane Replaceable Type	No	1		
Carried to Collection					R

**CONSTRUCTION OF NEW LIBRARY
INCLUDING ELECTRICAL, MECHANICAL INSTALLATION
AND ASSOCIATED EXTERNAL WORKS
AT VLEIFONTEIN, VHEMBE DISTRICT**

Section No. 5
Bill No 2 - Fire Detection and Protection
LDPW-B/20151 - BILLS OF QUANTITIES

**CONSTRUCTION OF NEW LIBRARY
INCLUDING ELECTRICAL, MECHANICAL INSTALLATION
AND ASSOCIATED EXTERNAL WORKS
AT VLEIFONTEIN, VHEMBE DISTRICT**

27	Automatic Pressure Switch Max Power: 15kw Starting Pressure: 2.0 Bar Maximum working Pressure: 10 Bar Connection: Ø50 - 63mm Protection Rating: IP 65 Maximum Temperature Rating: 60°C Automatic Start Switch Maximum Current: 25 Amp Power Supply: 415V, 3 Phase, 50Hz	No	1		
28	Ø80mm Galvanized Steel Pipe	m	90		
29	Ø63mm Galvanized Steel Pipe	m	80		
30	Ø50mm Galvanized Steel Pipe	m	80		
31	Ø80mm Galvanized Steel Pipe Connections		Item		
32	Ø63mm Galvanized Steel Pipe Connections		Item		
33	Ø50mm Galvanized Steel Pipe Connections		Item		
34	Ø50mm PN16 HDPE Pipe	m	180		
35	Ø32mm PN16 HDPE Pipe	m	60		
36	30m Swing Type Fire Hose Reel as per SANS 543 Complete with Pressure Guage, Isolation Valve and Aluminium Nozzel	No	2		
37	9.0kg DCP Fire Extinguisher	No	8		

**CONSTRUCTION OF NEW LIBRARY
INCLUDING ELECTRICAL, MECHANICAL INSTALLATION
AND ASSOCIATED EXTERNAL WORKS
AT VLEIFONTEIN, VHEMBE DISTRICT**

Carried to Collection

Section No. 5
Bill No 2 - Fire Detection and Protection
LDPW-B/20151 - BILLS OF QUANTITIES

**CONSTRUCTION OF NEW LIBRARY
INCLUDING ELECTRICAL, MECHANICAL INSTALLATION
AND ASSOCIATED EXTERNAL WORKS
AT VLEIFONTEIN, VHEMBE DISTRICT**

38	Fire Blanket Size: 1.8 x 1.8m Weight (min): 430 gr/m ² Weight: 1.94kg Ignition Time: 13 min Max temp: 550°C	No	2		
39	Complete First Aid Box	No	1		
40	SANS 1186 Phosphorescent Fire Signage, Escape Routes and Hazard Warnings	No	32		
Carried to Collection					R
Section No. 5 Bill No 2 - Fire Detection and Protection LDPW-B/20151 - BILLS OF QUANTITIES					

**CONSTRUCTION OF NEW LIBRARY
INCLUDING ELECTRICAL, MECHANICAL INSTALLATION
AND ASSOCIATED EXTERNAL WORKS
AT VLEIFONTEIN, VHEMBE DISTRICT**

Section No. 5

Bill No. 2

Bill No 2 - Fire Detection and Protection

COLLECTION

Total Brought Forward from Page No.

**Page
No**

348

Amount

Total Brought Forward from Page No.

349

Total Brought Forward from Page No.

350

Total Brought Forward from Page No.

351

Total Brought Forward from Page No.

352

Total Brought Forward from Page No.

353

Total Brought Forward from Page No.

354

Carried Forward to Summary of Section No. 5

R

Section No. 5

Bill No 2 - Fire Detection and Protection

LDPW-B/20151 - BILLS OF QUANTITIES

**CONSTRUCTION OF NEW LIBRARY
INCLUDING ELECTRICAL, MECHANICAL INSTALLATION
AND ASSOCIATED EXTERNAL WORKS
AT VLEIFONTEIN, VHEMBE DISTRICT**

Item No		Quantity	Rate	Amount
	<p><u>BILL NO. 4</u></p> <p>PREAMBLES For preambles refer to "Department of Public Works: Specification of Materials and Method to be used - PW371"</p>			
	<p><u>NOTE</u></p> <p>All prices/rates to be net, excluding Value Added Tax</p> <p><u>SUPPLEMENTARY PREAMBLES</u></p> <p>Excavations</p> <p>Prices for excavations must include for necessary staging for risk of collapse of excavation side.</p> <p>Compacting</p> <p>Filling for all types of prices described as "under solid floors, etc" shall be done with approved backfilling and compacted to 93% Mod. AASHTO density, unless otherwise described</p> <p>Testing</p> <p>Descriptions for the testing of plumbing and drainage installations shall be deemed to cater for all testing apparatus, labour, etc. and shall be done strictly as directed by and in accordance to the Principal Agent's instructions, including for retesting after taking out and making good all defective work to his entire satisfaction</p>			
	<p>Carried to Collection</p>		R	
	<p>Section No. 5 Bill No 3 - Wet Services LDPW-B/20151 - BILLS OF QUANTITIES</p>			

**CONSTRUCTION OF NEW LIBRARY
INCLUDING ELECTRICAL, MECHANICAL INSTALLATION
AND ASSOCIATED EXTERNAL WORKS
AT VLEIFONTEIN, VHEMBE DISTRICT**

Vitrified clay pipes:

Pipes shall rest on solid ground and, where necessary, pockets of sufficient size shall be cut around joints to enable the jointing to be properly performed or, alternatively, pipes shall be bedded full length on and including unreinforced concrete laid in a semi-dry state immediately before pipes are laid

Sewer and drainage pipes and fittings shall be jointed and sealed with butyl rubber rings

uPVC pipes and fittings

Sewer and drainage pipes and fittings shall be jointed and sealed with butyl rubber rings

Soil, waste and vent pipe fittings shall be solvent weld jointed

uPVC pressure pipes and fittings

Pipes for water supply shall be of the class stated

Pipes of 40mm diameter and smaller shall be plain ended with solvent welded uPVC loose sockets and fittings

Copper pipes

Pipes shall be hard drawn and half hard pipes of the class stated. Class 0 (thin walled hard drawn pipes) shall not be bent. Class 1 (thin half hard), Class 2 (half hard) and Class 3 (heavy walled half-hard) pipes shall only be bent with benders with inner and outer formers. Fittings for copper waste, vent and anti siphon pipes, capillary solder fittings and compression fittings shall be "Cobra Watertech" type. Capillary solder fittings shall comply with ISO 2016. Only compression fittings shall be used in walls or ground.

Carried to Collection

Section No. 5

Bill No 3 - Wet Services

LDPW-B/20151 - BILLS OF QUANTITIES

R

**CONSTRUCTION OF NEW LIBRARY
INCLUDING ELECTRICAL, MECHANICAL INSTALLATION
AND ASSOCIATED EXTERNAL WORKS
AT VLEIFONTEIN, VHEMBE DISTRICT**

Reducing fittings

Where fittings have reducing ends or branches they are described as "reducing". In the case of pipes with diameters not exceeding 60mm only the largest end or branch size is given. Should the Contractor wish to use other fittings and bushes or reducers, he may do so on the understanding that no claim in this regard will be entertained. In the case of pipes with diameters exceeding 60mm all sizes are given and no claim for extra bushes, reducers will be entertained.

Excavations

No claim for extra rock excavation will be entertained unless the Contractor has timeously notified the Quantity Surveyor, thereof prior to backfilling, in writing

"Soft rock" and "Hard rock" shall be as defined in "Earthworks"

Laying, Backfilling, Bedding, etc. of Pipes

Pipes shall be laid and bedded and trenches shall be carefully backfilled in accordance with the manufacturer's instructions

Where no manufacturer's instructions exist pipes shall be laid in accordance with clauses 5.1 and 5.2 of each of the following: SABS 1200L : Medium Pressure Pipes
LD : Sewers LE : Stormwater Drainage

Pipes trenches, etc. shall be backfilled in accordance with Clauses 3, 5.5, 5.6, 5.7 and 7 of SABS 1200DB: Earthworks (Pipe Trenches)

Pipes shall be bedded in accordance with Clause 3.1 to 3.4.1, 5.1 to 5.3 and 7 of SABS 1200LB : Bedding (Pipes)

Unless otherwise described bedding of rigid pipes shall be Class B bedding

Carried to Collection

Section No. 5
Bill No 3 - Wet Services
LDPW-B/20151 - BILLS OF QUANTITIES

R

**CONSTRUCTION OF NEW LIBRARY
INCLUDING ELECTRICAL, MECHANICAL INSTALLATION
AND ASSOCIATED EXTERNAL WORKS
AT VLEIFONTEIN, VHEMBE DISTRICT**

Flush pans

Flush pans shall have straight or side outlets and "P" or "S" traps as necessary

Waste unions

Description of waste unions shall be deemed to include rubber or vulcanite plugs and chains

WATER SERVICES

Water Supply Piping

Supply, delivery, installation, commissioning and testing of Potable Water Supply Piping

1	Ø20mm Ball Valve	No	2
2	Ø20mm Strainer	No	2
3	Ø20mm Non- Return Valve	No	2
4	Ø20mm Pressure Regulator	No	2
5	Ø15mm Braided Flexible Hose with Ball Valve	No	20
6	Ø20mm Class 2 Copper Piping	m	150
7	Ø15mm Class 2 Copper Piping	m	320
8	Ø20mm Class 2 Copper Piping Capillary Fittings		Item
9	Ø15mm Class 2 Copper Piping Capillary Fittings		Item

Grey Water

**CONSTRUCTION OF NEW LIBRARY
INCLUDING ELECTRICAL, MECHANICAL INSTALLATION
AND ASSOCIATED EXTERNAL WORKS
AT VLEIFONTEIN, VHEMBE DISTRICT**

Carried to Collection

Section No. 5
Bill No 3 - Wet Services
LDPW-B/20151 - BILLS OF QUANTITIES

**CONSTRUCTION OF NEW LIBRARY
INCLUDING ELECTRICAL, MECHANICAL INSTALLATION
AND ASSOCIATED EXTERNAL WORKS
AT VLEIFONTEIN, VHEMBE DISTRICT**

Supply, delivery, installation, commissioning and testing of Grey Water Drainage Piping

10	Ø50mm µPVC Piping (Class 34)	m	50
11	Ø110mm µPVC Piping (Class 34)	m	180
12	Ø50mm µPVC Piping (Class 34) Fittings		Item
13	Ø110mm µPVC Piping (Class 34) Fittings		Item

Water Heating

Supply, delivery, installation, commissioning and testing of Water Heating System

14	Hydro-boil Capacity: 10L Power Supply: 240V/1Pha/50Hz	No	1
----	---	----	---

Water Purification

Supply, delivery, installation, commissioning and testing of Water Purification System

15	Industrial Reverse Osmosis System Model: BLPRO-1500, Membrane: 2 x 4040 Capacity: 150l/hr Power Supply: 240V/1Pha/50Hz	No	1
----	--	----	---

Borehole Installations

Borehole Siting, Verification, Drilling, Equipping, Testing of Water Quality and Flowrate, Commissioning and Provision of COC

16	Geo-Hydro Borehole Drilling Siting and Monitoring	No	1
17	Borehole drilling (Air Percussion drilling) including steel casing of Borehole	No	300

Section No. 5
Bill No 3 - Wet Services

**CONSTRUCTION OF NEW LIBRARY
INCLUDING ELECTRICAL, MECHANICAL INSTALLATION
AND ASSOCIATED EXTERNAL WORKS
AT VLEIFONTEIN, VHEMBE DISTRICT**

Carried to Collection

R

LDPW-B/20151 - BILLS OF QUANTITIES

**CONSTRUCTION OF NEW LIBRARY
INCLUDING ELECTRICAL, MECHANICAL INSTALLATION
AND ASSOCIATED EXTERNAL WORKS
AT VLEIFONTEIN, VHEMBE DISTRICT**

18	Borehole Yield Testing (24 Hr Constant discharge test)		Item
19	Laboratory water analysis (Physical, Biological and Chemical Analysis)		Item
20	Hydro-geological Report Signed off by Professional Certified Natural Scientist: Geo-Hydrologist		Item
21	Borehole Pump Type: Submersible Max Flowrate: 2L/s Min Head: 150m Power Supply: 415V/3Ph/50Hz Complete with Timer, Grey Box, Outlet Piping, Valves, Pressure Guages, Water Meter and all pipe work, accessories and items required to ensure borehole is fully functional		Item
22	Automatic Control Box including Borehole Water Level Sensors and Sectional Steel Tank Level Senors		Item
23	16mm ² , 3 Core AWG Power Supply Cable	m	250
24	2.5mm ² , Core AWG Power Supply Cable	m	250

Section No. 5
Bill No 3 - Wet Services

**CONSTRUCTION OF NEW LIBRARY
INCLUDING ELECTRICAL, MECHANICAL INSTALLATION
AND ASSOCIATED EXTERNAL WORKS
AT VLEIFONTEIN, VHEMBE DISTRICT**

<p style="text-align: center;">Carried to Collection</p> <p>LDPW-B/20151 - BILLS OF QUANTITIES</p>			R
--	--	--	----------

**CONSTRUCTION OF NEW LIBRARY
INCLUDING ELECTRICAL, MECHANICAL INSTALLATION
AND ASSOCIATED EXTERNAL WORKS
AT VLEIFONTEIN, VHEMBE DISTRICT**

Section No. 5

Bill No. 3

Bill No 3 - Wet Services

COLLECTION

Total Brought Forward from Page No.

**Page
No**

356

Amount

Total Brought Forward from Page No.

357

Total Brought Forward from Page No.

358

Total Brought Forward from Page No.

359

Total Brought Forward from Page No.

360

Total Brought Forward from Page No.

361

Carried Forward to Summary of Section No. 5

R

Section No. 5

Bill No 3 - Wet Services

LDPW-B/20151 - BILLS OF QUANTITIES

**CONSTRUCTION OF NEW LIBRARY
INCLUDING ELECTRICAL, MECHANICAL INSTALLATION
AND ASSOCIATED EXTERNAL WORKS
AT VLEIFONTEIN, VHEMBE DISTRICT**

SECTION SUMMARY - Section 5 - Mechanical Works

Bill No		Page No	Amount
1	Bill No 1 - HVAC Installation	347	
2	Bill No 2 - Fire Detection and Protection	355	
3	Bill No 3 - Wet Services	362	
Carried to Final Summary			
Section No. 5			
LDPW-B/20151 - BILLS OF QUANTITIES			
			R

**CONSTRUCTION OF NEW LIBRARY
INCLUDING ELECTRICAL, MECHANICAL INSTALLATION
AND ASSOCIATED EXTERNAL WORKS
AT VLEIFONTEIN, VHEMBE DISTRICT**

Item No	Quantity	Rate	Amount
<u>SECTION NO 6</u>			
<u>BILL NO. 1</u>			
<u>OCCUPATIONAL HEALTH & SAFETY (PROVISIONAL)</u>			
<u>PREAMBLES</u>			
All prices/rates to be net, excluding Value Added Tax			
<u>SUPPLEMENTARY PREAMBLES</u>			
<u>Disaster Management Act: Regulations: Alert during Corona virus COVID-19 lock down</u>			
<p>i) The following is an extraction from the original gazetted Alert regulations. Amendments as gazetted in Gazette are indicated as follows - changes. Amendments as gazetted as follows - changes as detailed in the website indicated hereunder https://www.gov.za/Coronavirus</p> <p>Occupational Health and Safety Act of the Construction Regulation (2014), it is the Client's obligation that the cost for health & safety has been provided for by the Contractor, before appointment. Due to the Disaster Management Act and Regulation (Act nr. 57 of 2002)</p> <p>On behalf of the Client, we require the following health & safety to be included by the Principal Contractor for OHS & COVID-19 be made very clear that these are just some of the health & safety be included in the tender pricing. It is duty of the Principal Contractor to ensure that all aspects of the Occupational health & safety Act 85/1993 and construction regulation and additional costs in terms of COVID-19 Legal Requirements are costed for.</p>			
Carried to Collection			R
Section No. 6 Bill No 1 - Occupational Health and Safety LDPW-B/20151 - BILLS OF QUANTITIES			

**CONSTRUCTION OF NEW LIBRARY
INCLUDING ELECTRICAL, MECHANICAL INSTALLATION
AND ASSOCIATED EXTERNAL WORKS
AT VLEIFONTEIN, VHEMBE DISTRICT**

**SUPPLY OF ALL ITEMS OF PERSONAL
PROTECTIVE CLOTHING/EQUIPMENT & ENSURE
USE THEREOF FOR FULL COMPLIANCE
(INCLUDING COVID-19 COMPLIANCE PPE)**

1	Overalls (2 x Sets per person)		Item		
2	Safety goggles: COVID-19 testing personnel (2 x Sets per person)		Item		
3	Full face shields for First Aider & Screening officer		Item		
4	3 Layered cloth masks (2 x per person)		Item		
5	"FFP2" Dust Mask		Item		
6	Ear plugs (2 x Sets per person)		Item		
7	Hand gloves (2 x Sets per person)		Item		
8	Personal fall arrest and rescue equipment with and including life lines and associated equipment's		Item		
9	Safety harnesses		Item		
10	Scaffolding		Item		
<u>BARRICADING: SUPPLY AND INSTALL, INCLUDING REMOVAL UPON COMPLETION TO ENSURE FULL COMPLIANCE TO LEGISLATION (CR 13 EXCAVATIONS)</u>					
11	Rigid type barricading (open trenches) orange netting - droppers 2.2m high and at 2m intervals	m		200	
12	Temporary galvanised mesh fence 1.8m high barricading along perimeter of excavated	m		200	
13	Contractor site camp facility fence 1.8m bonox fence (80% green shade net)	m		80	
14	Extra over for vehicular gate	No		1	

Carried to Collection

R

Section No. 6

**CONSTRUCTION OF NEW LIBRARY
INCLUDING ELECTRICAL, MECHANICAL INSTALLATION
AND ASSOCIATED EXTERNAL WORKS
AT VLEIFONTEIN, VHEMBE DISTRICT**

Bill No 1 - Occupational Health and Safety
LDPW-B/20151 - BILLS OF QUANTITIES

**CONSTRUCTION OF NEW LIBRARY
INCLUDING ELECTRICAL, MECHANICAL INSTALLATION
AND ASSOCIATED EXTERNAL WORKS
AT VLEIFONTEIN, VHEMBE DISTRICT**

15	Extra over for pedestrian gate	No	1		
16	Fencing of waste disposal area: Green netting 1.8m high at 80% green shade net bonox fence	m	80		
<u>OCCUPATIONAL HEALTH AND SAFETY ADMINISTRATION</u>					
17	Development of a Site Specific Health and Safety Plan, Hazard and Risk Assessment by a Competent qualified person, including Risks for COVID-19 to the approval of the Principal Agent.			Item	
18	Development of Fall Protection and Rescue Plan by a competent and qualified Fall Protection Plan Developer to the approval of the Principal Agent			Item	
19	Competent and qualified Occupational Health and Safety Officer SACPCMP registered (Full time on site)	Month	12		
20	Health and Safety Training			Item	
21	First Aider (Level 1)			Item	
22	SHE REP training			Item	
23	Working at heights training			Item	
24	Covid-19 Compliance Office Training			Item	
25	Scaffold erection/inspection			Item	
<u>EMPLOYEES MEDICALS: CR 7(1)(G)</u>					
26	Medical from Occupational Practitioner on annexure 3 format - including COVID-19 medical questionnaire			Item	
<u>ACCESS CONTROL: COVID-19 SCREENING</u>					
27	Screening officer full time access/COVID-19	Month	12		
28	Security officer full time access control	Month	12		
Carried to Collection					
				R	
Section No. 6 Bill No 1 - Occupational Health and Safety					

**CONSTRUCTION OF NEW LIBRARY
INCLUDING ELECTRICAL, MECHANICAL INSTALLATION
AND ASSOCIATED EXTERNAL WORKS
AT VLEIFONTEIN, VHEMBE DISTRICT**

LDPW-B/20151 - BILLS OF QUANTITIES

**CONSTRUCTION OF NEW LIBRARY
INCLUDING ELECTRICAL, MECHANICAL INSTALLATION
AND ASSOCIATED EXTERNAL WORKS
AT VLEIFONTEIN, VHEMBE DISTRICT**

29	Tables		Item		
30	Chairs		Item		
31	Stationery		Item		
32	Thermometer	No	2		
33	Hand sanitizer access point	No	4		
34	Isolation area (4 x 3m) at access control point: Shade net structure well ventilated with signage	No	1		
<u>WORKERS WELFARE FACILITIES</u>					
35	Toilet facilities (chemical) 1:30 1 x each gender with personnel hand sanitizer for each toilet and a wash hand basin including maintenance.	No	2		
36	Shade netting staggered eating area structure	No	1		
37	Chairs (Social distancing of 1.5m apart)		Item		
38	Tables		Item		
39	20 Litre 2 x bins at eating area (Biological waster)	No	2		
40	Wash hand basin including pump action soap dispenser and maintenance thereof	No	1		
41	Paper towel dispenser including maintenance thereof	No	12		
42	Changing area including lockers for each gender		Item		
<u>OTHER EQUIPMENT: COVID-19 COMPLIANCE</u>					
43	Hand sanitizer (70% alcohol based) and refills	I	50		
44	Disinfectant applied by knapsack sprayer for tools, offices, screening area for the construction period		Item		
45	Hand wash point at working area		Item		
Carried to Collection					R
Section No. 6 Bill No 1 - Occupational Health and Safety LDPW-B/20151 - BILLS OF QUANTITIES					

**CONSTRUCTION OF NEW LIBRARY
INCLUDING ELECTRICAL, MECHANICAL INSTALLATION
AND ASSOCIATED EXTERNAL WORKS
AT VLEIFONTEIN, VHEMBE DISTRICT**

46	First Aid kits	No	2	
47	20L Waste bins (biological waste, domestic waste) lined with plastic bags (waste management)	No	4	
48	Fire extinguishers (9Kg) to be place at office, work area(s), eating area, storage area(s), etc. CR29		Item	
49	Hazardous chemical cage: lockable with signage and well ventilated to the approval of the Principal Agent. CR25		Item	
<u>SAFETY SIGNAGE INCLUDING COVID-19 AWARENESS</u>				
50	Scaffolding tags (Red/Green)		Item	
51	Deep excavations		Item	
52	Covid-19 signage (Awareness)		Item	
53	Directional signage emergency routes		Item	
54	Emergency assembly point		Item	
55	Site office signage		Item	
56	Notice Board		Item	
57	Name Tags		Item	
58	Induction stickers for hard hats		Item	
Carried to Collection				
Section No. 6				
Bill No 1 - Occupational Health and Safety				
LDPW-B/20151 - BILLS OF QUANTITIES				
				R

**CONSTRUCTION OF NEW LIBRARY
INCLUDING ELECTRICAL, MECHANICAL INSTALLATION
AND ASSOCIATED EXTERNAL WORKS
AT VLEIFONTEIN, VHEMBE DISTRICT**

Section No. 6

Bill No. 1

Bill No 1 - Occupational Health and Safety

COLLECTION

Total Brought Forward from Page No.

**Page
No**

364

Amount

Total Brought Forward from Page No.

365

Total Brought Forward from Page No.

366

Total Brought Forward from Page No.

367

Total Brought Forward from Page No.

368

Carried to Final Summary

R

Section No. 6

Bill No 1 - Occupational Health and Safety

LDPW-B/20151 - BILLS OF QUANTITIES

**CONSTRUCTION OF NEW LIBRARY
INCLUDING ELECTRICAL, MECHANICAL INSTALLATION
AND ASSOCIATED EXTERNAL WORKS
AT VLEIFONTEIN, VHEMBE DISTRICT**

Section No	<u>FINAL SUMMARY</u>	Page No	Amount
1	Section 1 - Preliminaries	184	
2	Section 2 - Buildings	276	
3	Section 3 - External Works	312	
4	Section 4 - Electrical Installations	337	
5	Section 5 - Mechanical Works	363	
6	Section 6 - Occupational Health and Safety	369	
	Sub Total 1 - BUILDING COSTS		R
	<u>CONTINGENCY SUM</u>		
	Allow the amount of R 350,000.00 (Three hundred and Fifty thousand rands) for Contingencies to be used as directed by the Principal Agent	Item	350 000. 0
	Sub Total 2 - BUILDINGS (VAT excl.)		R
	Value Added Tax (15%)		R
	Sub Total (VAT INCL.) CARRIED TO TENDER FORM		R
	Carried to Form of Tender		R
	LDPW-B/20151 - BILLS OF QUANTITIES		



PART C5: SCOPE OF WORKS

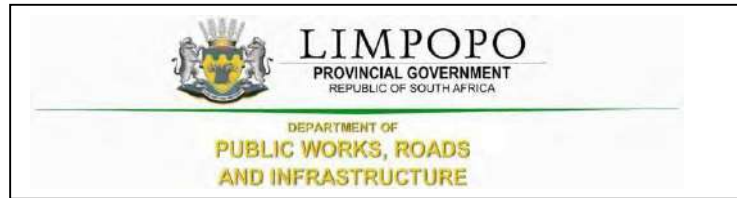

C5.1 SCOPE OF WORKS

Overview of the works

The project comprises the construction of the following:

1. Library Building
2. Guard House
3. Electrical Works
4. Mechanical Works (Air-conditioners & Fire Detection)
5. Borehole
6. Fencing
7. Open paved parking
8. In accordance with the drawings and specifications that will be provided to the contractor.

The Contractor shall provide sufficient qualified technical staff, field staff, and safety personnel to ensure the Works under this contract be satisfactorily carried out safely and meeting the performance targets and programs. The Contractor shall also provide competent attendant(s) to monitor any works in relation to the scope of works.

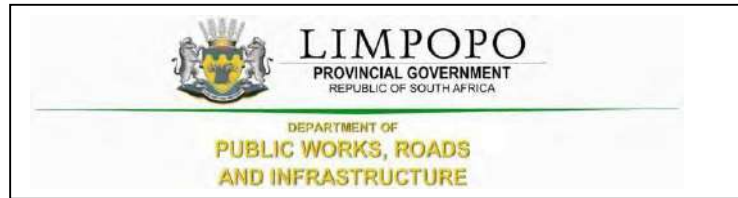

PART C6: EPWP INFRASTRUCTURE GUIDELINE 2015

PART C6: EPWP INFRASTRUCTURE GUIDELINE 2015

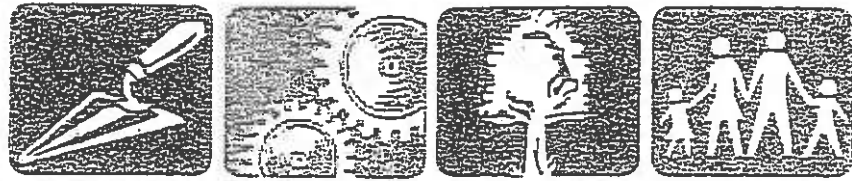

**EXPANDED PUBLIC WORKS PROGRAMME
CONTRIBUTING TO A NATION AT WORK**

**Guidelines for the Implementation
of Labour-Intensive Infrastructure
Projects under the Expanded
Public Works Programme (EPWP)**

SECOND EDITION • JULY 2005



National
Treasury



DFID

Prepared with the assistance of the UK
Department for International Development



public works

Department
Public Works
REPUBLIC OF SOUTH AFRICA

Guidelines for the Implementation of Labour Intensive Projects under the Expanded Public Works Programme (EPWP)

Table of contents

Foreword	i
Terminology	iii
Abbreviations	iii
1. Introduction	1
2. Responsibilities of the public body	2
2.1 Selection of projects	2
2.2 Setting of rate of pay	2
2.3 Appointment of consulting engineers and contractors	3
3 Contract Documentation for Consulting Engineers and Contractors for Labour intensive construction projects	4
3.1 General	4
3.2 Contract Documentation for Consulting Engineering Services	4
3.3 Contract Documentation for the Works	5
3.3.1 Conditions of tender	6
3.3.2 Conditions of contract	6
3.3.3 Scope of work	12
3.3.4 Schedules of quantities	19
4 Design checklist	20
APPENDIX A: SOURCES OF ADDITIONAL INFORMATION	21
APPENDIX B: TYPES OF INFRASTRUCTURE WHICH ARE SUITABLE FOR CONSTRUCTION USING LABOUR INTENSIVE METHODS	23
B.1 Roads	23
B.2 Stormwater	23
B.3 Sewers	24
B.4 Water	24
B.4 Haul of Material	24
B.5 Electricity	24
B.6 Houses, schools and clinics	25
APPENDIX C: REQUIRED SKILLS PROGRAMMES	25
C.1 Client/Employer	25
C.2 Consultants	25
C.3 Contractors	26
APPENDIX D: Definitions of programme indicators	27

Foreword

The Expanded Public Works Programme (EPWP) is one of government's short-to-medium term programmes aimed at alleviating and reducing unemployment. The EPWP will achieve this aim through the provision of work opportunities coupled with training. It is a national programme covering all spheres of government and state-owned enterprises (SOE's). President Mbeki formally announced the programme in his State of the Nation Address in February 2003.

Government's medium-to-long term programmes to address unemployment include increasing economic growth, improving skills levels through education and training, and improving the enabling environment for industry to flourish. The EPWP will continue to exist until these medium-to-long term programmes are successful in reducing unemployment.

The programme involves reorientating line function budgets so that government expenditure results in more work opportunities, particularly for unskilled labour. EPWP projects will therefore be funded through the normal budgetary process, through the budgets of line-function departments, provinces and municipalities.

Opportunities for implementing the EPWP have been identified in the infrastructure, environmental, social and economic sectors. In the infrastructure sector the emphasis is on creating additional work opportunities through the introduction of labour-intensive construction methods. Labour-intensive construction methods involve the use of an appropriate mix of labour and machines, with a preference for labour where technically and economically feasible, without compromising the quality of the product.

All public bodies involved in infrastructure provision are expected to attempt to contribute to the programme. As part of this initiative, the national government has through the 2004 Division of Revenue Act placed some additional conditionalities on the Provincial Infrastructure Grant (PIG) and the Municipal Infrastructure Grant (MIG). These additional conditionalities will require provinces and municipalities to use the "Guidelines for the implementation of labour intensive infrastructure projects under the EPWP" agreed upon between SALGA, National Treasury and the Department of Public Works for identification, design and construction of projects financed through the MIG or PIG. This document contains those guidelines.

International and local experience has shown that, with well-trained supervisory staff and an appropriate employment framework, labour-intensive methods can be used successfully for infrastructure projects involving low-volume roads and sidewalks, stormwater drains, and trenches. On the basis of this experience, and in the context of high levels of unemployment, the national government has decided to require that these infrastructure projects must be carried out labour-intensively.

These guidelines aim to provide provinces and municipalities with the necessary tools to successfully tender these projects as labour-intensive projects. These guidelines have been designed with the aim of minimising the additional work required from provincial and municipal officials. The National Department of Public Works is working with the Construction Education and Training Authority (CETA) to develop the capacity of the construction industry to design and manage labour-intensive infrastructure projects successfully.



The guidelines contain sections which should be copied into the relevant parts of the contract documentation for consulting engineers and contractors. These sections introduce a requirement that certain construction activities must be carried out by hand, under certain conditions. These requirements were formulated on the basis of a thorough review of international and local experience of labour-intensive construction, in order to identify the activities for which it is economically and technically feasible to use labour-intensive methods. The guidelines therefore conform to the Public Finance Management Act requirement for assessing the cost-effectiveness of capital projects. The normal tender evaluation processes are followed under these guidelines, and it is not necessary to apply any special additional preferences for employment creation.

The guidelines include the contents of the Code of Good Practice for Special Public Works Programmes, which has been gazetted by the Department of Labour, and which provides for special conditions of employment for these EPWP projects. In terms of the Code of Good Practice, the workers on these projects are entitled to formal training, which will be provided by training providers appointed (and funded) by the Department of Labour. For projects of up to six months in duration, this training will cover life-skills and information about other education, training, and employment opportunities.

In order to develop the capacity of the construction industry to manage labour-intensive projects, these guidelines also include an eligibility requirement for the appointment of contractors and consulting engineers, i.e. that their key staff involved in the project must undergo special NQF-accredited training programmes in labour-intensive construction.

As an additional means of addressing the capacity in the labour-intensive construction sector, DPW together with the CETA has established a labour intensive contractor learnership programme. The aim of this learnership programme is to produce small contractors qualified to execute work in accordance with these guidelines. The CETA is paying for the classroom training of these contractors.

As part of this learnership programme, learner contractors need to execute projects to gain practical experience. Partnering provinces and municipalities may allocate projects identified and designed using these guidelines to the learner contractors on a negotiated price basis.

An electronic version of these guidelines and electronic copies of the following documents can be obtained on the enclosed CD ROM or downloaded from www.epwp.gov.za:

- Code of Good Practice for Employment and Conditions of Work for Special Public Works Programmes
- Ministerial Determination, Special Public Works Programmes, issued in terms of the Basic Conditions of Employment Act of 1997 by the Minister of Labour in Government Notice N° R63 of 25 January 2002
- Government Gazette (DORA 2004 with MIG and PIG Conditions)
- Documents relating to the Labour Intensive Contractor Learnership Programme



Amendments to the first edition incorporated in this second edition

Minor amendments to the text of the first edition have been made to:

- i) change the deadlines for persons in the employ of the contractor to be accredited in respect of the relevant CETA standards;
- ii) align the text with the requirements of the Construction Industry Development Regulations; and
- iii) delete text that has now become redundant.

Terminology

By hand: refers to the use of tools which are manually operated and powered

Form of contract: refers to a document (conditions of contract) published by industry which establishes the rights, liabilities and obligations of the contracting parties and the procedures for the administration of the contract.

Labour-intensive: refers to methods of construction involving a mix of machines and labour, where labour, utilising hand tools and light plant and equipment, is preferred to the use of heavy machines, where technically and economically feasible.

(Note: The normal emphasis on the cost-effectiveness and quality of the asset must be retained.)

Public body: refers to a department, trading entity, constitutional institution, municipality, public entity or municipal entity

Scope of work: refers to a specification and description of the services or construction works which are to be provided and any other requirements and constraints relating to the manner in which the contract is to be performed

Abbreviations

CETA: Construction Education and Training Authority

CIDB: Construction Industry Development Board

ECOSA: Engineering Council of South Africa

EPWP: Expanded Public Works Programme

FIDIC: French acronym for the International Federation of Consulting Engineers

NEC: New Engineering Contract

NQF: National Qualifications Framework

SANS: South African National Standard

SPWP: Special Public Works Programme



EPWP Contract Data

Payment for the labour-intensive component of the works

Payment for works identified in the Scope of Work as being labour-intensive shall only be made in accordance with the provisions of the Contract if the works are constructed strictly in accordance with the provisions of the Scope of Work. Any non-payment for such works shall not relieve the Contractor in any way from his obligations either in contract or in delict.

Contractor's default in payment to Labourers and Employees

Any dispute between the Contractor and labourers, regarding delayed payment or default in payment of fair wages, if not resolved immediately may compel the Employer to intervene. The Employer may, upon the Contractor defaulting payment, pay the moneys due to the workers not honoured in time, out of any moneys due or which may become due to the Contractor under the Contract.

Minimum Number of Workers to be Employed

The Contractor shall employ a minimum number of unskilled workers, failure to which the Employer may take such steps to source these workers and incorporate them into the Contractor's workforce without any financial adjustment of the Contract. Should the Contractor continually and deliberately fail to adhere to this provision without the express written consent of the Employer, the Employer shall have the right to takeover the project and terminate the Contract in line with the Conditions of Contract.

Employment of National Youth Service Graduates

The Contractor shall employ National Youth Service (NYS) Graduates who have successfully completed the eighteen-month Limpopo Department of Public Works training programme. The Contractor shall select the suitable graduates who have relevant qualifications for the scope of works with the assistance and approval of the Department. The Contractor shall provide the necessary mentorship, tutelage and work experience, to the satisfaction of the Department, for the graduates who shall be required to work closely with experienced Artisans and and/or Tradesmen with a minimum Task Grade of seven (7) in the relevant trade similar to that of the Graduates.

The NYS Graduates shall be remunerated as Task Grade three (3) workers at a minimum and shall receive all relevant allowances including transport and site allowances. He/she shall be free to increase each individual Graduate's wage rate based on their performance. He/she shall enter into Contracts with the Graduates as per the industry norms, standards and relevant legislation. He/she shall take necessary steps to ensure that the engagement of the Graduates does not affect his programme, quality of services or workmanship and the Department will not authorize any sub-standard work or any contract extension attributed to the engagement of these Graduates.

A Provisional Sum shall be included in the Preliminaries of the Schedule of Work or Bill of Quantities for the sole purpose of remunerating the employed Graduates and shall be used for this purpose only. An Item shall also be included for the Contractor's overheads,

charges and profit. In the event that the Provisional Sums stated hereunder are not adequate for the wages and allowances proposed by the Contractor he/she allow for them elsewhere in the Tender. The contractor shall, as far as is reasonably possible, engage NYS Graduates who reside near the project site or at least in the district where the project is being implemented, in order to minimise transport and accommodation expenses. If this is not feasible NYS Graduates from other Limpopo Districts shall be employed with the express permission of the Employer. This condition shall not apply to Graduates who the Contractor intends to add to his staff establishment.

The Table below gives a guide to the minimum number of Graduates to be employed and the relevant Provisional Sums to be allowed for in the Schedule. However, the Contractor shall be at liberty to employ more Graduates than the number stipulated hereunder as long as he/she has allowed for them in other items of the Schedule.

Table 1: NYS Graduates Guideline

Minimum CIDB Class For the Project	Provisional Sum upto 31 March 2010 in Rand*	Minimum Number of Graduates to be Employed
CIDB Class1	Not Applicable	
CIDB Class2		
CIDB Class3	24,000	1
CIDB Class4	48,000	2
CIDB Class5	72,000	3
CIDB Class6	96,000	4
CIDB Class7		
CIDB Class8		

*This Provisional Sum is based on a 6-month contract Period. For Contracts which have a contract period less or greater than six (6) months the Provisional Sums shall be adjusted accordingly.

As a general rule any one individual of the NYS Graduates employed in compliance to this clause shall be allowed to work for an effective period not exceeding twelve (12) months in one or more Departmental contracts except with the express approval of the Department. Should the contractor be willing to employ the individual Graduate for a longer period he shall be at liberty to absorb that graduate into his staff establishment.

Reporting

The Contractor shall submit monthly returns/reports as specified below:

- Signed Muster rolls/pay sheets of temporary workers and permanent staff detailing the number, category, gender, rate of pay and daily attendance. The Reports shall be in EPWP approved Format and shall be subject to the Employer's approval.
- Plant utilization returns.

- Progress report detailing production output compared to the programme of works.

If the Contractor fails to submit any of the Reports, the Employer shall reserve the right to withhold monies due to the Contractor until the relevant approved reports are received.

Provision of Hand tools

The Contractor shall provide his labour force with hand tools of adequate quality, sufficient in numbers and make the necessary provisions to maintain the tools in good and safe working conditions.

Applicable labour laws

The Ministerial Determination, Special Public Works Programmes, issued in terms of the Basic Conditions of Employment Act of 1997 by the Minister of Labour in Government Notice N° R63 of 25 January 2002, as reproduced below, shall apply to works described in the scope of work as being labour intensive and which are undertaken by unskilled or semi-skilled workers.

1 Introduction

- 1.1 This document contains the standard terms and conditions for workers employed in elementary occupations on a Special Public Works Programme (SPWP). These terms and conditions do NOT apply to persons employed in the supervision and management of a SPWP.
- 1.2 In this document –
 - a) "department" means any department of the State, implementing agent or contractor;
 - b) "employer" means any department, implementing agency or contractor that hires
 - c) workers to work in elementary occupations on a SPWP;
 - d) "worker" means any person working in an elementary occupation on a SPWP;
 - e) "elementary occupation" means any occupation involving unskilled or semi-skilled work;
 - f) "management" means any person employed by a department or implementing
 - g) agency to administer or execute an SPWP;
 - h) "task" means a fixed quantity of work;
 - i) "task-based work" means work in which a worker is paid a fixed rate for performing a task;
 - j) "task-rated worker" means a worker paid on the basis of the number of tasks completed;
 - k) "time-rated worker" means a worker paid on the basis of the length of time worked.

2 Terms of Work

- 2.1 Workers on a SPWP are employed on a temporary basis.

- 2.2 Employment on a SPWP does not qualify as employment as a contributor for the purposes of the Unemployment Insurance Act 30 of 1966.

3 Normal Hours of Work

- 3.1 An employer may not set tasks or hours of work that require a worker to work—
- a) more than forty hours in any week
 - b) on more than five days in any week; and
 - c) for more than eight hours on any day.
- 3.2 An employer and worker may agree that a worker will work four days per week.
- 3.3 The worker may then work up to ten hours per day.
- 3.4 A task-rated worker may not work more than a total of 55 hours in any week to complete the tasks allocated (based on a 40-hour week) to that worker.

4 Meal Breaks

- 4.1 A worker may not work for more than five hours without taking a meal break of at least thirty minutes duration.
- 4.2 An employer and worker may agree on longer meal breaks.
- 4.3 A worker may not work during a meal break. However, an employer may require a worker to perform duties during a meal break if those duties cannot be left unattended and cannot be performed by another worker. An employer must take reasonable steps to ensure that a worker is relieved of his or her duties during the meal break.
- 4.4 A worker is not entitled to payment for the period of a meal break. However, a worker who is paid on the basis of time worked must be paid if the worker is required to work or to be available for work during the meal break.

5 Special Conditions for Security Guards

- 5.1 A security guard may work up to 55 hours per week and up to eleven hours per day.
- 5.2 A security guard who works more than ten hours per day must have a meal break of at least one hour or two breaks of at least 30 minutes each.

6 Daily Rest Period

Every worker is entitled to a daily rest period of at least eight consecutive hours. The daily rest period is measured from the time the worker ends work on one day until the time the worker starts work on the next day.

7 Weekly Rest Period

Every worker must have two days off every week. A worker may only work on their day off to perform work which must be done without delay and cannot be performed by workers during their ordinary hours of work ("emergency work").

8 Work on Sundays and Public Holidays

- 8.1 A worker may only work on a Sunday or public holiday to perform emergency or security work.
- 8.2 Work on Sundays is paid at the ordinary rate of pay.
- 8.3 A task-rated worker who works on a public holiday must be paid –
 - a) the worker's daily task rate, if the worker works for less than four hours;
 - b) double the worker's daily task rate, if the worker works for more than four hours.
- 8.4 A time-rated worker who works on a public holiday must be paid –
 - a) the worker's daily rate of pay, if the worker works for less than four hours on the public holiday;
 - b) double the worker's daily rate of pay, if the worker works for more than four hours on the public holiday.

9 Sick Leave

- 9.1 Only workers who work four or more days per week have the right to claim sick-pay in terms of this clause.
- 9.2 A worker who is unable to work on account of illness or injury is entitled to claim one day's paid sick leave for every full month that the worker has worked in terms of a contract.
- 9.3 A worker may accumulate a maximum of twelve days' sick leave in a year.
- 9.4 Accumulated sick-leave may not be transferred from one contract to another contract.
- 9.5 An employer must pay a task-rated worker the worker's daily task rate for a day's sick leave.
- 9.6 An employer must pay a time-rated worker the worker's daily rate of pay for a day's sick leave.
- 9.7 An employer must pay a worker sick pay on the worker's usual payday.
- 9.8 Before paying sick-pay, an employer may require a worker to produce a certificate stating that the worker was unable to work on account of sickness or injury if the worker is –
 - a) absent from work for more than two consecutive days; or
 - b) absent from work on more than two occasions in any eight-week period.
- 9.9 A medical certificate must be issued and signed by a medical practitioner, a qualified nurse or a clinic staff member authorised to issue medical certificates indicating the duration and reason for incapacity.
- 9.10 A worker is not entitled to paid sick-leave for a work-related injury or occupational disease for which the worker can claim compensation under the Compensation for Occupational Injuries and Diseases Act.

10 Maternity Leave

- 10.1 A worker may take up to four consecutive months' unpaid maternity leave.
- 10.2 A worker is not entitled to any payment or employment-related benefits during maternity leave.
- 10.3 A worker must give her employer reasonable notice of when she will start maternity leave and when she will return to work.

Additions to Contract Data

- 10.4 A worker is not required to take the full period of maternity leave. However, a worker may not work for four weeks before the expected date of birth of her child or for six weeks after the birth of her child, unless a medical practitioner, midwife or qualified nurse certifies that she is fit to do so.
- 10.5 A worker may begin maternity leave –
- a) four weeks before the expected date of birth; or
 - b) on an earlier date –
 - (i) if a medical practitioner, midwife or certified nurse certifies that it is necessary for the health of the worker or that of her unborn child; or
 - (ii) if agreed to between employer and worker; or
 - c) on a later date, if a medical practitioner, midwife or certified nurse has certified that the worker is able to continue to work without endangering her health.
- 10.6 A worker who has a miscarriage during the third trimester of pregnancy or bears a stillborn child may take maternity leave for up to six weeks after the miscarriage or stillbirth.
- 10.7 A worker who returns to work after maternity leave, has the right to start a new cycle of twenty-four months employment, unless the SPWP on which she was employed has ended.

11 Family responsibility leave

- 11.1 Workers, who work for at least four days per week, are entitled to three days paid family responsibility leave each year in the following circumstances -
- (a) when the employee's child is born;
 - (b) when the employee's child is sick;
 - (c) in the event of a death of –
 - (i) the employee's spouse or life partner;
 - (ii) the employee's parent, adoptive parent, grandparent, child, adopted child, grandchild or sibling.

12 Statement of Conditions

- 12.1 An employer must give a worker a statement containing the following details at the start of employment –
- (a) the employer's name and address and the name of the SPWP;
 - (b) the tasks or job that the worker is to perform; and
 - (c) the period for which the worker is hired or, if this is not certain, the expected duration of the contract;
 - (d) the worker's rate of pay and how this is to be calculated;
 - (e) the training that the worker will receive during the SPWP.
- 12.2 An employer must ensure that these terms are explained in a suitable language to any employee who is unable to read the statement.
- 12.3 An employer must supply each worker with a copy of these conditions of employment.

13 Keeping Records

- 13.1 Every employer must keep a written record of at least the following –
- (a) the worker's name and position;

- (b) in the case of a task-rated worker, the number of tasks completed by the worker;
 - (c) in the case of a time-rated worker, the time worked by the worker;
 - (d) payments made to each worker.
- 13.2 The employer must keep this record for a period of at least three years after the completion of the SPWP.

14 Payment

- 14.1 An employer must pay all wages at least monthly in cash or by cheque or into a bank account.
- 14.2 A task-rated worker will only be paid for tasks that have been completed.
- 14.3 An employer must pay a task-rated worker within five weeks of the work being completed and the work having been approved by the manager or the contractor having submitted an invoice to the employer.
- 14.4 A time-rated worker will be paid at the end of each month.
- 14.5 Payment must be made in cash, by cheque or by direct deposit into a bank account designated by the worker.
- 14.6 Payment in cash or by cheque must take place –
- (a) at the workplace or at a place agreed to by the worker;
 - (b) during the worker's working hours or within fifteen minutes of the start or finish of work;
 - (c) in a sealed envelope which becomes the property of the worker.
- 14.7 An employer must give a worker the following information in writing –
- (a) the period for which payment is made;
 - (b) the numbers of tasks completed or hours worked;
 - (c) the worker's earnings;
 - (d) any money deducted from the payment;
 - (e) the actual amount paid to the worker.
- 14.8 If the worker is paid in cash or by cheque, this information must be recorded on the envelope and the worker must acknowledge receipt of payment by signing for it
- 14.9 If a worker's employment is terminated, the employer must pay all monies owing to that worker within one month of the termination of employment.

15 Deductions

- 15.1 An employer may not deduct money from a worker's payment unless the deduction is required in terms of a law.
- 15.2 An employer must deduct and pay to the SA Revenue Services any income tax that the worker is required to pay.
- 15.3 An employer who deducts money from a worker's pay for payment to another person must pay the money to that person within the time period and other requirements specified in the agreement law, court order or arbitration award concerned.
- 15.4 An employer may not require or allow a worker to –
- (a) repay any payment except an overpayment previously made by the employer by mistake;
 - (b) state that the worker received a greater amount of money than the employer actually paid to the worker; or

- (c) pay the employer or any other person for having been employed.

16 Health and Safety

- 16.1 Employers must take all reasonable steps to ensure that the working environment is healthy and safe.
- 16.2 A worker must –
 - (a) work in a way that does not endanger his/her health and safety or that of any other person;
 - (b) obey any health and safety instruction;
 - (c) obey all health and safety rules of the SPWP;
 - (d) use any personal protective equipment or clothing issued by the employer;
 - (e) report any accident, near-miss incident or dangerous behaviour by another person to their employer or manager.

17 Compensation for Injuries and Diseases

- 17.1 It is the responsibility of the employers (other than a contractor) to arrange for all persons employed on a SPWP to be covered in terms of the Compensation for Occupational Injuries and Diseases Act, 130 of 1993.
- 17.2 A worker must report any work-related injury or occupational disease to their employer or manager.
- 17.3 The employer must report the accident or disease to the Compensation Commissioner.
- 17.4 An employer must pay a worker who is unable to work because of an injury caused by an accident at work 75% of their earnings for up to three months. The employer will be refunded this amount by the Compensation Commissioner. This does NOT apply to injuries caused by accidents outside the workplace such as road accidents or accidents at home.

18 Termination

- 18.1 The employer may terminate the employment of a worker for good cause after following a fair procedure.
- 18.2 A worker will not receive severance pay on termination.
- 18.3 A worker is not required to give notice to terminate employment. However, a worker who wishes to resign should advise the employer in advance to allow the employer to find a replacement.
- 18.4 A worker who is absent for more than three consecutive days without informing the employer of an intention to return to work will have terminated the contract.
- 18.5 A worker who does not attend required training events, without good reason, will have terminated the contract.

19 Certificate of Service

- 19.1 On termination of employment, a worker is entitled to a certificate stating –
 - (a) the worker's full name;
 - (b) the name and address of the employer;
 - (c) the SPWP on which the worker worked;
 - (d) the work performed by the worker;

Additions to Contract Data

- (e) any training received by the worker as part of the SPWP;
- (f) the period for which the worker worked on the SPWP;
- (g) any other information agreed on by the employer and worker.

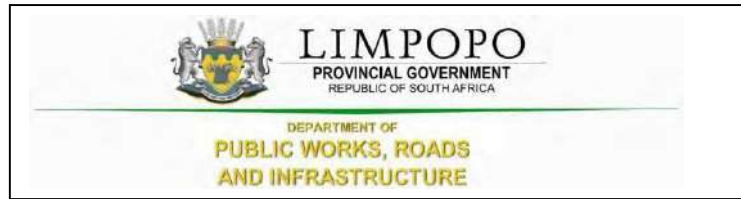

PART C7: SITE INFORMATION AND DRAWINGS

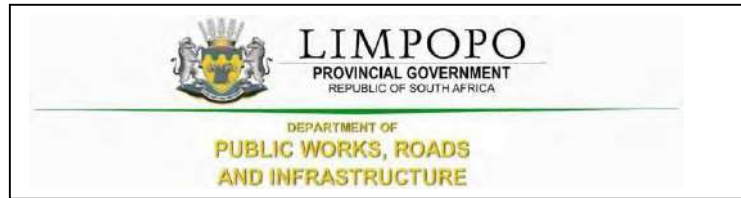

PART C7.1: SITE INFORMATION

DEVELOPMENT OF INFRASTRUCTURE PROJECTS: NEW LIBRARIES FOR THE LIMPOPO DEPARTMENT OF SPORTS, ART AND CULTURE (DSAC) AT THE FOLLOWING LOCATIONS: VLEIFONTEIN, TSHAULU, SEKHUKHUNE DISTRICT AND BOTSHABELO

Stage 4 Vleifontein Site Information

2021/10/18

Limpopo Department of Public Works, Roads & Infrastructure

Prepared by LEMEG Architects

Contents

VLEIFONTEIN	2
Location.....	2
Identification.....	2
Soil Condition	2
Flora	2
Access.....	2
Services	2
Title Deeds	3

VLEIFONTEIN

LOCATION

The proposed site for the Vleifontein Community Library is located in Vleifontein Area and within Ha-Tshikota-A Township, about 21km south-east of Louis Trichardt, within the Vhembe District of the Limpopo Province. The proposed Library site is accessible from the Provincial Road D2677, which is a gravel road, however the surfaced street running through Ha-Tshikota-A Township will be used for the main access to the library site. The geographical coordinates of the proposed site are: 23°13'15.20"S, 29°59'20.60"E (SMEC Inception Report).

IDENTIFICATION

The corner pegs have been identified by a professional land surveyor.

SOIL CONDITION

A geotechnical report has been prepared by the appointed Geotechnical consultant (DIGES GROUP: Final Near Surface Geotechnical Investigation Report For New Library For The Limpopo Department Of Arts And Culture In Vleifontein, Vhembe District - Limpopo Province).

The site is underlain by gneiss of the Goudplaats Gneiss basement as stated in the Geotechnical report. Observation made on site suggest that the residual gneiss has recently been blanketed by transported soils. The residual gneiss was distinguished by a pebble marker which was immediately below the transported soils (DIGES Geotechnical Report).

FLORA

The site is a greenfield site without any boundary fence. There is no evident significant vegetation growing on the site.

ACCESS

The library site is easily accessible from the Provincial Road D2677 or the municipal surfaced road, passing the library site. A short 25m long paved access road is planned from the municipal road into the library site (SMEC: Design Report - Vleifontein).

SERVICES

It is a greenfield site, no services available for the new library. The Proposed Scope of Work for the Civil Services are the following:

- Earthworks for the building platforms (Levels, compaction and material specifications).
- Parking areas (Layer works, levels & details).
- Access from main road to the library (Layer works, levels & details).
- Walkways (Layer works, levels & details).
- Storm water channels, pipes and berms.

- Water storage for domestic and fire purposes.
- Pipe work and connections for the pumps for fire water.
- Connection to water supply (Municipal and boreholes).
- Water reticulation network in the project boundary.
- Sewer reticulation with a sewer septic tank.
- Security fence and access gates.

TITLE DEEDS

A Proof of Permission to Occupy the site has been provided by the Department.

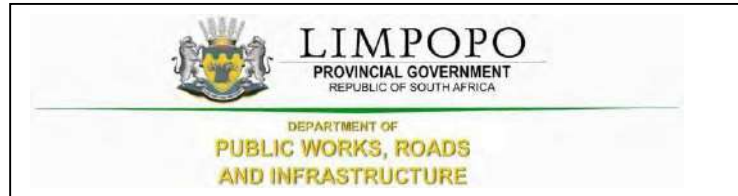

PART C7.2: DRAWINGS

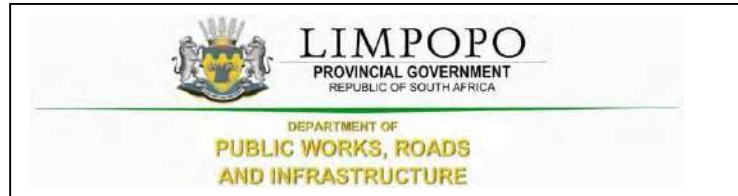

PART C7.2.1: ARCHITECTS SPECIFICATIONS AND DRAWINGS

2101

PROJECT NAME

DPW LIBRARIES

DOCUMENT NAME

SPECIFICATIONS

BUILDING NAME

NEW LIBRARIES

PROJECT LEADER

ABIGAIL BARNARD

SPECIFICATION AUTHOR

HLABIRWA CHUENE

DATE

Tuesday, 24 August 2021

REVISION

1

A4

WWW.LEMEG.COM

LEMEG
ARCHITECTS

GAUTENG

Unit 1b | 2 Victoria Link | R21 Business Park | Irene | 012 492 7797

LIMPOPO

45 Bendor Drive | Hampton Court | Polokwane | 015 296 4351

LEMEG ARCHITECTS CC | CK 1988/12840/23 | SAIA PRACTICE

Copyright is vested in the practice in terms of the act (act 98 of 1978)

TABLE OF CONTENTS

TITLE

C30	Site clearance, excavation and filling
F10	In situ concrete mixes/ casting/ curing
F20	Formwork
F30	Steel reinforcement
F40	Designated joints in in situ concrete
F41	Worked and applied finishes to in situ concrete
G11	Precast/ Composite concrete floors/ roof decks
H10	Brick/ Block walling
H40	Accessories/ Sundry items for brick / block/ stone walling
H41	Precast sills/ copings/ features
J11	Cementitious mortar tanking/ damp proofing
J30	Liquid applied tanking/ damp proofing
J40	Flexible sheet tanking/ damp proofing
J41	Reinforced bitumen membrane waterproof coverings
K31	Metal profiled sheet cladding/ covering
L10	Carpentry/ Timber framing/ First fixing
L21	Timber/ uPVC doors/ shutters/ hatches
L60	General fixtures and fittings
L70	Unframed isolated trims/ skirtings/ sundry items
M10	Plasterboard dry linings/ partitions
M11	Plasterboard ceilings
M22	Panel cubicles
M30	Demountable suspended ceilings
N20	Rubber/ Cork/ Plastics/ Linoleum/ Carpet tiling/ sheeting
O10	General signage systems
O12	Fire and safety signage systems
O20	Door/ Window Ironmongery
P10	Structural steel framing
Q11	Curtain walling
Q20	Metal windows/ louvres/ screens/ rooflights
Q21	Metal doors/ shutters/ hatches
Q22	Stairs/ Walkways/ Handrails/ Balustrades
R10	Cement based levelling/ wearing screeds
R20	Plastered/ Rendered/ Roughcast coatings

S10	Stone/ Concrete/ Quarry/ Ceramic/ Mosaic tiling
T10	Rainwater drainage systems
T11	Foul drainage above ground
T12	Drainage below ground
T60	Sanitary appliances/ fittings
T90	Hot and cold water supply systems - domestic
U90	Electrical installation - domestic
W10	General glazing and mirrors
X10	Painting/ Clear finishing

DEFINITIONS

MANUFACTURERS' INSTRUCTIONS

means the manufacturer's instructions at the time of tender.

APPROVAL

means approval by the architect in writing, and is limited to visual appearance of the work, material or components. Approval does not relieve the contractor from compliance with the specification.

DRAWING(S)

means the drawing(s) forming part of the contract documents, and any modification thereof or additions thereto delivered by the architect/principal agent to the contractor during the execution of the works.

MOD AASHTO

refers to an internationally accepted test to determine the density of compacted material like soil filling, expressed as a percentage of the maximum compaction of the filling at various moisture contents as determined in a laboratory.

SANS

means the South African National Standards.

SABS-CKS

refers to specifications prepared by the SABS, mainly for the procurement of products for the use of government departments.

SABS EN

means a European Norm adopted by the SABS as a National Standard. (ENV is a voluntary norm)

SPECIFIED

means as specified in a Particular Specification, on drawings, in the bill of quantities or in any other contract document.

UNITS OF MEASUREMENTS

The units of measurement are metric units as standardised by the "Système International d'Unités" (SI). The following unit symbols are used in this document:

° C - Degrees Celsius

g - Gram

Hz - Hertz

H - Hour

kN - Kilonewton

kPa - Kilopascal

KW - Kilowatt

L - Litre

M - Metre

m² - Square Metre

m3 - Cubic Metre

mm - Millimetre

MPa - Megapascal

T - Tonne

NOTES

ORGANIZATION OF THIS DOCUMENT

In order to improve cross-reference to the bill of quantities, this document has been organised largely in accordance with the Standard System of Measuring Building Work, issued by the Association of South African Quantity Surveyors.

DESCRIPTION OF ITEMS

The description of an item implies the complete supply, assembly and operation of the item unless otherwise specified.

TRADE NAMES

Materials, components or products in this Document are not specified by trade name but by reference to standards. Reference to a standard rather than to a specific product or trade name levels the field when tendering, ensures a minimum level of quality, and ensures adherence to safety and health standards. Because the standard does not refer to trade names, any supplier can manufacture to a specified standard. These standards have authority in that they are drawn up by a committee consisting of some of the major players in the manufacturing of a specific material, component or product. The standards of the South African National Standards (SANS) are the main source of reference. After tenders have been evaluated and a contract concluded, the successful tenderer may apply to the architect/principal agent for the use of materials, products or components that do not comply to these standards. In these cases the architect/principal agent shall expect any one or all of the following:

- A sample for inspection
- Proof of quality
- Test reports
- Capability reports on the factory
- A saving in cost.

Applications for the use of other materials, products or components must be approved in writing by the architect/principal agent before any such materials, components or products are ordered.

Where Trade Names are specified in this Document, such specification shall be as a result of the specialist nature of the material or component.

COMPLIANCE WITH STANDARDS

When so requested by the architect/principal agent, provide evidence in the form of delivery slips, certificates or other written proof that material or components comply with the standards as laid down in this specification. Products that are specified as mark-bearing must bear the mark of the relevant standards body.

STANDARDS, LATEST EDITION

Standards referred to in this specification are the latest edition, including all amendments, published three calendar months or longer before the closing date of tenders.

ACCURACY OF BUILDING WORK

Building work must comply with SANS 10155:2009, accuracy level 2, except where specified otherwise.

C	DEMOLITION AND GROUNDWORK
----------	----------------------------------

C30	SITE CLEARANCE, EXCAVATION AND FILLING	C
C30/310 SOIL POISONING	<i>Applied to foundation trenches and filling under surface beds in accordance with SABS 1164 / 1165 by specialist, including certificate of registration of the pest control operator as issued by the Department of Agriculture A certificate of guarantee (10 years) to be issued by applicator.</i>	
C40/320 EXCAVATIONS	<i>Excavations for columns bases and foundations: Excavate below ground level, compact bottom of trenches to 95% Mod AASHTO before casting foundations. See Engineer's drawings</i>	
C50/330 FILLING	<i>Earth filling in layers not exceeding 150 mm compacted to 95% Mod AASHTO. The excavations to the back of the retaining walls to be carefully filled with coarse aggregate before compacting. See Engineer's drawings</i>	

F	IN-SITU CONCRETE
----------	-------------------------

F10	IN SITU CONCRETE MIXES/ CASTING/ CURING	F
F10/212 DESIGN OF STRUCTURAL CONCRETE	<i>Materials, drawings, specification, protective equipment and quality assurance must be according to the engineer</i>	F10
F20	FORMWORK	F
F20/624	PLAIN SMOOTH FINISH	F20
F20/626	FINE SMOOTH FINISH	F20
F30	STEEL REINFORCEMENT	F
F40	DESIGNATED JOINTS IN IN SITU CONCRETE	F
F41	WORKED AND APPLIED FINISHES TO IN SITU CONCRETE	F
F41/630	SMOOTH FLOATED FINISH	F41
F41/632	TROWELLED FINISH	F41
F41/634	<i>TROWELLED FINISH FOR WEARING SURFACES</i>	F41

G	PRECAST CONCRETE
----------	-------------------------

G11	PRECAST/ COMPOSITE CONCRETE FLOORS/ ROOF DECKS	G
H10/310 PRECAST CONCRETE LINTELS	<i>Concor (or similar approved) pre-stressed fabricated concrete lintels: 110x75mm lintels above all door frames and openings. Projection to be a minimum of 230mm on either side of the opening to ensure sufficient bonding.</i>	G11

H	MASONRY
----------	----------------

H10	BRICK/ BLOCK WALLING	H
------------	-----------------------------	----------

H10/310 CLAY FACING BRICKWORK ABOVE DPC	<p><i>Standard: SANS 227.</i></p> <ul style="list-style-type: none"> - <i>Classification: [FBX].</i> - <i>Exposure zone: [Zone 1-2].</i> - <i>Efflorescence: [Normal grade].</i> <p><i>Manufacturer: [Corobrik® or similar approved].</i></p> <ul style="list-style-type: none"> - <i>Product reference: [Country Classic].</i> - <i>Work sizes (length x width x height): [222 x 106 x 73 mm].</i> - <i>Special shapes: [As shown on drawings].</i> - <i>Foundation and loadbearing brickwork: NFXE clay bricks (20MPa nominal compressive strength) in class 2 mortar – in stretcher bond.</i> 	H10
H10/320 CLAY FACING BRICKWORK ABOVE DPC	<p><i>Standard: SANS 227.</i></p> <ul style="list-style-type: none"> - <i>Classification: [FBX].</i> - <i>Exposure zone: [Zone 1-2].</i> - <i>Efflorescence: [Normal grade].</i> <p><i>Manufacturer: [Corobrik® or similar approved].</i></p> <ul style="list-style-type: none"> - <i>Product reference: [Onyx].</i> - <i>Work sizes (length x width x height): [222 x 106 x 73 mm].</i> - <i>Special shapes: [As shown on drawings].</i> - <i>Foundation and loadbearing brickwork: NFXE clay bricks (20MPa nominal compressive strength) in class 2 mortar – in soldier bond.</i> 	H10
H10/340 CLAY	<i>Standard: SANS 227.</i>	H10
COMMON BRICKWORK IN PARTY WALLS	<p><i>Classification: [NFP].</i></p> <p><i>Manufacturer: [Corobrik® or similar approved].</i></p> <ul style="list-style-type: none"> - <i>Product reference: [non-loadbearing Imperial plaster brick].</i> - <i>Average compressive strength (minimum): [7 MPa].</i> - <i>Work sizes (length x height x thickness): [222 x 106 x 73 mm].</i> - <i>Water absorption to SANS 227: [Between 7% and 12%].</i> - <i>Moisture expansion limit: [Category II].</i> - <i>Configuration: [Solid]</i> 	
H40	ACCESSORIES/ SUNDRY ITEMS FOR BRICK / BLOCK/ STONE WALLING	H
H40/360 DAMP PROOF COURSE - POLYOLEFIN	<p><i>Gundle® API (or similar approved) Black SABS 375 µm embossed plastic in solid walls conforming to SANS 952-1:2011 Installed in strict accordance with manufacturer's specification.</i></p>	H40
H40/374A FIBRE CEMENT SILLS LAID IN CEMENT GAUGED MORTAR	<p><i>Everite Nutec window internal sill, size 1022 x 150mm x 15mm thick (Code: 031-508), manufactured in accordance with SANS 803:2005 and installed level with window sill lug screwed to underside of sill at 400mm centres, minimum of 75mm from end of window sill and bedded in Class II mortar with plastic slip joints at end of sills at plaster reveals and projecting from the finished face of wall, all in accordance with the manufacturer's recommendations.</i></p>	H40
H40/376 PRESTRESSED CONCRETE LINTELS	<p><i>Concor (or similar approved) pre-stressed fabricated concrete lintels: 110x75mm lintels above all door frames and openings. Projection to be a minimum of 230mm on either side of the opening to ensure sufficient bonding.</i></p>	H40
H40/380 COPING UNITS	<i>Brick on edge coping</i>	H40
H40/670 HORIZONTAL DPCS	<p><i>Gundle® API (or similar approved) Black SABS 375 µm embossed plastic in solid walls conforming to SANS 952-1:2011 Installed in strict accordance with manufacturer's specification.</i></p>	H40
H40/680 STEPPED DPCS IN EXTERNAL WALLS	<p><i>Gundle® API (or similar approved) Black SABS 375 µm embossed plastic in solid walls conforming to SANS 952-1:2011 Installed in strict accordance with manufacturer's specification.</i></p>	H40

H40/685 SILL DPCS *Gundle® API (or similar approved) Black SABS 375 µm embossed plastic in solid walls conforming to SANS 952-1:2011 Installed in strict accordance with manufacturer's specification.* H40

H40/690 COPING/ CAPPING DPCS	Gundle® API (or similar approved) Brickgrip DPC 250µm damp proof course in solid walls conforming to SANS 952-1:2011 Installed in strict accordance with manufacturer's specification.	H40
---------------------------------	--	-----

J	WATERPROOFING	
----------	----------------------	--

J41	REINFORCED BITUMEN MEMBRANE WATERPROOF COVERINGS	J
J41/110 DAMP PROOF MEMBRANE	Gundle® API (or similar approved) Green SABS 250µm damp proof membrane under surface beds conforming to SANS 952-1:2011 Installed in strict accordance with manufacturer's specification.	J41
J41/120 DAMP PROOF COURSE	Gundle® API (or similar approved) Black SABS 375 µm embossed plastic in walls and under cills. Installed in strict accordance with manufacturer's specification.	J41

K	CLADDING AND COVERING	
----------	------------------------------	--

K31	METAL PROFILED SHEET CLADDING/ COVERING	K
K31/310 METAL COVERING TO ALL ROOFS	Global Roofing Solutions (or similar approved) 0.58mm thick 700mm cover Klip-Tite™ profile Chromadek® Z200 spelter ISQ550 Dark Dolphin finish top coat and Pebble Grey backing coat Galvanised steel roof sheeting, fixed to steel intermediate purlins at MAX 2500mm centres and eaves and ridge purlins at MAX 2100mm centres using KL700 plus clips fixed with 10No.16 x 16mm long self-drilling wafer head PH2 screws, No. 3 drill point fasteners, all in accordance with the manufacturer's specifications. <ul style="list-style-type: none"> • Brand: ArcelorMittal • Climatic Condition: inland - C1/C2 Low Corrosion Risk. 	K31
K31/345 GUTTERS BOUNDARY WALL	Profile Colorbond pre-coated Chromadek seamless gutter, size 150 x 125 x 0,5mm thick in colour Armour Grey including matching rivet-fixed mitres and end caps internally sealed using Silicon Mastic, hung by nail fixed internal aluminium hangers at 800mm centres with rectangular fluted downpipes, size 100mm Dia x 0,5mm thick in colour Armour Grey fixed to walls with pre-painted downpipe cleats using nail-in anchor fixings.	K31
K31/380A THERMAL INSULATION	Install Isover 135mm thick Aerolite non-combustible light weight Glasswool thermal ceiling insulation. <ul style="list-style-type: none"> • R-value: 3.38m² K/W • Thermal conductivity: 0.04 W/m²/K. 	K31
K31/400A PROFILE FILLERS GENERALLY	Sondor Performance Foams eaves and ridge fillers	K31
K31/640A FLASHINGS/ TRIMS	Global Roofing Solutions (or similar approved) 0.80mm thick Chromadek® Z200 spelter ISQ550 Charcoal Grey finish top coat and Pebble Grey backing coat Galvanised steel, girth 231mm drip flash (Code: FK76), fixed in accordance with manufacturer's specifications. <ul style="list-style-type: none"> • Brand: ArcelorMittal • Climatic Condition: inland - C1/C2 Low Corrosion Risk. 	K31
K31/640B FLASHINGS/ TRIMS	Global Roofing Solutions (or similar approved) 0.80mm thick Chromadek® Z200 spelter ISQ550 Charcoal Grey finish top coat and Pebble Grey backing coat Galvanised steel, girth 185mm counter flash (Code: FK77), fixed in accordance with manufacturer's specifications. <ul style="list-style-type: none"> • Brand: ArcelorMittal • Climatic Condition: inland - C1/C2 Low Corrosion Risk. 	K31
K31/640C FLASHINGS/ TRIMS	Global Roofing Solutions (or similar approved) 0.80mm thick Chromadek® Z200 spelter ISQ550 Charcoal Grey finish top coat and Pebble Grey backing coat Galvanised steel, girth 375mm headwall flash (Code: FK78), fixed in accordance with manufacturer's specifications. <ul style="list-style-type: none"> • Brand: ArcelorMittal • Climatic Condition: inland - C1/C2 Low Corrosion Risk. 	K31
K31/640D FLASHINGS/ TRIMS	Global Roofing Solutions (or similar approved) 0.80mm thick Chromadek® Z200 spelter ISQ550 Charcoal Grey finish top coat and Pebble Grey backing coat Galvanised steel, girth 408mm sidewall flash (Code: FK79), fixed in accordance with manufacturer's specifications. <ul style="list-style-type: none"> • Brand: ArcelorMittal • Climatic Condition: inland - C1/C2 Low Corrosion Risk. 	K31
K31/640E FLASHINGS/ TRIMS	Global Roofing Solutions (or similar approved) 0.80mm thick Galvanised steel Z200 spelter ISQ550 Chromadek® Dark Dolphin finish top coat and Pebble Grey backing coat Galvanised steel, girth 550mm ridge cap (Code: FK73), fixed in accordance with manufacturer's specifications. <ul style="list-style-type: none"> • Brand: ArcelorMittal • Climatic Condition: inland - C1/C2 Low Corrosion Risk 	K31

K31/640F FLASHINGS/ TRIMS	<p><i>Global Roofing Solutions (or similar approved) 0.80mm thick Galvanised steel Z200 spelter ISQ550 Chromadek® Charcoal Grey finish top coat and Pebble Grey backing coat Galvanised steel, girth 580mm barge (Code: FK713) fixed in accordance with manufacturer's specifications.</i></p> <ul style="list-style-type: none"> • Brand: ArcelorMittal • Climatic Condition: inland - C1/C2 Low Corrosion Risk 	K31
------------------------------	--	-----

L	CARPENTRY AND JOINERY
----------	------------------------------

L10	CARPENTRY/ TIMBER FRAMING/ FIRST FIXING	L
L10/310 STRUCTURAL	<i>All solid softwood structural timber must be stress-graded sawn softwood structural timber to comply with</i>	L10

L10/310 STRUCTURAL	Finger-jointing for joining end-to-end lengths is allowed.	L10
L10/310 STRUCTURAL SOFTWOOD (GRADED DIRECT TO STRENGTH CLASS) FOR STRUCTURAL USE GENERALLY	<i>All structural laminated timber must comply with SABS 1460, of hardwood or softwood, exposure class, type, appearance and finish, adhesive type and exposure class, stress grade, and preservative treatment as specified.</i>	L10

L10/120 PREFABRICATED TIMBER ROOF TRUSS	114 x 50mm thick pre-fabricated SA Pine roof trusses as indicated at max 1200mm centres complete with cross bracing supply ENG certificate	L10
---	--	-----

L10/410 FASCIAS/ BARGES/ SOFFITS	<p><i>Global Roofing Solutions (or similar approved) 0.80mm thick Galvanised steel Z200 spelter ISQ550 Chromadek® Charcoal Grey finish top coat and Pebble Grey backing coat Galvanised steel, girth 580mm barge (Code: FK713) fixed in accordance with manufacturer's specifications.</i></p> <ul style="list-style-type: none"> • Brand: ArcelorMittal • Climatic Condition: inland - C1/C2 Low Corrosion Risk 	
-------------------------------------	--	--

L21	TIMBER/ UPVC DOORS/ SHUTTERS/ HATCHES	L
------------	--	----------

L60	GENERAL FIXTURES AND FITTINGS	L
------------	--------------------------------------	----------

L60/324SHELVING SYSTEM GENERAL OFFICES	Screw and plug metal shelf bands to walls. Bolt the top hole of each band with a 6 mm diameter expansion bolt or frame fixing anchor. Start first band 100 mm away from corners of rooms or from other shelves which are at right angles.	L60
--	---	-----

L60/380 L60/432 ENTRANCE MATTING	FITTED KITCHEN UNITS <i>mat-lok Aluguard with recess frame AMF31/31. Install mat-lok Aluguard 10mm gauge, closed construction, heel-proof barrier mat, consisting of natural grey (colour) electrostatic, buffed-nylon tyre-rubber strips, inserted and fixed into modular aluminium scraper sections, together with recess frame AMF31/31 to be screeded in by contractor as supplied by manufacturer.</i>	L60 L60
--	---	------------

L70	UNFRAMED ISOLATED TRIMS/ SKIRTINGS/ SUNDRY ITEMS	L
------------	---	----------

L70/350 PINBOARDS	Best Board Manufacturing Cc (or similar approved) carpeted pin board, 1200x1500mm in charcola carpet complete with delux anodised aluminium frame, rounded plastic corners and mounted horizontally against the masonry wall with mounting brackets, all in accordance with manufacturer's recommendations.	L70
-------------------	---	-----

L70/380	BRACKET SUPPORTS FOR SHELVES	L70
---------	------------------------------	-----

M	CEILINGS/ PARTITIONS/ ACCESS FLOORING
----------	--

M10	PLASTERBOARD DRY LININGS/ PARTITIONS	M
------------	---	----------

M11	PLASTERBOARD CEILINGS	M
------------	------------------------------	----------

M11/110 SUSPENDED GYPSUM PLASTERBOARD CEILING	<p>1 layer Gyproc RhinoBoard 9.5mm is fixed to Donn Steel Branderling installed at maximum 400mm centres. Fix Gyproc RhinoBoard using Gyproc RhinoBoard Sharp Point Screws 25mm at maximum 150mm centres. All joints shall be staggered. Apply Gyproc RhinoTape to all joints and skim the ceiling using Gyproc RhinoLite/Gyproc Cretestone. Ceiling grid consisting of Donn Suspension Brackets fixed to tie beam/joist using one line of 2 Gyproc RhinoBoard Sharp Point Screws 32mm. Install Donn Galvanised Steel Angle 25mm x 25mm at ceiling level to the wall running perpendicular to the direction of steel branderling. Install Donn Steel Branderling onto the suspension brackets. Fix steel branderling to the galvanised steel angle using Donn Wafer Head Tek Screws 13mm. Donn SM25 recessed wall angle perimeter trim fixed to wall using fixings at 300mm centre.</p> <ul style="list-style-type: none"> • Ceiling System: Gyproc Skimmed Ceiling System 9.5mm/SB • Ceiling Grid: concealed ceiling grid. 	M11
M11/130 ACOUSTIC CEILINGS	<p>OWAcoustic Constellation Premium biologically absorbable mineral wool ceiling tiles, NRC - 0.70, CAC - 33dB, Fire classification A2-s1, d0, weight - 4.5 kg/m², size 1200 x 600 x 15mm with Square-edge and white painted finish, laid on fire rated OWAconstruct S15 exposed demountable T15 suspension system, comprising galvanised main tees and cross tees with main tees suspended by means of galvanised hangers at centres not exceeding 1200mm, and all installed to manufacturer's instructions.</p> <p>OWAconstruct Shadowline W-trim, plugged and screwed at centres not exceeding 200mm.</p>	M11
M11/362 ACCESS PANELS TO FLUSH PLATERED CEILINGS IN POSITIONS INDICATED ON DRAWINGS	<p>Extra over ceiling for Pelican Bottom Hung Access Panel comprising matt white powder coated aluminium T-Frame 600 x 1200mm, fitted flush to ceiling with and including screw fixing through frame into JUMBO® Grid / Branderling. All installations to be done in accordance with manufacturer's recommendations.</p>	M11
M22	PANEL CUBICLES	M
M30	DEMOUNTABLE SUSPENDED CEILINGS	M
M30/310 SUSPENDED CEILING SYSTEM	<p>Lay Gyproc Gyprex Fissured 1200mm x 600mm ceiling tile into the Donn ceiling grid. Ceiling grid consisting of Donn Wall Angle (SM25/M6) fixed to the perimeter wall using fixings at 300mm centres. Space Donn Main Tees T38 FR at 1200mm centres. Suspend main tees using Donn Pre-stretched Galvanised Hanger wire 2.5mm thick or Donn hanger strap 19mm at 1200mm centres. Donn Pre-stretched Galvanised Hanger wire shall be put through the main tees hole and would wind 3 times around itself. 2 steel pop-rivets or one Donn Wafer Head Tek screw 13mm shall be used to fix the hanger strap to the main tees web. Install Donn Cross Tees T38V/T32V (1200 long) at 600mm centres to create a 1200mm x 600mm ceiling grid. Main tee should be fixed to the wall using angle cleats.</p> <ul style="list-style-type: none"> • Ceiling System: Gyproc Exposed Ceiling System Gyprex Fissured 1200 x 600mm 	M30
M30/360 PERIMETER TRIMS AROUND ALL SUSPENDED CEILING SPACES	<p>Donn SM25 recessed wall angle perimeter trim fixed to wall using fixings at 300mm centre.</p>	M30
M30/650 EXPOSED GRIDS	<p>Space Donn Main Tees T38 FR at 1200mm centres. Suspend main tees using Donn Pre-stretched Galvanised Hanger wire 2.5mm thick or Donn hanger strap 19mm at 1200mm centres. Donn Pre-stretched Galvanised Hanger wire shall be put through the main tees hole and would wind 3 times around itself. 2 steel pop-rivets or one Donn Wafer Head Tek screw 13mm shall be used to fix the hanger strap to the main tees web. Install Donn Cross Tees T38V/T32V (1200 long) at 600mm centres to create a 1200mm x 600mm ceiling grid. Main tee should be fixed to the wall using angle cleats.</p>	M30
M30/695 CEILING MOUNTED LUMINAIRES	<p>By Electrical Engineer</p>	M30
M30/700 TRUNKING	<p>By Electrical Engineer</p>	M30

M30/705 MECHANICAL *By Mechanical Engineer*
SERVICES

M30

N FLOOR COVERINGS		
N20	RUBBER/ CORK/ PLASTICS/ LINOLEUM/ CARPET TILING/ SHEETING	N
N20/330A	CARPET TILING	N20
N20/400A	PROPRIETARY STAIR NOSINGS	N20
N20/410A	PROPRIETARY EDGINGS/ COVER STRIPS/ TRANSITION STRIPS	N20
N20/704	LOOSE LAID CARPET TILES	N20
O IRONMONGERY AND SIGNAGE		
O10	GENERAL SIGNAGE SYSTEMS	O
O10/110 SIGNAGE SYSTEM FOR DIRECTORY	<i>Custom design to detail drawings</i>	O10
O10/130 EXTERNAL SIGNAGE SYSTEM FOR COMPANY LOGO	<i>Tenant installation</i>	O10
O10/140 ROAD SIGNAGE SYSTEM - NON-RETROREFLECTIVE	<i>By Civil Engineer</i>	O10
O10/410.POSTS FOR EXTERNAL SIGNS	<i>By Civil Engineer</i>	O10
O10/640.FOUNDATION S FOR EXTERNAL POSTS	<i>By Civil Engineer</i>	O10
O10/660.EXPOSED CONCRETE FOUNDATIONS TO POSTS	<i>By Civil Engineer</i>	O10
O12	FIRE AND SAFETY SIGNAGE SYSTEMS	O
	<i>Symbolic safety signs on aluminium alloy backing sheets must comply with SABS 1186, to size as specified. Screw plates and signs to walls, doors etc. in an approved manner, or as specified.</i>	
O12/110 FIRE SIGNAGE SYSTEMS FOR EQUIPMENT & SAFETY	<i>By Fire Engineer</i>	O12
O12/120 SAFETY SIGNAGE SYSTEMS - MANDATORY ACTION	<i>By Fire Engineer</i>	O12
O12/400 PHOTOLUMINESCENT SIGNS	<i>By Fire Engineer</i>	O12
O20	DOOR/ WINDOW IRONMONGERY	O
O20/312	IRONMONGERY FROM SINGLE PROPRIETARY RANGE <i>Detailed ironmongery by Dormakaba (or similar approved)</i>	O20 O20
O20/350	OVERHEAD DOOR CLOSERS DOORS AS INDICATED ON SCHEDULES <i>Detailed ironmongery by Dormakaba (or similar approved)</i>	O20 O20
O20/352	FLOOR SPRINGS DOORS AS INDICATED ON SHCEDULES <i>Detailed ironmongery by Dormakaba (or similar approved)</i>	O20 O20

O20/354	ELECTROMAGNETIC HOLD OPEN/ SWING-FREE DEVICES (24 V) FIRE ESCAPE DOORS <i>Detailed ironmongery by Dormakaba (or similar approved)</i>	O20 O20
O20/372	PANIC EXIT DEVICES TO FIRE ESCAPE DOORS <i>Detailed ironmongery by Dormakaba (or similar approved)</i>	O20 O20
O20/374	DOOR BOLTS TO TIMBER DOUBLE DOORS <i>Detailed ironmongery by Dormakaba (or similar approved)</i>	O20 O20

P	STEELWORK	
----------	------------------	--

P10	STRUCTURAL STEEL FRAMING	P
P10/110 HOT ROLLED STEEL FRAMING SYSTEM	<i>Materials, drawings, specification, protective equipment and quality assurance must be according to the engineer</i>	P10
P10/120 PREFABRICATED LIGHT GAUGE STEEL ROOF TRUSSES TO ROOF SECTIONS	<i>Materials, drawings, specification, protective equipment and quality assurance must be according to the manufacturer</i>	P10
P10/630 COLUMN BASES	<i>Materials, drawings, specification, protective equipment and quality assurance must be according to the engineer</i>	P10

Q	METALWORK	
----------	------------------	--

Q11	CURTAIN WALLING	Q
	<i>Aluminium framed windows and doors must be manufactured according to the minimum requirements of the Association of Architectural Aluminium Manufacturers of South Africa (AAAMSA). Each window and door must be marked with the mark and number of the test certificate issued by AAAMSA, or a copy of the latest performance test certificate for similar products must be provided. The supplier is responsible for confirmation of opening sizes. Frame parts must be joined by mechanical means or by welding. Joints may have flush, stepped or lapped surfaces. Mitred joints may only be flush. All joints must be sealed. Contact between incompatible materials is not allowed. Accessories must be removable without having to remove the frames from the structure. Sliding members must be fitted so that no metal to metal sliding contact occurs. Sealants must be compatible with aluminium and fitted so that the performance of the sliding or swinging parts is not impaired by their deterioration. Glazing beads, gaskets and glazing compounds must be compatible with the aluminium, its finish and with the glass. No putty is permitted. Hardware and fittings must be resistant to atmospheric corrosion and be accessible for adjustment, repair and replacement after the window or door has been installed. Fastenings must be compatible with aluminium and its finishes.</i>	
Q11/320A STORE FRONT WALLING TO ALL SHOPS	<i>As per Aluminium schedules</i>	Q11
Q11/325 ALUMINIUM SHOPFRONT	<i>As per Aluminium schedules</i>	Q11
Q11/346 HINGED/ PIVOT DOORS	<i>As per Aluminium schedules</i>	Q11
Q11/360 ALUMINIUM ALLOY FRAMING SECTIONS	<i>As per Aluminium schedules</i>	Q11
Q20	METAL WINDOWS/ LOUVRES/ SCREENS/ ROOFLIGHTS	Q

Q20/320 ALUMINIUM WINDOWS	<i>As per Aluminium schedules</i>	Q20
Q20/370 METAL LOUVRES	<i>As per schedule</i>	Q20
Q20/390 BURGLAR PROOFING	<p><i>Frame 1: 50 x 5mm steel flat plate frame with mitred corner joints with 12mm diameter holes for M10 bolts.</i></p> <p><i>Mesh: Steelected Bestfence (or similar approved) powder coated Universal Fence Panel with 50mm x 50mm aperture and 4mm thick wire diameter in flush cut sheets of 1200mm x 2400mm.</i></p> <p><i>Frame 2: 50 x 5mm steel flat plate frame with mitred corner joints with 12mm diameter holes for M10 bolts, with 50mm x 150mm x 5mm flat steel plate with 12mm diameter holes for M10 anchor bolts</i></p>	Q20
Q20/340 ROOF LIGHTS	<p><i>Global Roofing (or similar approved) Solutions Sungazer Standard 5mm thick perspex sun harvester, size 1000mm x 600mm, installed in accordance with manufacturer's recommendations.</i></p> <ul style="list-style-type: none"> • <i>Product: Sungazer Standard</i> • <i>Size: 1000mm x 600mm</i> • <i>Colour: clear with prismatic characteristics</i> • <i>Shape: pyramidal dome</i> • <i>Dome with Fresnell lensing: 5mm UV stabilised Perspex</i> • <i>Weight: 16kg per unit</i> 	Q20
Q21 Q21/310	METAL DOORS/ SHUTTERS/ HATCHES DOORS STEEL	Q Q21
Q21/320	DOOR FRAMES STEEL	Q21
	<i>Double Door Robmeg 1,6mm double rebate Grey Oxide Primer pressed steel screeded door frame, to suit door size 1511 x 2032mm high, for 230mm wall.</i>	Q21
	<i>Double Door Robmeg 1,6mm double rebate Grey Oxide Primer pressed steel screeded door frame, to suit door size 1511 x 2032mm high, for 115mm wall.</i>	Q21
	<i>Single Door Robmeg 1,6mm Grey Oxide Primer pressed steel screeded door frame, to suit door size 813 x 2032mm high, for 230mm wall.</i>	Q21
	<i>Single Door Robmeg 1,6mm Grey Oxide Primer pressed steel screeded door frame, to suit door size 813 x 2032mm high, for 115mm wall.</i>	Q21
Q21/370 ANTI-BANDIT DOOR	<i>As per door schedule</i>	Q21
Q21/420 ROLLER SHUTTERS TO ACCESS DOORS	<i>As per door schedule</i>	Q21
Q22 Q22/140 Q22/140 Staircases	STAIRS/ WALKWAYS/ HANDRAILS/ BALUSTRADES BALUSTRADE SYSTEM TO STAIR <i>Mild steel hand rail bolted to walls</i>	Q Q22 Q22
Q22/150 HANDRAIL SYSTEMS RAISED LEVELS	<i>Vital Engineering (or similar approved) Maclock heavy duty, red oxide primed mild steel industrial railings, code HS 3A MS H RO, consisting of 1000mm high, 90° 48mm Ø x 4.0mm G90 stanchions spaced at 1400mm centres, with 38mm Ø x 2.5mm hand/knee rails. Top mounted stanchions to be fitted into stanchion mounting sleeve, drilled and epoxied into concrete slab to a depth of 150mm, minimum 200mm from the edge of the slab.</i>	<i>Stanchions to be secured in place with</i>

*taper pins, including Q22
all necessary bends,
closures, ferrules
etc. as indicated on
drawings.*

Q22/340 OPEN BAR FLOOR GRATINGS TO SERVICE PLATFORMS	<i>Vital Engineering (or similar approved) Vitagrid type A pressure forged VE40 grating with 25 x 3mm plain bearer bars in galvanised mild steel MS G (23kg/m²) including banding on all sides, fixed to bearers (elsewhere specified) with 4 mild steel M6 x 65mm J bolts and fixing clips per panel.</i>	Q22
--	---	-----

R PLASTERING, SCREEDS AND COATINGS		
R10	CEMENT BASED LEVELLING/ WEARING SCREEDS	R
R10/365	CONCRETE WEARING SCREEDS (GRANOLITHIC) TO WAREHOUSE & STORAGE AREAS <i>To be confirmed</i>	R10
R10/400 STRIP MOVEMENT JOINTS FOR DOOR THRESHOLDS	<i>Form thresholds to external doors by removing 75 - 100 mm of the foundation wall over the width of the door opening and casting a concrete topping threshold over the full width of the wall. Cast the threshold against a metal dividing strip under the door, as described below.</i>	R10
R10/650 SCREEDING TO FALLS	<i>Lay guide strips of the sand-cement mix to establish levels. Lay screeds in panels as to match surface bed panels as per structural engineer. Mix proportion of cement-sand screeds must be 1-part cement to 3½ parts sand, or 50 kg (one sack) cement to 130 m³ sand. Add just sufficient water to achieve a plastic, workable consistence.</i>	R10
R20	PLASTERED/ RENDERED/ ROUGHCAST COATINGS	R
R20/110 PLASTERING TO INTERNAL WALLS	<i>12mm thick 1:4 cement plaster finished off with RHINOLITE gypsum plaster applied in accordance with the manufacturer's specification. Apply a sealer coat of bonding liquid before painting.</i>	R20

S TILING		
S10	STONE/ CONCRETE/ QUARRY/ CERAMIC/ MOSAIC TILING	S
S10/310 TILING TO WALLS INTERNALLY	<i>Porcelain Size 200 x 200mm, fixed to internal wall with Tal Gold (or similar approved) Star 6 rapid setting tile adhesive on brickwork (elsewhere specified), using a Tal notched trowel, and 3mm joints continuous in both directions, jointed and flush pointed with Tal Professional tile grout.</i>	S10
S10/310A TILING TO FLOORS INTERNALLY	<i>Porcelain Size 600 x 600mm, fixed to internal floor screed with Tal Gold (or similar approved) Star 6 rapid setting tile adhesive on concrete surface bed (elsewhere specified), using a Tal notched trowel, and 3mm joints continuous in both directions, jointed and flush pointed with Tal Professional tile grout.</i>	S10
S10/310B TILING TO FLOORS WET AREAS	<i>Porcelain Non-slip Size 600 x 600mm, fixed to internal floor screed with Tal Gold (or similar approved) Star 6 rapid setting tile adhesive on concrete surface bed (elsewhere specified), using a Tal notched trowel, and 3mm joints continuous in both directions, jointed and flush pointed with Tal Professional tile grout.</i>	S10
S10/320 TILE SKIRTING	<i>Matching Floor Porcelain Size 100 x 600mm, fixed to internal wall with Tal Gold (or similar approved) Star 6 rapid setting tile adhesive on brickwork (elsewhere specified), using a Tal notched trowel, and 3mm joints continuous in both directions, jointed and flush pointed with Tal Professional tile grout.</i>	S10
S10/386B PROPRIETARY EDGINGS/ COVER STRIPS/ TRANSITION STRIPS	<i>Genesis (or similar approved) interior aluminium access ramp colour Matt Silver (Code: RAA154.81), size 90 x 15mm x 2,5m long on ceramic tile floor covering, fixed to substrate with tile adhesive.</i>	
S10/387A PROPRIETARY STAIR NOSINGS	<i>Genesis (or similar approved) exterior aluminium Tile-In stair nosing with Aluminator™ in Matt Silver (Code: ALM126.81), size 12,5mm x 2,6mm long on ceramic tile stair covering, fixed with contact adhesive and plugged and screwed to tread.</i>	S10
S10/388 PROPRIETARY TILE JOINTS	<i>Expansion Joint Aluminium 10mm tile expansion, fixed with contact adhesive and plugged and screwed to tread. Located and aligned to structural joints. Conformity of Structural vs Tile joint requirements to be coordinated with architect and set out by contractor for approval by all inclusive of a manufacturer's recommendation.</i>	S10

T DRAINAGE, PLUMBING AND PIPED SERVICES		
T10	RAINWATER DRAINAGE SYSTEMS	T
T10/465 RAINWATER STORAGE TANKS	<i>JoJo (or similar approved) 2500L -2 off. To include all pumps, valves, bends and accessories as per specialist specification and installation to comply.</i>	T10
T11	FOUL DRAINAGE ABOVE GROUND	T
T11/310 FLOOR CHANNELS IN WET ROOMS	<i>Rofo Engineering (or similar approved) grade AISI 304 stainless steel RO 125 NW 50 floor drain with square top flange and square cover plate with slots (Code: RO125HNW50SQ - slots), suitable for tiled floor covering, overall size 150mm x 195mm deep, with 50,8mm diameter horizontal waste outlet with mitred bend connected to waste pipe.</i>	T11
T11/365 UPVC PIPEWORK - FOR EXTERNAL DISCHARGE STACKS AND BRANCHES	<i>By Wet Services Engineer</i>	T11
T11/380 GREASE TRAPS AND CONVERTERS	<i>By Wet Services Engineer</i>	T11
T11/390 RODDING EYES EXTERNALLY	<i>By Wet Services Engineer</i>	T11
T12	DRAINAGE BELOW GROUND	T
T12/127	PRIVATE PACKAGED SEPTIC TANK SYSTEMS BY CIVIL ENGINEER	T12
T12/130	PRIVATE PACKAGED SEWAGE TREATMENT SYSTEMS BY CIVIL ENGINEER	T12
T12/407	MANHOLES AND INSPECTION CHAMBERS - CONCRETE TO SEWER TREATMENT PLANT	T12
T12/419	GREASE TRAPS AND CONVERTERS <i>By Wet Services Engineer</i>	T12
T12/460	STORAGE TANKS FOR USE TO BE DETERMINED AT A LATER STAGE	T12
T60	SANITARY APPLIANCES/ FITTINGS	T
T60/110 WC PAN ALL	<i>As per sanitary schedule</i>	T60
T60/112 URINAL ALL	<i>As per sanitary schedule</i>	T60
T60/116 WASH HAND BASIN ALL	<i>As per sanitary schedule</i>	T60
T60/126 SINKS ALL	<i>As per sanitary schedule</i>	T60
T60/138 GRAB RAILS FOR DISABLED PERSONS ALL	<i>Railman Grab Rails 750mm x 206mm Cistern Rail For Protea SR2</i> <i>Railman Grabrails 300mm x 300mm x 300mm Dogleg rail with 2 flanges DL2</i>	T60

T60/140 WASHROOM *As per accessories schedule*
ACCESSORIES ALL

T60

T60/362	BASIN WASTE ALL BASINS	T60
T60/364	BASIN TRAPS ALL BASINS	T60
T60/366	BASIN WATER SUPPLY FITTINGS ALL BASINS	T60
T60/366A	BASIN WATER SUPPLY FITTINGS	T60
T60/374	SHOWER WASTE/ TRAP ALL SHOWERS	T60
T60/374A	SHOWER WASTE/ TRAP	T60
T60/376	SHOWER WATER SUPPLY FITTINGS	T60
T60/376A	SHOWER WATER SUPPLY FITTINGS	T60
T60/380	SINK/ WASH TROUGH WASTES ALL SINKS	T60
T60/380A	SINK/ WASH TROUGH WASTES	T60
T60/382	SINK/ WASH TROUGH/ APPLIANCES TRAPS	T60
T60/382A	SINK/ WASH TROUGH/ APPLIANCES TRAPS	T60
T60/384	SINK/ WASH TROUGHS/ APPLIANCES WATER SUPPLY FITTINGS	T60
T60/384A	SINK/ WASH TROUGHS/ APPLIANCES WATER SUPPLY FITTINGS	T60
T60/386	BIB TAPS HOSE BIBTAP WITH LOCKSHIELD	T60
T60/398	GRAB RAILS FOR DISABLED PERSONS TOILETS GENERIC	T60
T60/398A	GRAB RAILS FOR DISABLED PERSONS TOILETS	T60
T60/398B	GRAB RAILS FOR DISABLED PERSONS TOILETS	T60
T60/400A	ACCESSORIES SINGLE SOURCE MANUFACTURER	T60
T60/414	MIRRORS ALL	T60
T60/414A	MIRRORS <i>6mm thick float glass mirrors with polished edges</i>	T60
T60/416	PAPER TOWEL DISPENSERS	T60
T60/416A	PAPER TOWEL DISPENSERS	T60
T60/418A	SANITARY TOWEL DISPOSAL BINS	T60
T60/426	SOAP DISPENSERS ALL	T60
T60/426A	SOAP DISPENSERS	T60
T60/430	TOILET PAPER HOLDERS ALL	T60
T60/430A	TOILET PAPER HOLDERS	T60
T60/434	TOWEL RAILS ALL	T60
T60/440A	WARM AIR HAND DRIERS	T60
T60/442A	WASTE BINS	T60
T90	HOT AND COLD WATER SUPPLY SYSTEMS - DOMESTIC	T
T90/332A	INSTANTANEOUS WATER HEATERS, ELECTRIC	T90

W	GLAZING	
----------	----------------	--

W10	GENERAL GLAZING AND MIRRORS	W
	<i>Glazing in compliance with SABS 0400 . Glazing compliance certificate to be issued by glazier after installation.</i>	
W10/315	CLEAR FLOAT GLASS	W10
W10/330 LAMINATED GLASS SAFETY GLASS (NS)	<i>Allow for 6.38mm Laminated safety glass</i>	W10
W10/380 GLASS MIRRORS FOR ALL ABLUTION FACILITIES	<i>6mm thick float glass mirrors with polished edges</i>	W10

X	PAINTWORK	
----------	------------------	--

X10	INTERNAL & EXTERNAL PAINTWORK	X
X10/310 SAMPLE PAINT PANEL	<i>Provide for the painting of 4 sample panels (2 sqm per panel) for Architect' consideration.</i>	X10
X10/310A INTERNAL WALLS	<i>Plascon Cashmere to interior plaster. (or similar approved) To prep and apply to manufacturers specification inclusive of colour codes and maintainance cyles.</i>	X10
X10/310B EXTERNAL WALLS	<i>Plascon Plascon Wall & All to exterior plaster. (or similar approved) To prep and apply to manufacturers specification inclusive of colour codes and maintainance cyles.</i>	X10
X10/311 METAL INTERNAL	<i>Plascon Velvagio Satin to interior new redoxide primed mild steel (or similar approved) To prep and apply to manufacturers specification inclusive of colour codes and maintainance cyles.</i>	X10

Y	EXTERNAL WORKS	
----------	-----------------------	--

Y10	PRECAST EXTERNAL WORKS	Y
Y10/310 PRECAST CONCRETE SPLASH BLOCKS	<i>Technicrete (or equal) concrete splash blocks 300-600mm length at all downpipe shoes. installed according to manufacturers specification in strict accordance with the Civil Enginners specification for stormwater management.</i>	Y10
Y10/320 PRECAST CONCRETE PAVING GENERAL	<i>Technicrete (or equal) interlocking pavers. To include also a 1m apron around building with precast garden kerb edging to natural ground installed according to manufacturers specification in strict accordance with the Civil Enginners specification for stormwater management.</i>	Y10

A0

GAITENG: Unit 2, 107 Sovereign Drive, The Gateway, Midrand, Johannesburg, Gauteng
LIMPOPO: 45 Barzani Drive, Potchefstroom, Limpopo
LEMEG ARCHITECTS CC: 1115 1986th Road, 231 MEMBERS: EV Barnard (P/Arch LINDSAA FAVS) | KS Lelani (P/Arch SAALU)
www.lemeg.com

LEMEG ARCHITECTS

LIMPOPO PROVINCIAL GOVERNMENT
DEPARTMENT OF PUBLIC WORKS, ROADS & INFRASTRUCTURE

DISCLAIMER
THE REQUIREMENTS AND CONDITIONS SET OUT IN THIS DOCUMENT SHALL NOT APPLY FOR BE IMPLEMENTED TO THE EXTENT THAT THEY DO NOT MEET THE REQUIREMENTS OF APPLICABLE LAWS AND REGULATIONS. IN ALL CASES, ALL APPLICABLE LEGAL AND REGULATORY REQUIREMENTS MUST BE MET WHEN CONDUCTING ACTIVITIES WITH THIS DOCUMENT.

CLIENT: Limpopo Department of Public Works, Roads & Infrastructure
PROJECT NUMBER: Z101
WORK PACKAGE: W04
DATE: 2021/10/22 09:11:33
AUTHOR: THC
PROJECT LEADER: AAB
DRAFTER NUMBER: []

REVISION
DRAWING NUMBER: AE - 1 - 1000 - K00
NEW LIBRARIES
VARIOUS OTHER PLANS
TENDER/PROCUREMENT

Book space	276 m ²	Staff WC	2 m ²
Childrens room	27 m ²	Staff WC	2 m ²
Computer room	24 m ²	Store	2 m ²
DB	2 m ²	Store / Workroom	18 m ²
Duct	1 m ²	Study space	29 m ²
Duct	1 m ²	Waiting area	9 m ²
Duct	1 m ²		
Duct	1 m ²		
Duct	1 m ²		
Female ablutions	12 m ²		
Foyer	37 m ²	Mechanical Room	21 m ²
Foyer	3 m ²	Mechanical Yard	22 m ²
Hall	58 m ²	Outdoor courtyard	71 m ²
Kitchen	5 m ²	Outdoor courtyard	66 m ²
Librarians' Office	25 m ²	Outdoor play area	21 m ²
Male ablutions	12 m ²	Refuse Yard	9 m ²
Passage	11 m ²	Service Yard	13 m ²
Reception	14 m ²		223 m ²
			810 m ²

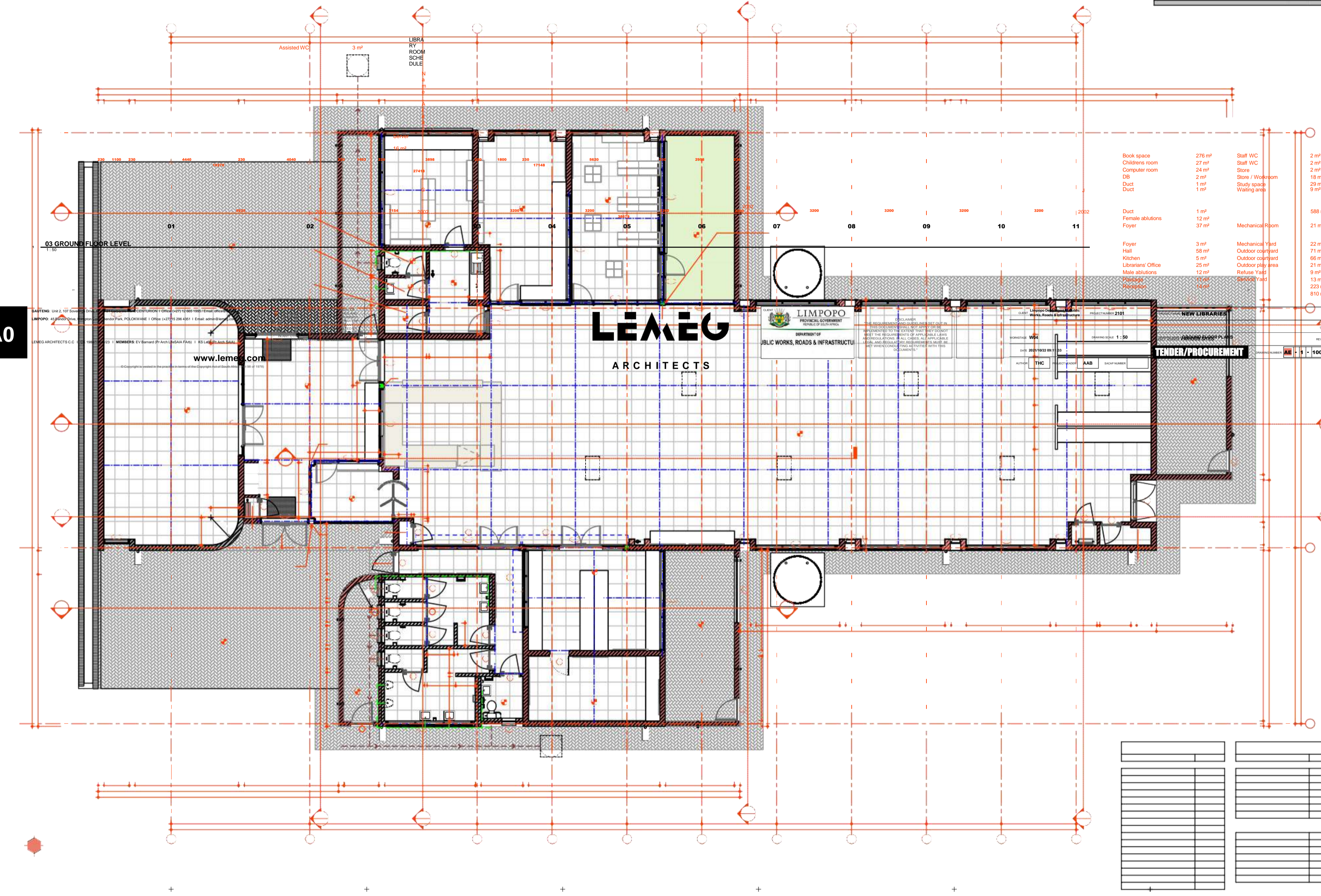

01

02

03

04

05

06

07

08

09

10

11

F 2001

G 2002

H 2002

J 2002

M11/362 ACCESS PANELS TO FLUSH PLATERED CEILINGS IN POSITIONS INDICATED ON DRAWINGS

BEAM ABOVE

BEAM ABOVE

BEAM ABOVE

M30/310 SUSPENDED CEILING SYSTEM

CEILING +102,680,00

M30/310 SUSPENDED CEILING SYSTEM

CEILING +102,680,00

M30/310 SUSPENDED CEILING SYSTEM

CEILING +102,680,00

M11/362 ACCESS PANELS TO FLUSH PLATERED CEILINGS IN POSITIONS INDICATED ON DRAWINGS

M30/310 SUSPENDED CEILING SYSTEM

CEILING +102,680,00

LEVEL ABOVE

BEAM ABOVE

M30/310 SUSPENDED CEILING SYSTEM

CEILING +102,740,00

M30/310 SUSPENDED CEILING SYSTEM

CEILING +103,740,00

BRICK ON EDGE

1092

M11/130 ACOUSTIC CEILINGS

CEILING +103,685,00

020348 ROOF LIGHTS

020348 ROOF LIGHTS

020348 ROOF LIGHTS

020348 ROOF LIGHTS

E 2001

D 2001

C 2000

B 2000

A 2000

A

B

D 2001

C 2000

B 2000

C

J 2002

10

11

Key Value

Keynote Legend

Keynote Text

M11/130 ACOUSTIC CEILINGS

M11/362 ACCESS PANELS TO FLUSH PLATERED

CEILINGS IN POSITIONS INDICATED ON DRAWINGS

OWAcoustic Constellation Premium biologically absorbable mineral wool ceiling tiles, NRC - 0,70, CAC- 33dB, Fire classification A2-s1, d0, weight - 4,5 kg/m², size 1200 x 600 x 15mm with Square-edge and white painted finish, laid on fire rated OWAconstruct S15 exposed demountable T15 suspension system, comprising galvanised main tees and cross tees with main tees suspended by means of galvanised hangers at centres not exceeding 1200mm, and all installed to manufacturer's instructions.
OWAconstruct Shadowline W-trim, plugged and screwed at centres not exceeding 200mm.
Extra over ceiling for Pelican Bottom Hung Access Panel comprising matt white powder coated aluminium T-Frame 600 x 1200mm, fitted flush to ceiling with and including screw fixing through frame into JUMBO® Grid / Branding. All installations to be done in accordance with manufacturer's recommendations.

M11/362 ACCESS PANELS TO FLUSH PLATERED CEILINGS IN POSITIONS INDICATED ON DRAWINGS

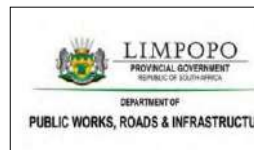

A0

GAUTENG: Unit 2, 107 Sovereign Drive, Route 21 Corporate Park, CENTURION | Office: (+27) 12 665 1995 / Email: office@lemeg.com
LIMPOPO: 45 Bendor Drive, Hampton Court, Bendor Park, POLOKWANE | Office: (+27) 15 296 4351 | Email: admin@lemeg.com

LEMEG ARCHITECTS CC | CK 1988/12840/23 | MEMBERS: EV Barnard (P/Arch SA/SA FA/SA) | KS Lefth (P/Arch SA/SA)

www.lemeg.com

© Copyright is vested in the practice in terms of the Copyright Act of South Africa (Act 98 of 1978)

ALL RIGHTS RESERVED. THE COPYING OF THIS DRAWING (INCLUDING ALL ATTACHED AND INCORPORATED DOCUMENTS) IS THE PROPERTY OF LEMEG. NEITHER THE FORM OR ANY OF IT MAY BE USED OR REPRODUCED IN ANY MANNER WHATSOEVER OR INCORPORATED BY ANY REFERENCE OR IN ANY MANNER WHATSOEVER IN ANY OTHER DOCUMENT, PROJECT OR FOR ANY OTHER PURPOSE.

DISCLAIMER
"THE REQUIREMENT AND GUIDELINES SET OUT IN THIS DOCUMENT SHALL NOT APPLY OR BE IMPLEMENTED TO THE EXTENT THAT THEY DO NOT MEET THE REQUIREMENTS OF APPLICABLE LAWS AND REGULATIONS. IN ALL CASES, ALL APPLICABLE LEGAL AND REGULATORY REQUIREMENTS MUST BE MET WHEN CONDUCTING ACTIVITIES WITH THIS DOCUMENTS."

CLIENT: Limpopo Department of Public Works, Roads & Infrastructure

WORKSTAGE: W04

DATE: 2021/09/01 16:59:14

AUTHOR: AAB PROJECT LEADER: AAB SACOP NUMBER:

PROJECT NUMBER: 2101

DRAWING SCALE: 1 : 50

PROJECT ADDRESS: VARIOUS SITES

DRAWING NUMBER: AE - 1 - 1100 - X00

PROJECT NAME: NEW LIBRARIES

DRAWING NAME: CEILING PLAN

REVISION:

TENDER/PROCUREMENT

M30/310 SUSPENDED CEILING SYSTEM

Q20/340 ROOF LIGHTS

Lay Gyproc Gyprex Fissured 1200mm x 600mm ceiling tile into the Donn ceiling grid. Ceiling grid consisting of Donn Wall Angle (SM25/M6) fixed to the perimeter wall using fixings at 300mm centres. Space Donn Main Tees T38 FR at 1200mm centres. Suspend main tees using Donn Pre-stretched Galvanised Hanger wire 2.5mm thick or Donn hanger strap 19mm at 1200mm centres. Donn Pre-stretched Galvanised Hanger wire shall be put through the main tees hole and would wind 3 times around itself. 2 steel pop-rivets or one Donn Water Head Tek screw 13mm shall be used to fix the hanger strap to the main tees web. Install Donn Cross Tees T38V/T32V (1200 long) at 600mm centres to create a 1200mm x 600mm ceiling grid. Main tee should be fixed to the wall using angle cleats.
• Ceiling System: Gyproc Exposed Ceiling System Gyprex Fissured 1200 x 600mm
• Ceiling Grid: exposed ceiling grid.

Global Roofing (or similar approved) Solutions Sungazer Standard 5mm thick perspex sun harvester, size 1000mm x 600mm, installed in accordance with manufacturer's recommendations.
• Product: Sungazer Standard
• Size: 1000mm x 600mm
• Colour: clear with prismatic characteristics
• Shape: pyramidal dome
• Dome with Fresnell lensing: 5mm UV stabilised Perspex
• Weight: 16kg per unit.

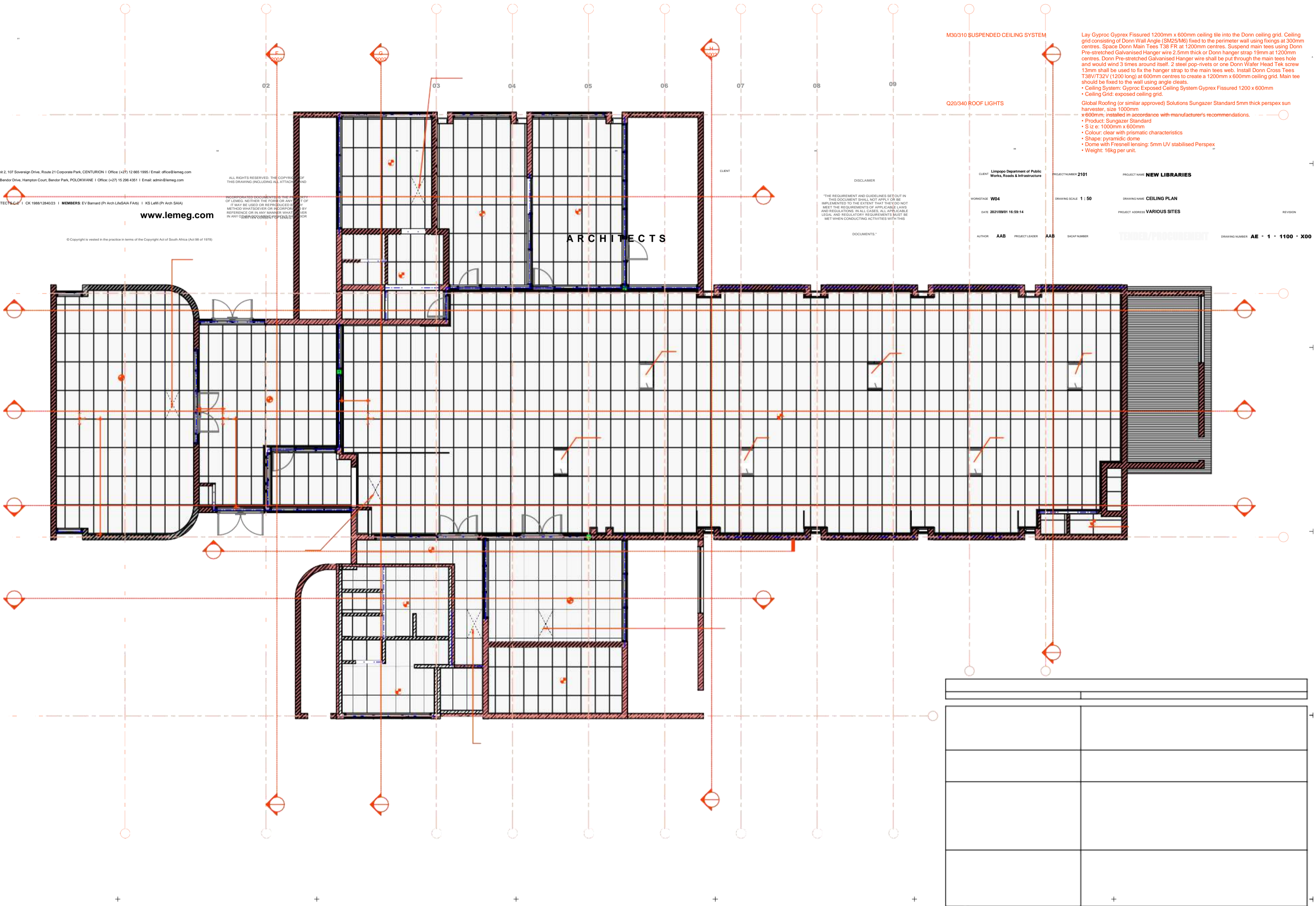

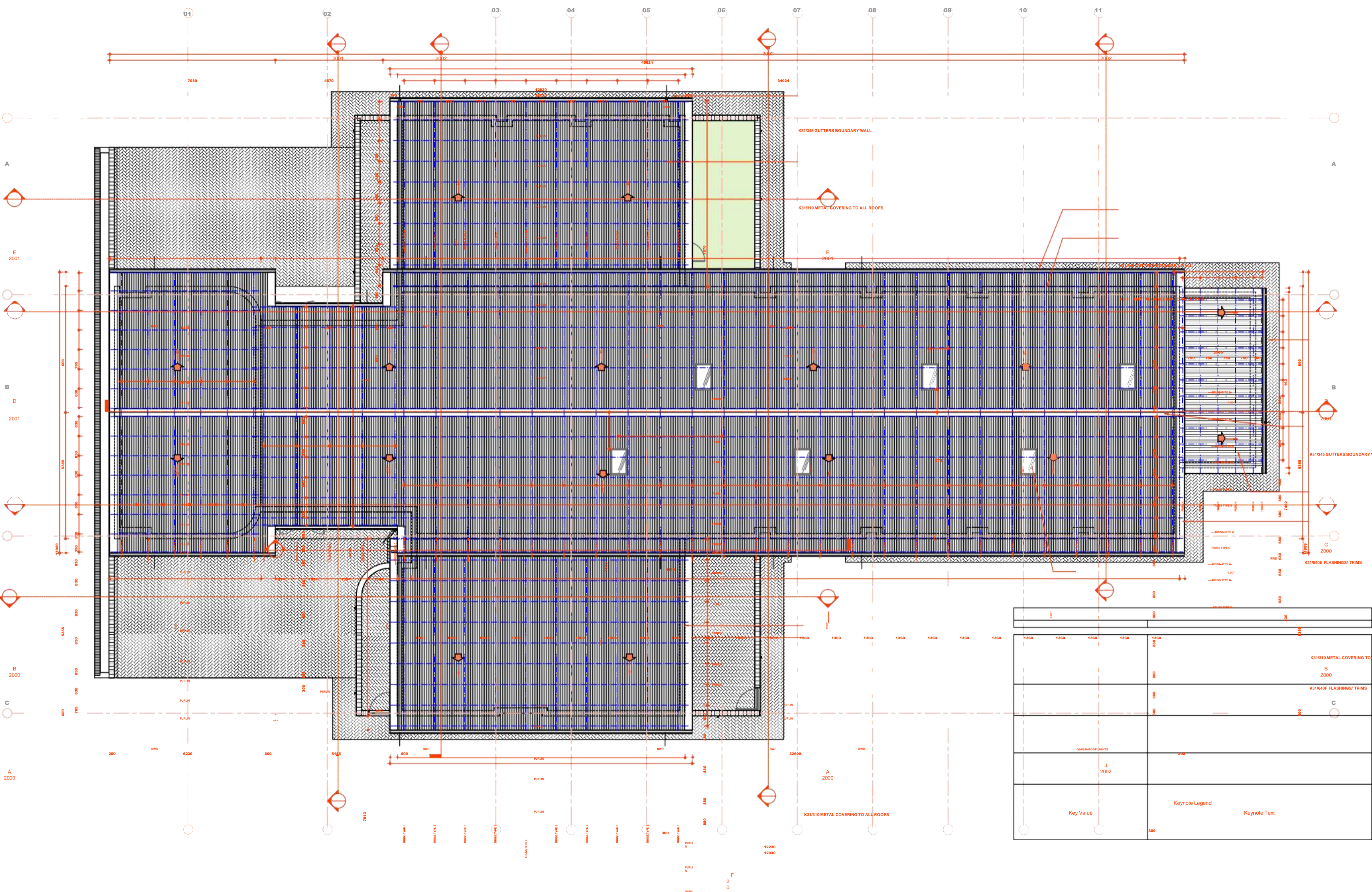

Key Value	Keynote Legend	Keynote Text
B 2000	K31/310 METAL COVERING TO ALL ROOFS	
C	K31/640F FLASHINGS/ TRIMS	
J 2002	G20040 ROOF LIGHTS	



K31/64
OF
FLASHING
NGS/
TRIMS

K31/3
10
META
L
COVE
RING
TO
ALL
ROO
FS

K31/3
45
GUTT
ERS
BOUN
DARY
WALL

K31/6
40E
FLAS
HING
S/
TRIM
S

K31/6
40F
FLAS
HING
S/
TRIM
S

Q20/3
40
ROOF
LIGH
TS

Global Roofing Solutions (or similar approved) 0.80mm thick Galvanised steel Z200 spelter ISQ550 Chromadek® Dark Dolphin finish top coat and Pebble Grey backing coat Galvanised steel girth 550mm ridge cap (Code: FK73), fixed in accordance with manufacturer's specifications.
• Brand: ArcelorMittal
• Climatic Condition: inland - C1/C2 Low Corrosion Risk
Global Roofing Solutions (or similar approved) 0.80mm thick Galvanised steel Z200 spelter ISQ550 Chromadek® Charcoal Grey finish top coat and Pebble Grey backing coat Galvanised steel girth 580mm barge (Code: FK713) fixed in accordance with manufacturer's specifications.
• Brand: ArcelorMittal
• Climatic Condition: inland - C1/C2 Low Corrosion Risk
Global Roofing (or similar approved) Solutions Sungazer Standard 5mm thick perspex sun harvester, size 1000mm x 600mm, installed in accordance with manufacturer's recommendations.
• Product: Sungazer Standard
• Size: 1000mm x 600mm
• Colour: clear with prismatic characteristics
• Shape: pyramidal dome

oated Chromadek seamless gutter, size 150 x 125 x 0.5mm thick in colour Armour Grey including matching rivet-fixed mitres and end caps internally sealed using Silicon Mastic, hung by nail fixed internal aluminium hangers at 800mm centres with rectangular/fluted downpipes, size 85mm Dia x 0.5mm thick in colour Armour Grey fixed to walls with pre-painted downpipe cleats using nail-in anchor fixings.

Global Roofing Solutions (or similar approved) 0.80mm thick Galvanised steel Z200 spelter ISQ550 Chromadek® Dark Dolphin finish top coat and Pebble Grey backing coat Galvanised steel girth 550mm ridge cap (Code: FK73), fixed in accordance with manufacturer's specifications.
• Brand: ArcelorMittal
• Climatic Condition: inland - C1/C2 Low Corrosion Risk
Global Roofing Solutions (or similar approved) 0.80mm thick Galvanised steel Z200 spelter ISQ550 Chromadek® Charcoal Grey finish top coat and Pebble Grey backing coat Galvanised steel girth 580mm barge (Code: FK713) fixed in accordance with manufacturer's specifications.
• Brand: ArcelorMittal
• Climatic Condition: inland - C1/C2 Low Corrosion Risk
Global Roofing (or similar approved) Solutions Sungazer Standard 5mm thick perspex sun harvester, size 1000mm x 600mm, installed in accordance with manufacturer's recommendations.
• Product: Sungazer Standard
• Size: 1000mm x 600mm
• Colour: clear with prismatic characteristics
• Shape: pyramidal dome

H 2002



REVISION SCHEDULE			
Number	Description	Date	Revised To

Key Value	Keynote Legend	Keynote Text
F10/212 DESIGN OF STRUCTURAL CONCRETE	Materials, drawings, specification, protective equipment and quality assurance must be according to the engineer	
H10/310 CLAY FACING BRICKWORK ABOVE DPC	Standard: SANS 227. - Classification: [FBX]. - Exposure zone: [Zone 1-2]. - Efflorescence: [Normal grade]. - Manufacturer: [Corobrik® or similar approved]. - Product reference: [Country Classic]. - Work sizes (length x width x height): [222 x 106 x 73 mm]. - Special shapes: [As shown on drawings]. - Foundation and loadbearing brickwork: NFxE clay bricks (20MPa nominal compressive strength) in class 2 mortar – in stretcher bond. - Perpendicular and horizontal joints: 6mm deep square recessed polished joints.	
H10/320 CLAY FACING BRICKWORK ABOVE DPC	Standard: SANS 227. - Classification: [FBX]. - Exposure zone: [Zone 1-2]. - Efflorescence: [Normal grade]. - Manufacturer: [Corobrik® or similar approved]. - Product reference: [Onyx]. - Work sizes (length x width x height): [222 x 106 x 73 mm]. - Special shapes: [As shown on drawings]. - Foundation and loadbearing brickwork: NFxE clay bricks (20MPa nominal compressive strength) in class 2 mortar – in soldier bond. - Perpendicular and horizontal joints: 6mm deep square recessed polished joints.	
K31/310 METAL COVERING TO ALL ROOFS	Global Roofing Solutions (or similar approved) 0.58mm thick 700mm cover Klip-Tile™ profile Chromadek® Z200 spelter ISO550 Dark Dolphin finish top coat and Pebble Grey backing coat Galvanised steel roof sheeting, fixed to steel intermediate purlins at MAX 2500mm centres and eaves and ridge purlins at MAX 2100mm centres using KL700 plus clips fixed with 10No. 16 x 16mm long self-drilling wafer head PH2 screws, No. 3 drill point fasteners, all in accordance with the manufacturer's specifications. • Brand: ArcelorMittal • Climatic Condition: Inland - C1/C2 Low Corrosion Risk.	
K31/345 GUTTERS BOUNDARY WALL	Profile Colorbond pre-coated Chromadek seamless gutter, size 150 x 125 x 0.5mm thick in colour Armour Grey including matching rivet-fixed mitres and end caps internally sealed using Silicon Mastic, hung by nail fixed internal aluminium hangers at 600mm centres with rectangular fluted downpipes, size 85mm Dia x 0.5mm thick in colour Armour Grey fixed to walls with pre-painted downpipe cleats using nail-in anchor fixings.	
K31/380A THERMAL INSULATION	Install Isover 135mm thick Aerolite non-combustible light weight Glasswool thermal ceiling insulation. • R-value: 3.38m² KW • Thermal conductivity: 0.04 W/m²K.	
K31/640F FLASHINGS/ TRIMS	Global Roofing Solutions (or similar approved) 0.80mm thick Galvanised steel Z200 spelter ISO550 Chromadek® Charcoal Grey finish top coat and Pebble Grey backing coat Galvanised steel, girth 580mm barge (Code: FK713) fixed in accordance with manufacturer's specifications. • Brand: ArcelorMittal • Climatic Condition: Inland - C1/C2 Low Corrosion Risk	
L10/310 STRUCTURAL SOFTWOOD (GRADED DIRECT TO STRENGTH CLASS) FOR STRUCTURAL USE GENERALLY	All solid softwood structural timber must be stress-graded sawn softwood structural timber to comply with SABS 1783. Timber must be ordered in the size in which it must be used. The grade must be marked on each piece of timber.	
M11/130 ACOUSTIC CEILINGS	OWAcoustic Constellation Premium biologically absorbable mineral wool ceiling tiles, NRC - 0.70, CAC - 33dB, Fire classification A2-s1, d0, weight - 4.5 kg/m², size 1200 x 600 x 15mm with Square-edge and white painted finish, laid on fire rated OVAconstruc S15 exposed demountable T15 suspension system, comprising galvanised main tees and cross tees with main tees suspended by means of galvanised hangers at centres not exceeding 1200mm, and all installed to manufacturer's instructions. OWAcconstruc Shadowline W-trim, plugged and screwed at centres not exceeding 200mm.	
M30/310 SUSPENDED CEILING SYSTEM	Lay Gyproc Gyproc Fissured 1200mm x 600mm ceiling tile into the Donn ceiling grid. Ceiling grid consisting of Donn Wall Angle (SM25/M6) fixed to the perimeter wall using fixings at 300mm centres. Space Donn Main Tees T38 FR at 1200mm centres. Suspend main tees using Donn Pre-stretched Galvanised Hanger wire 2.5mm thick or Donn hanger strap 19mm at 1200mm centres. Donn Pre-stretched Galvanised Hanger wire shall be put through the main tees hole and would wind 3 times around itself. 2 steel pop-rivets or one Donn Wafer Head Tek screw 13mm shall be used to fix the hanger strap to the main tees web. Install Donn Cross Tees T38V/T32V (1200 long) at 600mm centres to create a 1200mm x 600mm ceiling grid. Main tee should be fixed to the wall using angle cleats. • Ceiling System: Gyproc Exposed Ceiling System Gyproc Fissured 1200 x 600mm • Ceiling Grid: exposed ceiling grid.	
P10/120 PREFABRICATED LIGHT GAUGE STEEL ROOF TRUSSES TO ROOF SECTIONS	Materials, drawings, specification, protective equipment and quality assurance must be according to the engineer	



SECTION A-A
1:50

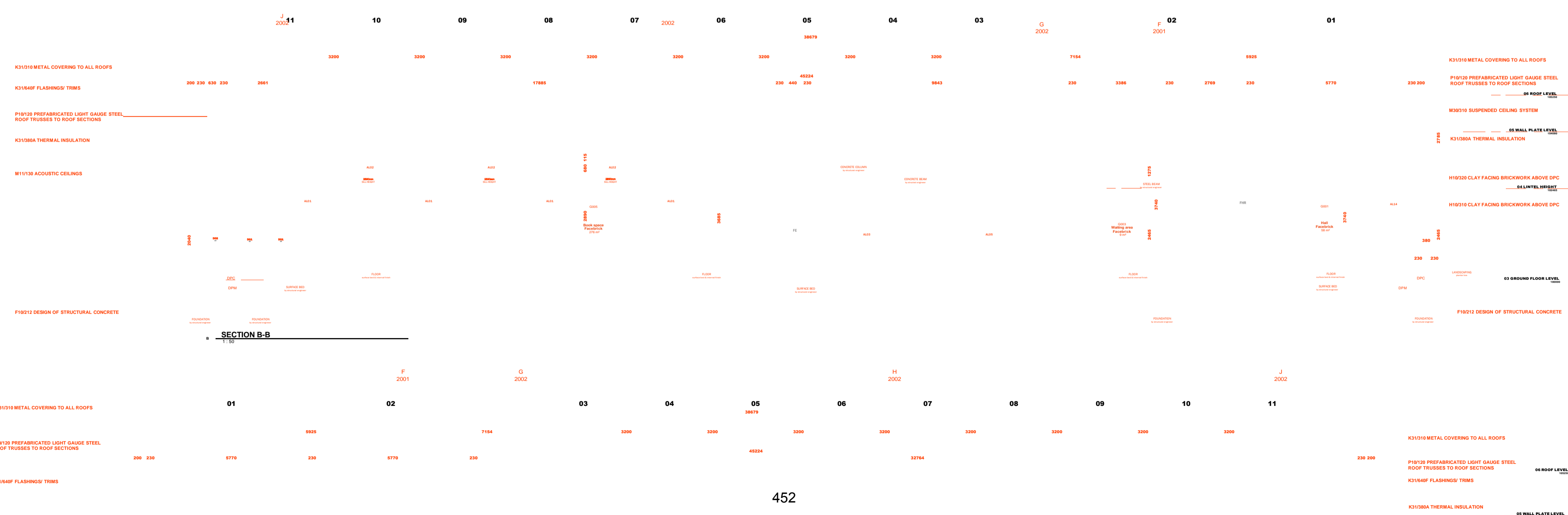

SECTION B-B
1:50

Key Value	Keynote Legend	Keynote Text
F10/212 DESIGN OF STRUCTURAL CONCRETE		Materials, drawings, specification, protective equipment and quality assurance must be according to the engineer
H10/310 CLAY FACING BRICKWORK ABOVE DPC		Standard: SANS 227. - Classification: [FBX]. - Exposure zone: [Zone 1-2]. - Efflorescence: [Normal grade]. Manufacturer: [Corobrik® or similar approved]. - Product reference: [Country Classic]. - Work sizes (length x width x height): [222 x 106 x 73 mm]. - Special shapes: [As shown on drawings]. - Foundation and loadbearing brickwork: NFXE clay bricks (20MPa nominal compressive strength) in class 2 mortar – in stretcher bond. - Perpendicular and horizontal joints: 6mm deep square recessed polished joints.
H10/320 CLAY FACING BRICKWORK ABOVE DPC		Standard: SANS 227. - Classification: [FBX]. - Exposure zone: [Zone 1-2]. - Efflorescence: [Normal grade]. Manufacturer: [Corobrik® or similar approved]. - Product reference: [Onyx]. - Work sizes (length x width x height): [222 x 106 x 73 mm]. - Special shapes: [As shown on drawings]. - Foundation and loadbearing brickwork: NFXE clay bricks (20MPa nominal compressive strength) in class 2 mortar – in stretcher bond. - Perpendicular and horizontal joints: 6mm deep square recessed polished joints.
K31/310 METAL COVERING TO ALL ROOFS		Global Roofing Solutions (or similar approved) 0.58mm thick 700mm cover Klip-Tile™ profile Chromadek® Z200 spelter ISQ550 Dark Dolphin finish top coat and Pebble Grey backing coat Galvanised steel roof sheeting, fixed to steel intermediate purlins at MAX 2500mm centres and eaves and ridge purlins at MAX 2100mm centres using KL700 plus clips fixed with 10No. 16 x 16mm long self-drilling wafer head PH2 screws, No. 3 drill point fasteners, all in accordance with the manufacturer's specifications. - Brand: ArcelorMittal - Climatic Condition: inland - C1/C2 Low Corrosion Risk.
K31/345 GUTTERS BOUNDARY WALL		Profile Colorbond pre-coated Chromadek seamless gutter, size 150 x 125 x 0.5mm thick in colour Armour Grey including matching rivet-fixed mitres and end caps internally sealed using Silicon Mastic, hung by nail fixed internal aluminium hangers at 800mm centres with rectangular fluted downpipes, size 85mm Dia x 0.5mm thick in colour Armour Grey fixed to walls with pre-painted downpipe cleats using nail-in anchor fixings.
K31/380A THERMAL INSULATION		Install Isover 135mm thick Aerolite non-combustible light weight Glasswool thermal ceiling insulation. - R-value: 3.38m²K/W - Thermal conductivity: 0.04 W/m²K
K31/640E FLASHINGS/ TRIMS		Global Roofing Solutions (or similar approved) 0.80mm thick Galvanised steel Z200 spelter ISQ550 Chromadek® Dark Dolphin finish top coat and Pebble Grey backing coat Galvanised steel, girth 550mm ridge cap (Code: FK73), fixed in accordance with manufacturer's specifications. - Brand: ArcelorMittal - Climatic Condition: inland - C1/C2 Low Corrosion Risk
K31/640F FLASHINGS/ TRIMS		Global Roofing Solutions (or similar approved) 0.80mm thick Galvanised steel Z200 spelter ISQ550 Chromadek® Charcoal Grey finish top coat and Pebble Grey backing coat Galvanised steel, girth 580mm barge (Code: FK713) fixed in accordance with manufacturer's specifications. - Brand: ArcelorMittal - Climatic Condition: inland - C1/C2 Low Corrosion Risk
L10/120 PREFABRICATED TIMBER ROOF TRUSS		114 x 50mm thick pre-fabricated SA Pine roof trusses as indicated at max 1200mm centres complete with cross bracing supply ENG certificate
M11/130 ACOUSTIC CEILINGS		OWAcoustic Constellation Premium biologically absorbable mineral wool ceiling tiles, NRC - 0.70, CAC - 33dB, Fire classification A2-s1, d0, weight - 4.5 kg/m², size 1200 x 600 x 15mm with Square-edge and white painted finish, laid on fire rated OWAconstruct S15 exposed demountable T15 suspension system, comprising galvanised main tees and cross tees with main tees suspended by means of galvanised hangers at centres not exceeding 1200mm, and all installed to manufacturer's instructions. OWAconstruct Shadowline W-trim, plugged and screwed at centres not exceeding 200mm.
M30/310 SUSPENDED CEILING SYSTEM		Lay Gyproc Gyplex Fissured 1200mm x 600mm ceiling tile into the Donn ceiling grid. Ceiling grid consisting of Donn Wall Angle (SM25/M6) fixed to the perimeter wall using fixings at 300mm centres. Space Donn Main Tees T38 FR at 1200mm centres. Suspend main tees using Donn Pre-stretched Galvanised Hanger wire 2.5mm thick or Donn hanger strap 19mm at 1200mm centres. Donn Pre-stretched Galvanised Hanger wire shall be put through the main tees hole and would wind 3 times around itself. 2 steel pop-rivets or one Donn Wafer Head Tek screw 13mm shall be used to fix the hanger strap to the main tees web. Install Donn Cross Tees T38V/T32V (1200 long) at 600mm centres to create a 1200mm x 600mm ceiling grid. Main tee should be fixed to the wall using angle cleats. - Ceiling System: Gyproc Exposed Ceiling System Gyplex Fissured 1200 x 600mm - Ceiling Grid: exposed ceiling grid.
P10/110 HOT ROLLED STEEL FRAMING SYSTEM		Materials, drawings, specification, protective equipment and quality assurance must be according to the engineer
P10/120 PREFABRICATED LIGHT GAUGE STEEL ROOF TRUSSES TO ROOF SECTIONS		Materials, drawings, specification, protective equipment and quality assurance must be according to the engineer

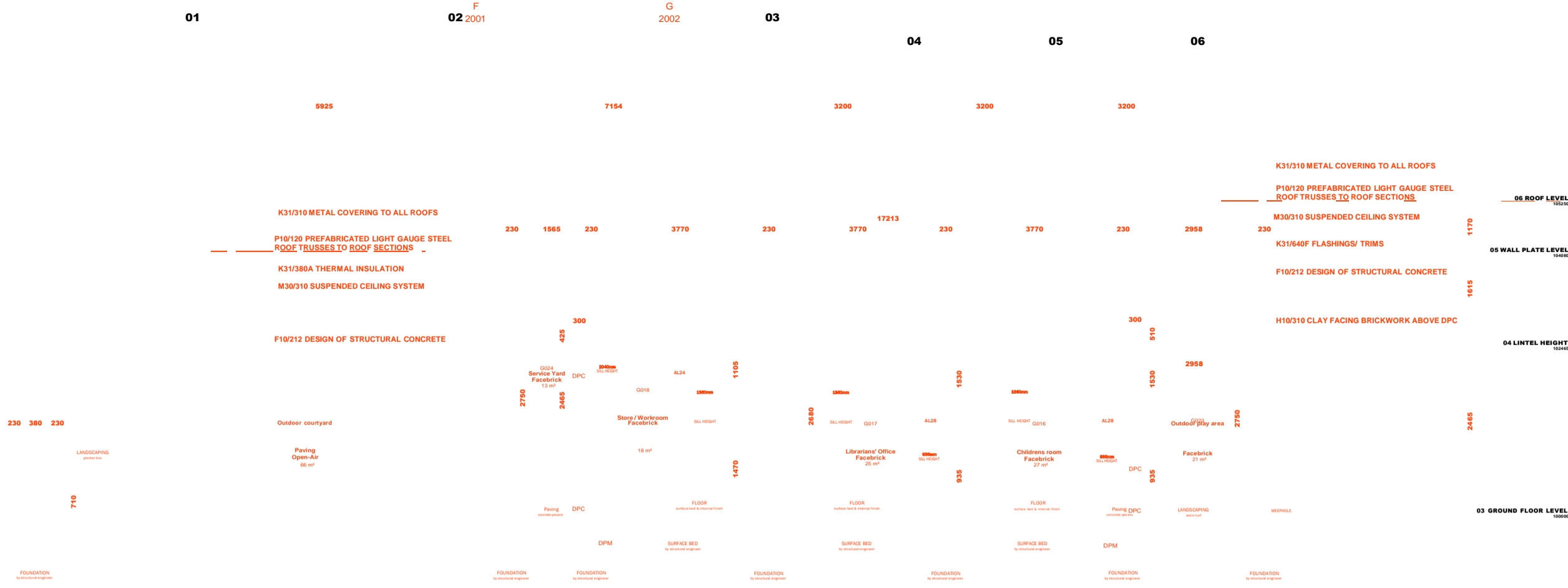

SECTION E-E
1:50

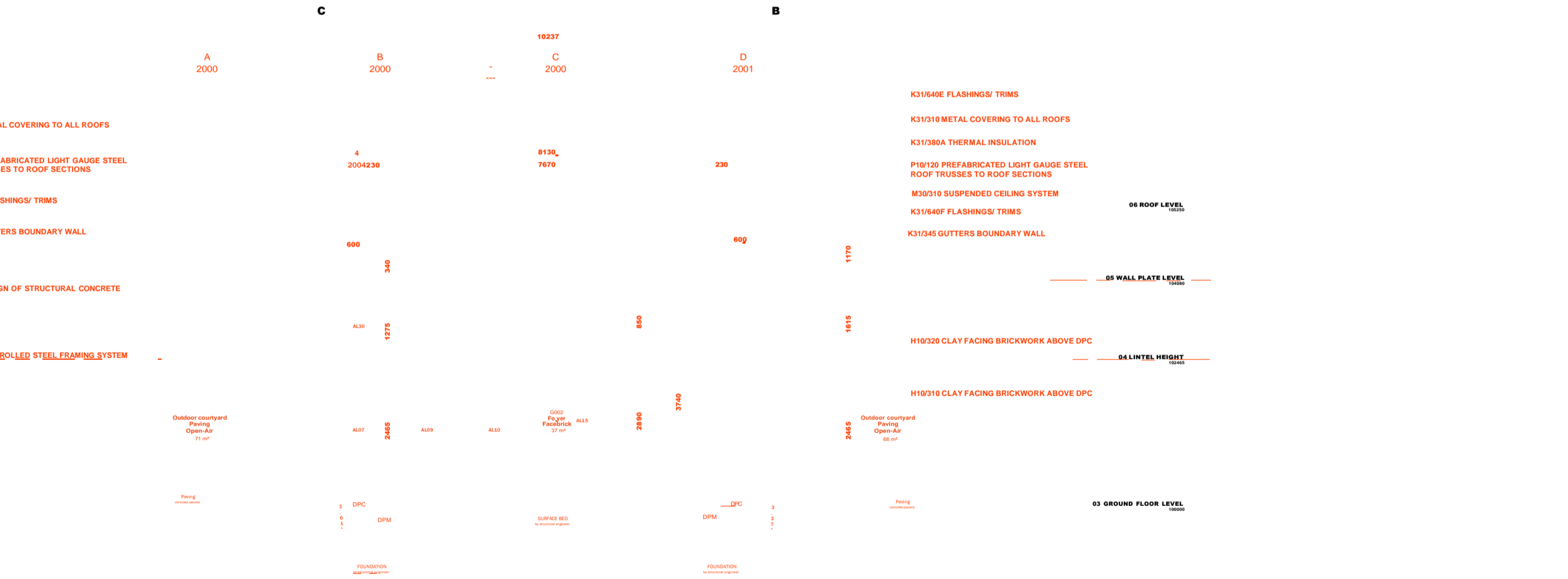

SECTION F-F
1:50

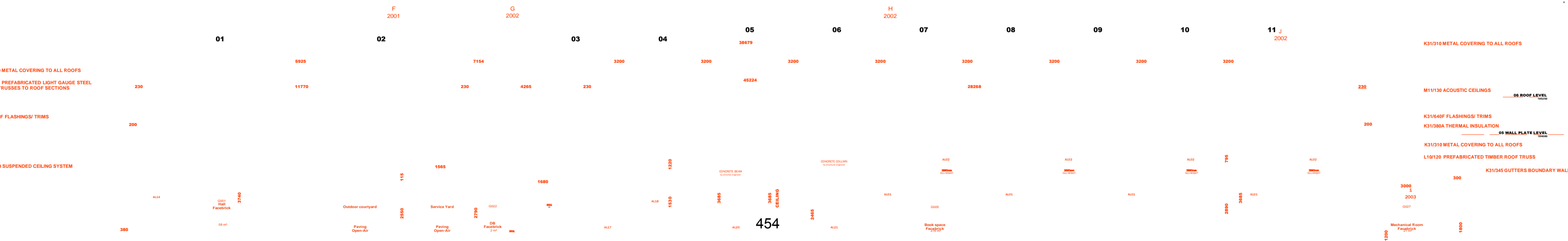

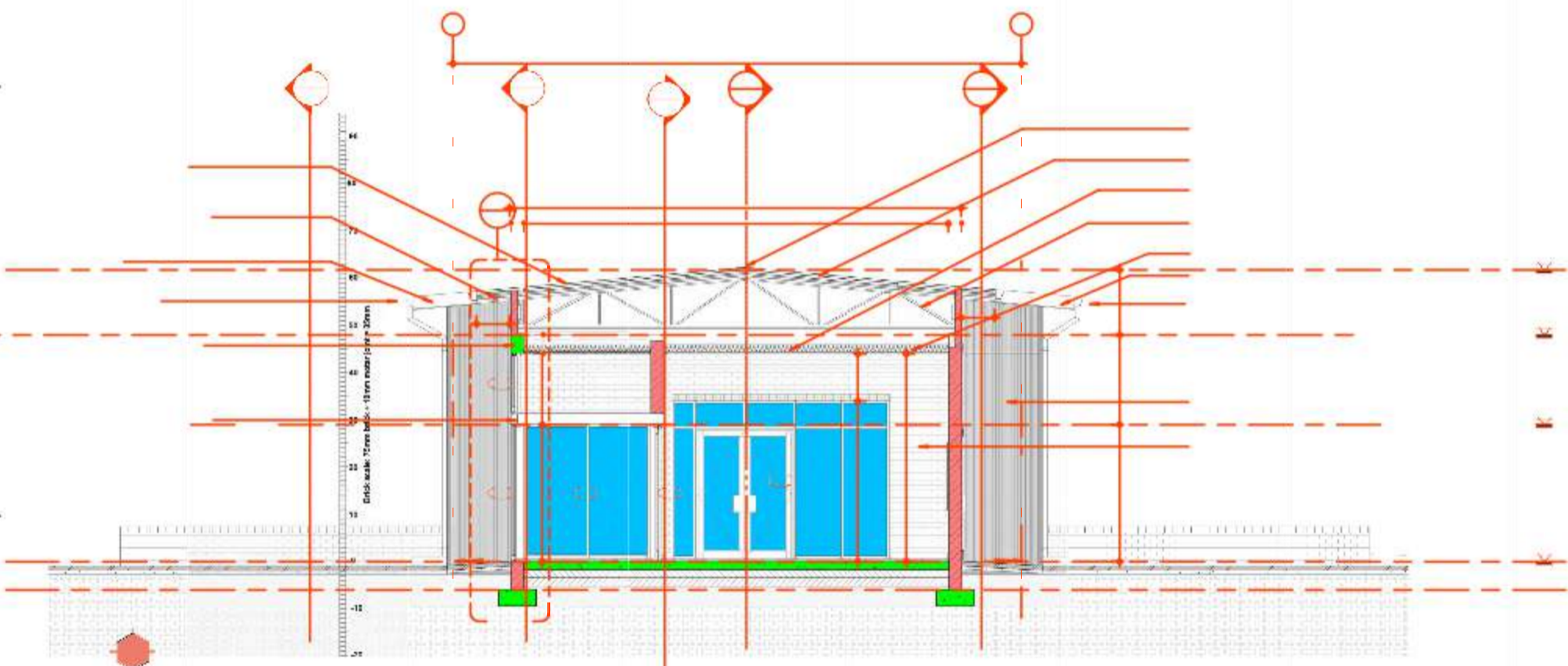
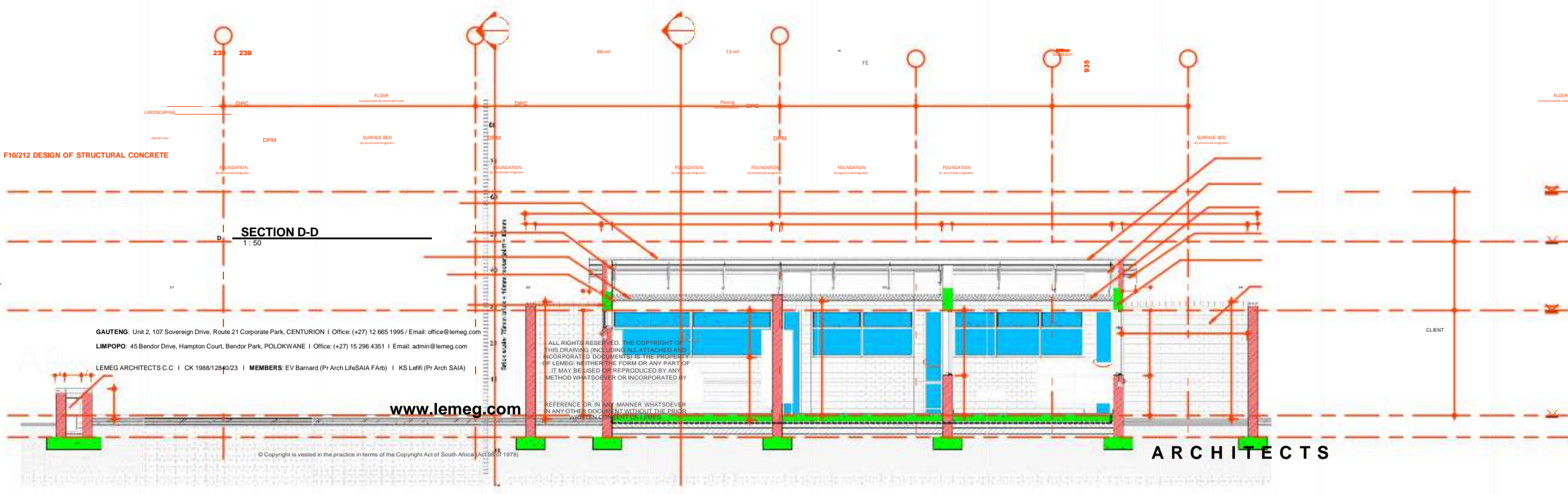

DISCLAIMER
 THE REQUIREMENT AND GUIDELINES SET OUT IN THIS DOCUMENT SHALL NOT APPLY OR BE IMPLEMENTED TO THE EXTENT THAT THEY DO NOT MEET THE REQUIREMENTS OF APPLICABLE LAWS AND REGULATIONS. IN ALL CASES, ALL APPLICABLE LEGAL AND REGULATORY REQUIREMENTS MUST BE MET WHEN CONDUCTING ACTIVITIES WITH THIS DOCUMENT.

CLIENT: Limpopo Department of Public Works, Roads & Infrastructure
 PROJECT NUMBER: 2101
 WORKSTAGE: W04
 DATE: 2021/10/22 09:12:34
 AUTHOR: THC
 PROJECT LEADER: AAB
 SACAP NUMBER:

PROJECT NAME: NEW LIBRARIES
 DRAWING NAME: BUILDING SECTIONS

PROJECT ADDRESS: VARIOUS SITES

DRAWING NUMBER: AE - 2 - 2001 - X00

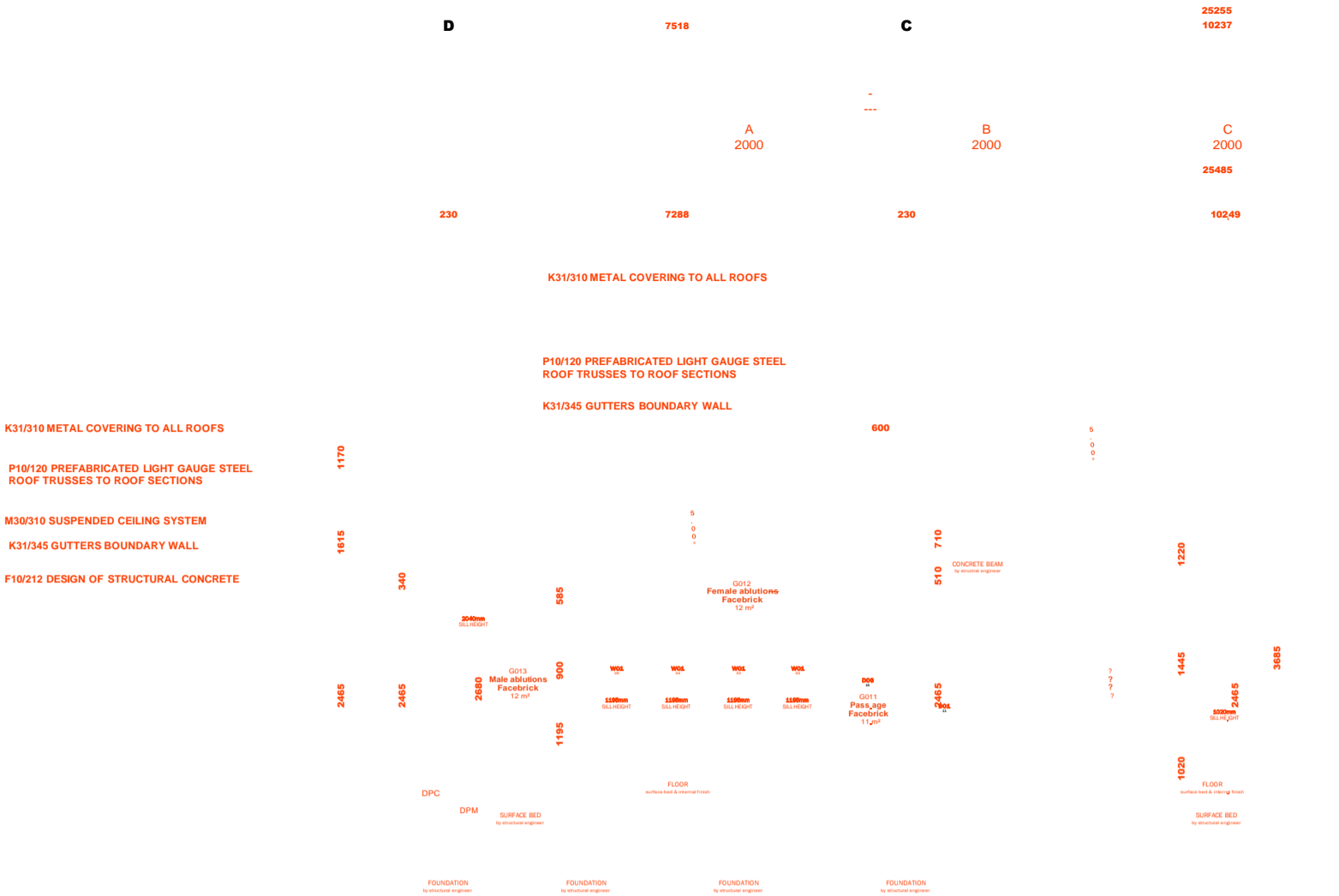

SECTION G-G
1:50

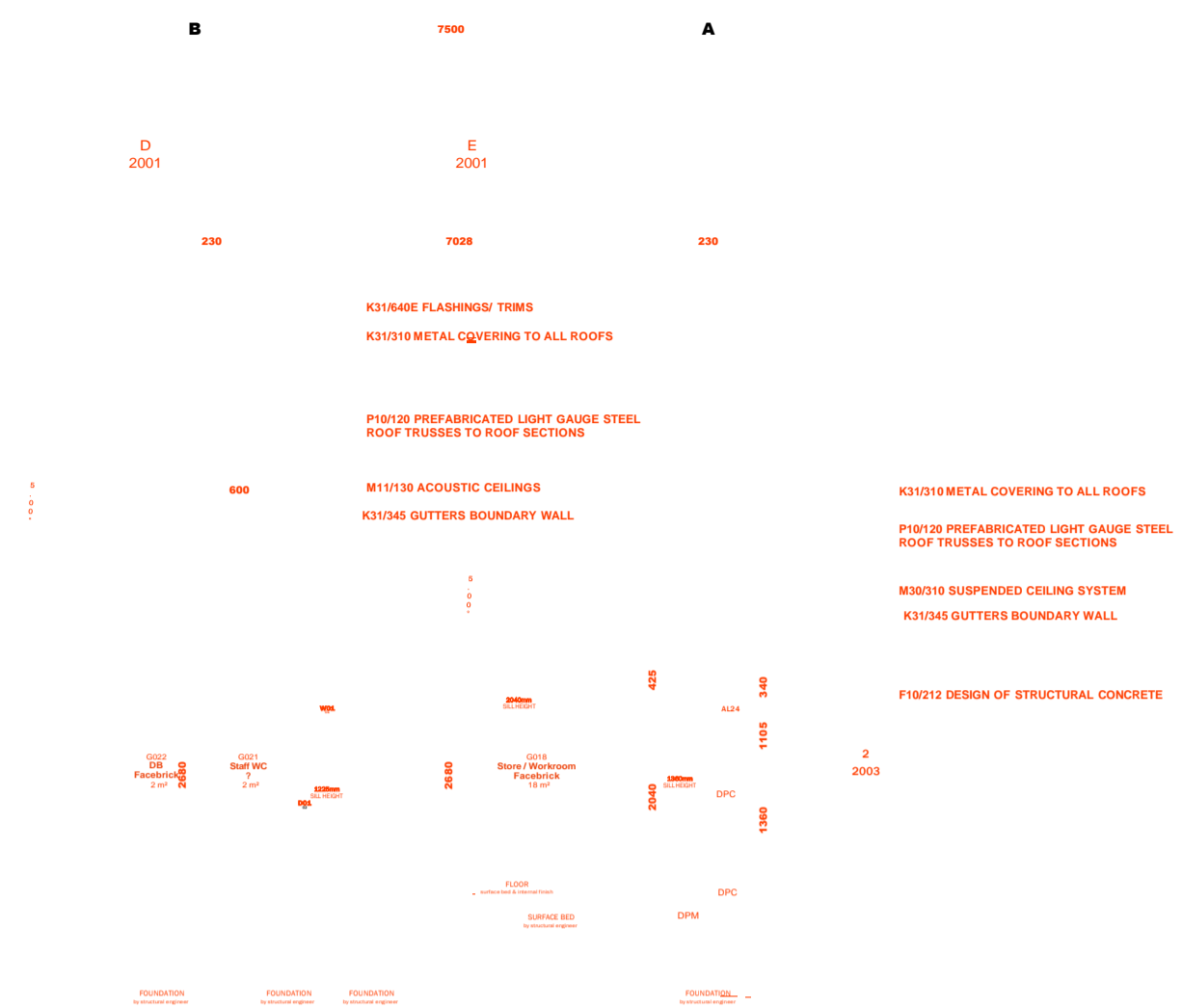

06 ROOF LEVEL
05 WALL PLATE LEVEL
04 LINTEL HEIGHT
03 GROUND FLOOR LEVEL

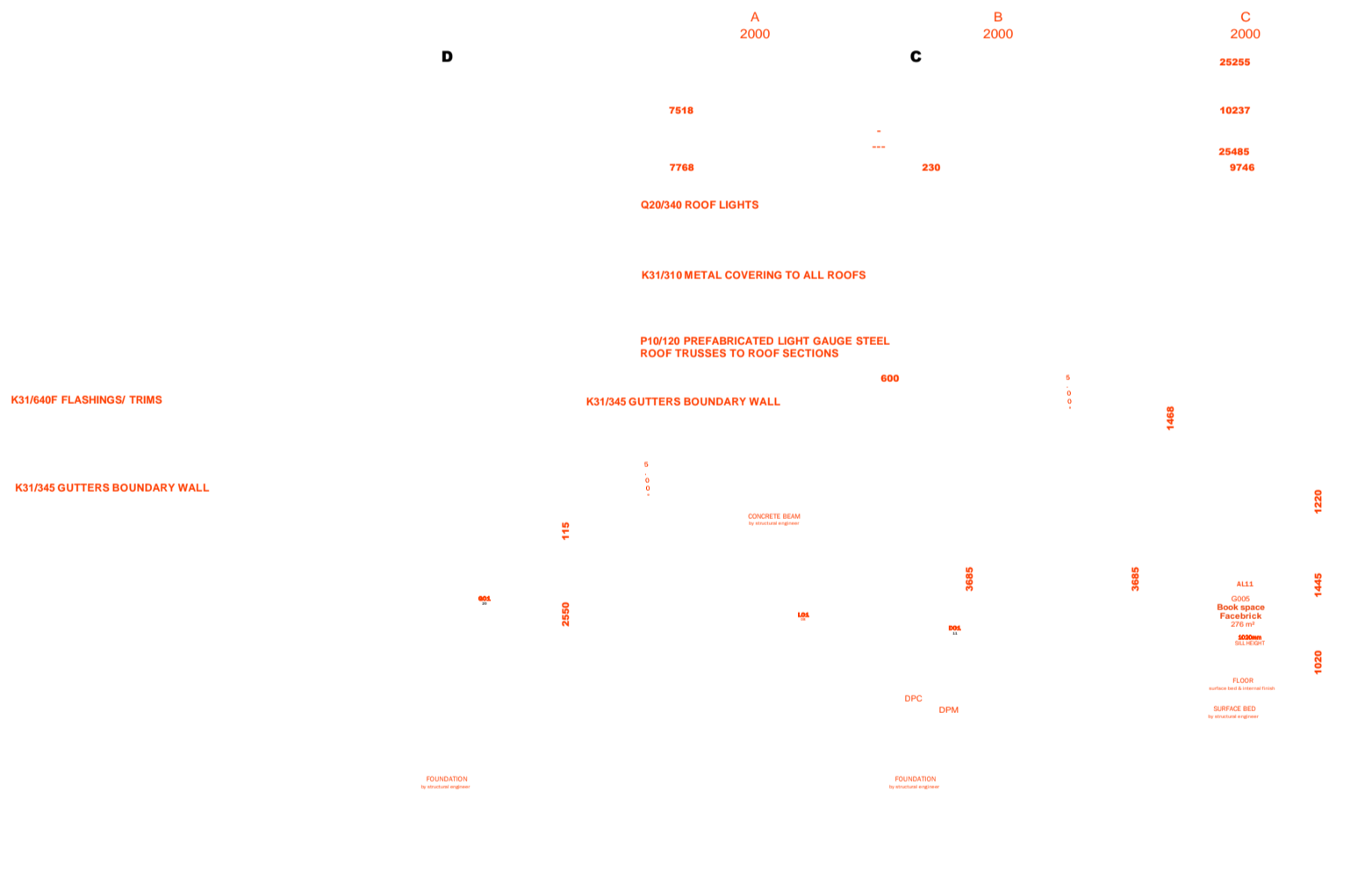

SECTION H-H
1:50

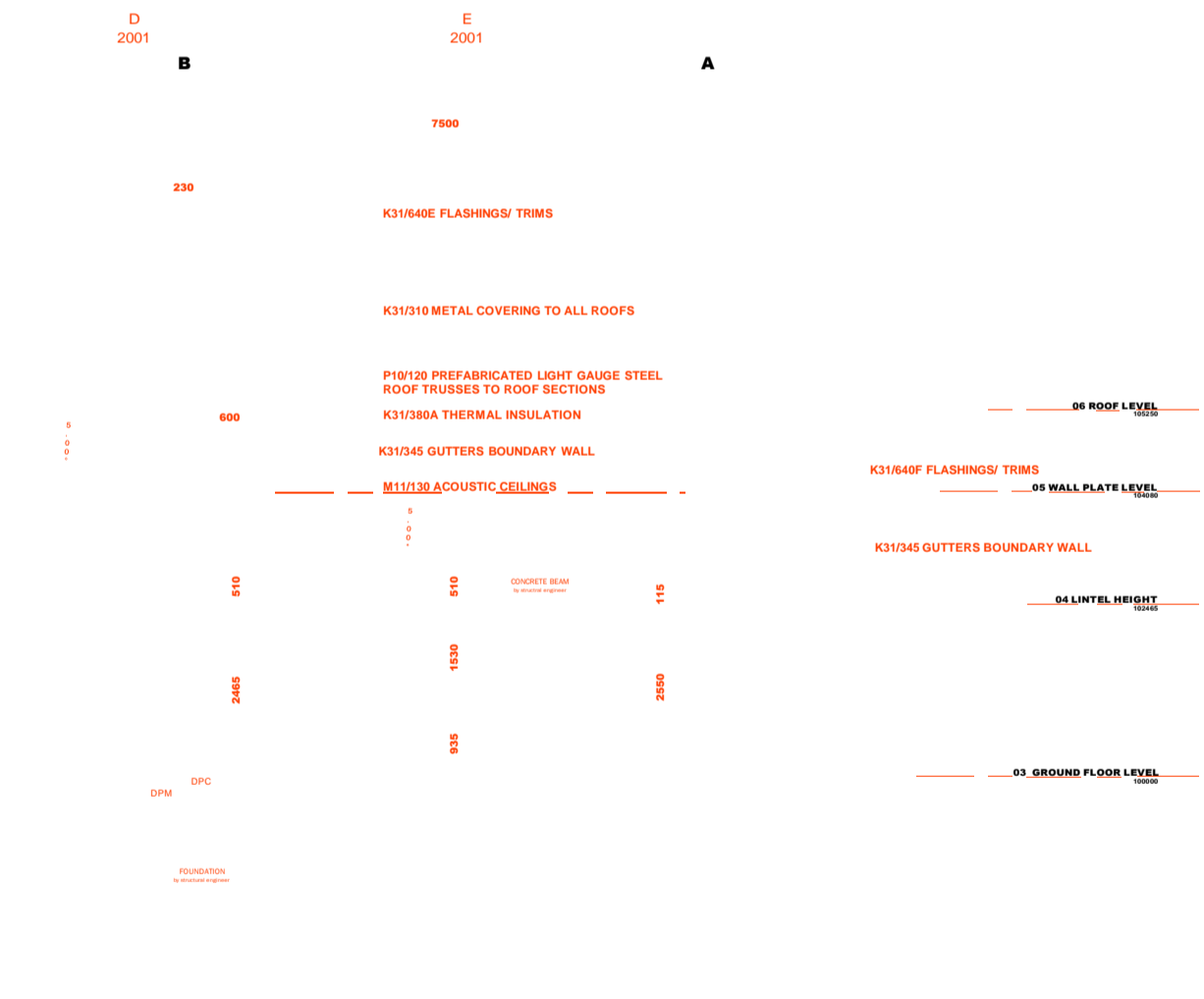

06 ROOF LEVEL
05 WALL PLATE LEVEL
04 LINTEL HEIGHT
03 GROUND FLOOR LEVEL

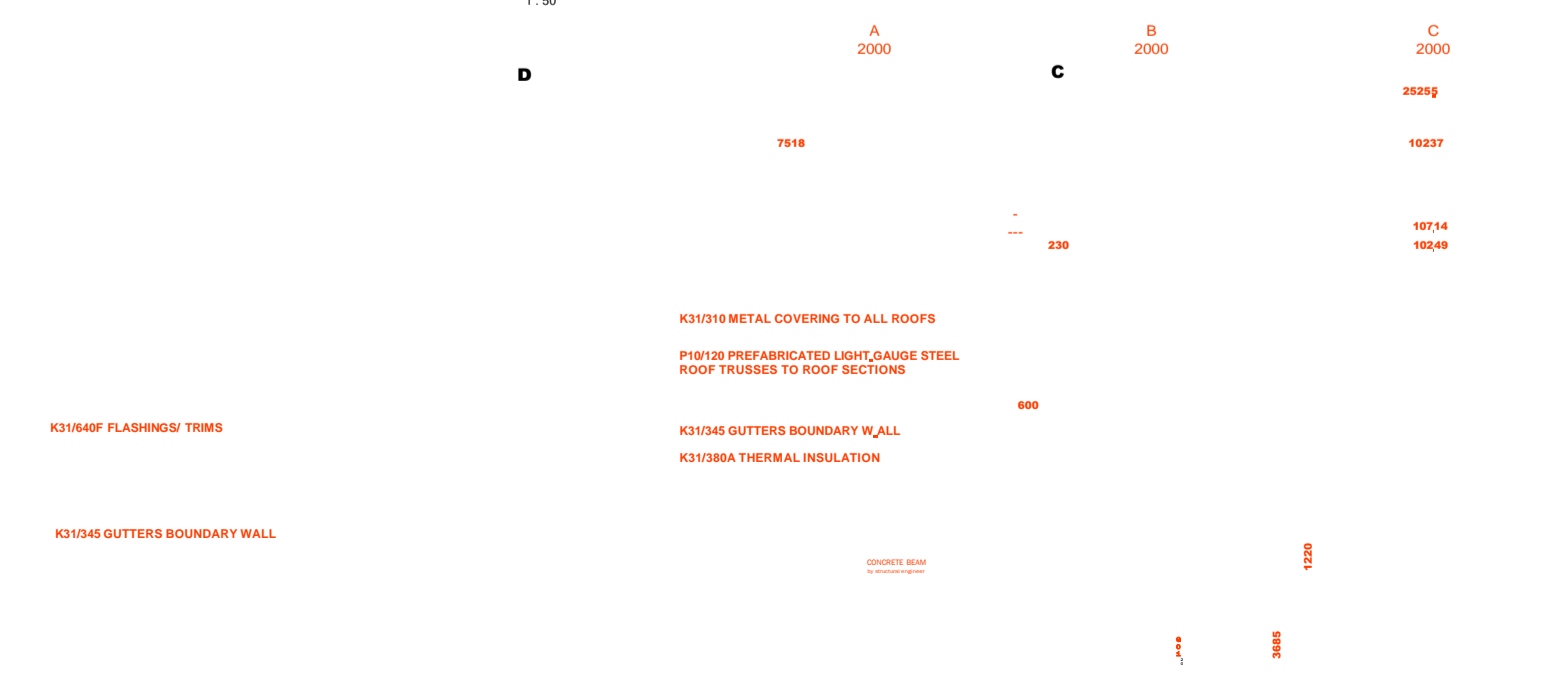

SECTION I-I
1:50

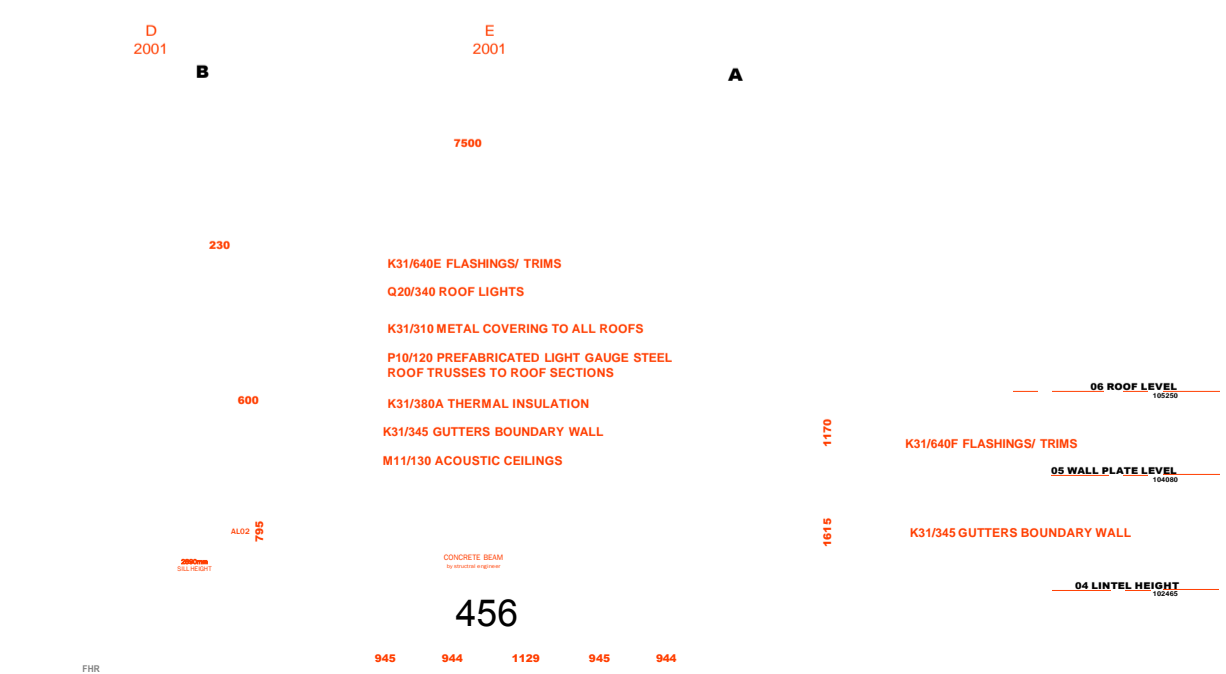

06 ROOF LEVEL
05 WALL PLATE LEVEL
04 LINTEL HEIGHT

Keynote Legend	
Key Value	Keynote Text
F10/212 DESIGN OF STRUCTURAL CONCRETE	Materials, drawings, specification, protective equipment and quality assurance must be according to the engineer
K31/310 METAL COVERING TO ALL ROOFS	Global Roofing Solutions (or similar approved) 0.58mm thick 700mm cover Kip-Tile™ profile Chromadek® Z200 spelter ISO550 Dark Dolphin finish top coat and Pebble Grey backing coat Galvanised steel roof sheeting, fixed to steel intermediate purlins at MAX 2500mm centres and eaves and ridge purlins at MAX 2100mm centres using KL700 plus clips fixed with 10No.16 x 16mm long self-drilling water head PH2 screws, No. 3 drill point fasteners, all in accordance with the manufacturer's specifications. • Brand: ArcelorMittal • Climatic Condition: inland - C1/C2 Low Corrosion Risk.
K31/345 GUTTERS BOUNDARY WALL	Profile Colorbond pre-coated Chromadek seamless gutter, size 150 x 125 x 0,5mm thick in colour Armour Grey including matching rivet-fixed mitres and end caps internally sealed using Silicon Mastic, hung by nail fixed internal aluminium hangers at 900mm centres with rectangular fluted downpipes, size 85mm Dia x 0,5mm thick in colour Armour Grey fixed to walls with pre-painted downpipe cleats using nail-in anchor fixings.
K31/380A THERMAL INSULATION	Install Isover 135mm thick Aerolite non-combustible light weight Glasswool thermal ceiling insulation. • R-value: 3,38m² K/W • Thermal conductivity: 0,04 W/m²K.
K31/640E FLASHINGS/ TRIMS	Global Roofing Solutions (or similar approved) 0,80mm thick Galvanised steel Z200 spelter ISO550 Chromadek® Dark Dolphin finish top coat and Pebble Grey backing coat Galvanised steel, girth 550mm ridge cap (Code: FK73), fixed in accordance with manufacturer's specifications. • Brand: ArcelorMittal • Climatic Condition: inland - C1/C2 Low Corrosion Risk
K31/640F FLASHINGS/ TRIMS	Global Roofing Solutions (or similar approved) 0,80mm thick Galvanised steel Z200 spelter ISO550 Chromadek® Charcoal Grey finish top coat and Pebble Grey backing coat Galvanised steel, girth 580mm barge (Code: FK713) fixed in accordance with manufacturer's specifications. • Brand: ArcelorMittal • Climatic Condition: inland - C1/C2 Low Corrosion Risk
M11/130 ACOUSTIC CEILINGS	OWAcoustic Constellation Premium biologically absorbable mineral wool ceiling tiles, NRC - 0,70, CAC - 33dB, Fire classification A2-s1, d0, weight - 4,5 kg/m², size 1200 x 600 x 15mm with Square-edge and white painted finish, laid on fire rated OWAcoustic S15 exposed demountable T15 suspension system, comprising galvanised main tees and cross tees with main tees suspended by means of galvanised hangers at centres not exceeding 1200mm, and all installed to manufacturer's instructions.
M30/310 SUSPENDED CEILING SYSTEM	Lay Gyproc Gyprex Fissured 1200mm x 600mm ceiling tile into the Donn ceiling grid. Ceiling grid consisting of Donn Wall Angle (SM25/M6) fixed to the perimeter wall using fixings at 300mm centres. Space Donn Main Tees T38 FR at 1200mm centres. Suspend main tees using Donn Pre-stretched Galvanised Hanger wire 2,5mm thick or Donn hanger strap 19mm at 1200mm centres. Donn Pre-stretched Galvanised Hanger wire shall be put through the main tees hole and would wind 3 times around itself. 2 steel pop-nuts or one Donn Water Head Tek screw 13mm shall be used to fix the hanger strap to the main tees web. Install Donn Cross Tees T38V/T32V (1200 long) at 600mm centres to create a 1200mm x 600mm ceiling grid. Main tee should be fixed to the wall using angle cleats. • Ceiling System: Gyproc Exposed Ceiling System Gyprex Fissured 1200 x 600mm • Ceiling Grid: exposed ceiling grid.
P10/120 PREFABRICATED LIGHT GAUGE STEEL ROOF TRUSSES TO ROOF SECTIONS	Materials, drawings, specification, protective equipment and quality assurance must be according to the engineer
Q20/340 ROOF LIGHTS	Global Roofing (or similar approved) Solutions Sungazer Standard 5mm thick perspex sun harvester, size 1000mm x 600mm, installed in accordance with manufacturer's recommendations. • Product: Sungazer Standard • Size: 1000mm x 600mm • Colour: clear with prismatic characteristics • Shape: pyramidal dome • Dome with Fresnell lensing: 5mm UV stabilised Perspex • Weight: 16kg per unit.

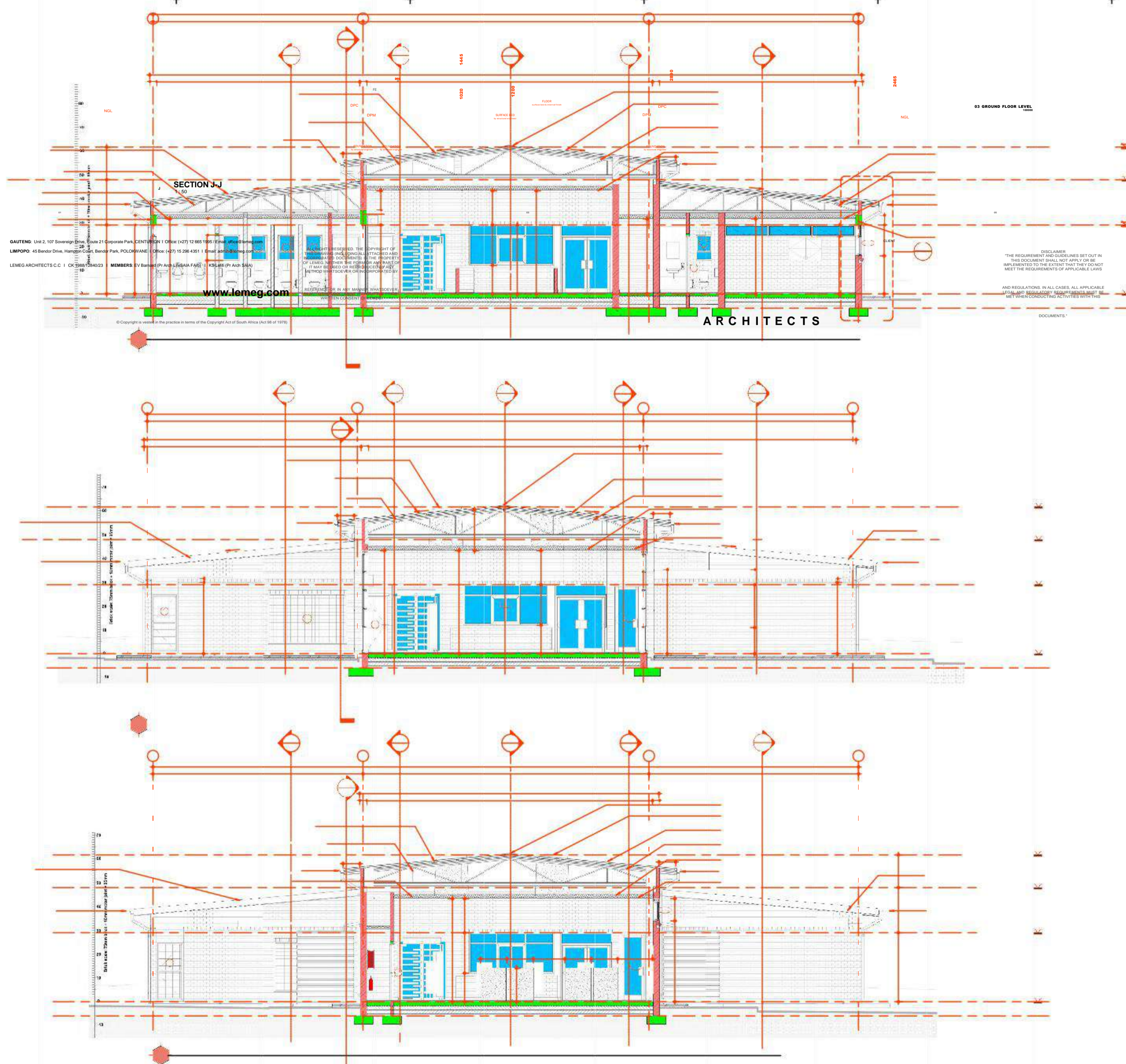

GAUTENG: Unit 2, 107 Sovereign Drive, Route 21 Corporate Park, CENTURION 1 Office: (+27) 12 665 1995 / E-mail: office@lemeg.com
 LIMPOPO: 45 Bendor Drive, Hampton Court, Bendor Park, POLOKWANE Office: (+27) 15 296 4351 | E-mail: admin@lemeg.com
 LEMEG ARCHITECTS CC | CK 2007/04023 MEMBERS: EV Bantwini (P/Arch), LINDA FAYE | KSLIBO (P/Arch SAQA)

www.lemeg.com

ARCHITECTS RESERVE THE COPYRIGHT OF THESE AND ALL RELATED DOCUMENTS. THE PROPERTY OF LEMEG ARCHITECTS. THE FORMS AND VALUE OF IT MAY BE REPRODUCED OR REPRODUCED BY ANY METHOD WITHOUT THE WRITTEN CONSENT OF LEMEG ARCHITECTS.

DISCLAIMER
 "THE REQUIREMENTS AND GUIDELINES SET OUT IN THIS DOCUMENT SHALL NOT APPLY OR BE IMPLEMENTED TO THE EXTENT THAT THEY DO NOT MEET THE REQUIREMENTS OF APPLICABLE LAWS AND REGULATIONS. IN ALL CASES, ALL APPLICABLE LAWS AND REGULATIONS MUST BE MET WHEN CONDUCTING ACTIVITIES WITH THIS DOCUMENT."

ARCHITECTS

CLIENT: Limpopo Department of Public Works, Roads & Infrastructure
 PROJECT NUMBER: 2101
 WORKSTAGE: W04
 DATE: 2021/09/01 17:05:45
 AUTHOR: THC PROJECT LEADER: AAB SACAP NUMBER:

PROJECT NAME: NEW LIBRARIES
 DRAWING NAME: BUILDING SECTIONS
 PROJECT ADDRESS: VARIOUS SITES

DRAWING NUMBER: AE - 2 - 2002 - X00

REVISION SCHEDULE			
Number	Description	Date	Revised to

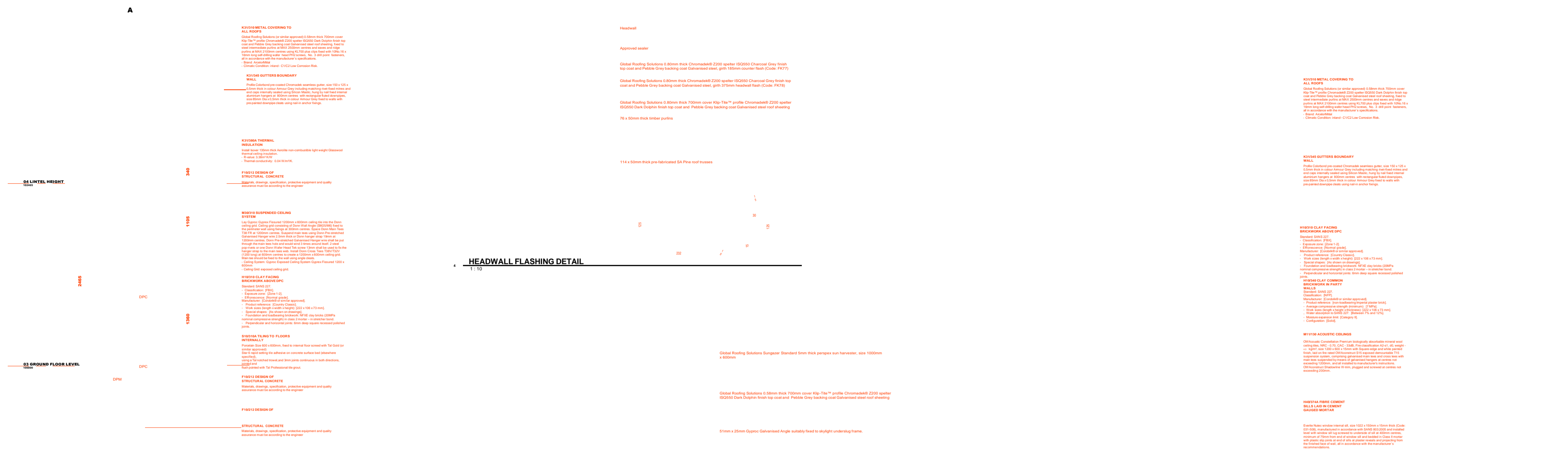

SECTION G-G - Callout 1
1:20

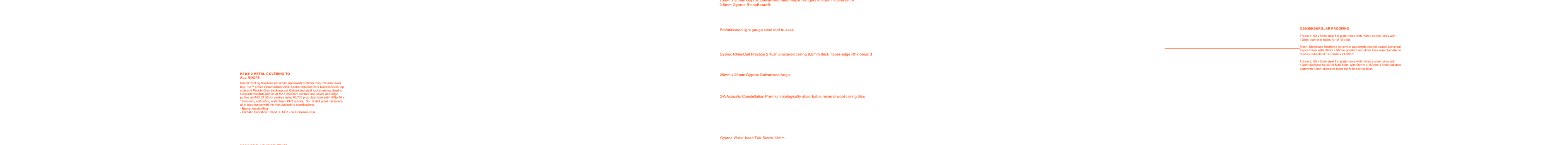

HEADWALL FLASHING DETAIL
1:10

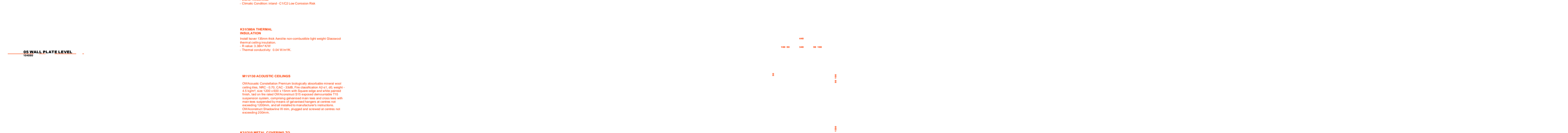

LIGHTWELL BULKHEAD DETAIL
1:20

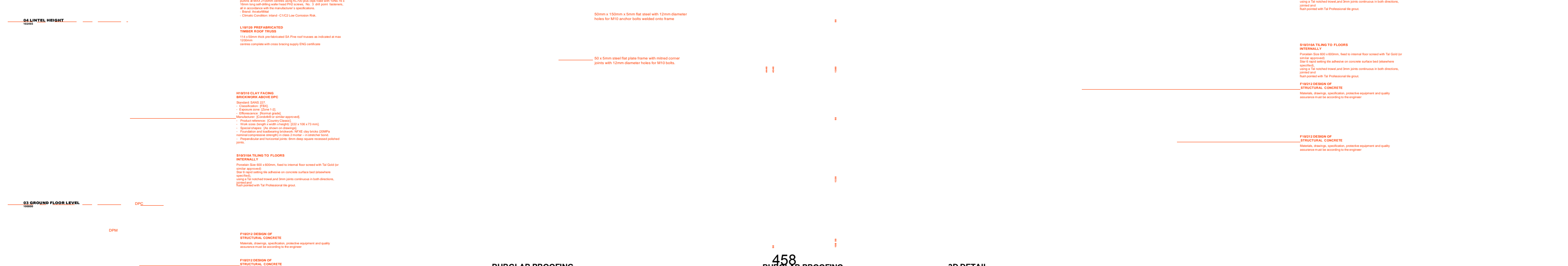

BURGLAR PROOFING
1:20

SECTION D-D - Callout 1

1:20

GAUTENG: Unit 2, 107 Sovereign Drive, Rose 21 Corporate Park, CENTURION | Office: (+27) 12 665 1995 / Email: office@lemeg.com
LIMPOPO: 45 Bendor Drive, Hampton Court, Bendor Park, POLKOWANE | Office: (+27) 15 294 4351 | Email: admin@lemeg.com
LEMEG ARCHITECTS CC - CK 4942129/23 - MEMBERS: E.V. Barnard (P/Arch LMSAA FArch) | KS Luff (P/Arch SAIA)

www.lemeg.com

ALL RIGHTS RESERVED. THE COPYRIGHT OF THIS DRAWING (INCLUDING ALL ATTACHED AND INCORPORATED DOCUMENTS) IS THE PROPERTY OF LEMEG. NEITHER THE FORM OR ANY PART OF IT MAY BE USED OR REPRODUCED BY ANY METHOD WHATSOEVER OR INCORPORATED BY REFERENCE OR IN ANY MANNER WHATSOEVER IN ANY OTHER DOCUMENT WITHOUT THE PRIOR WRITTEN CONSENT OF LEMEG.

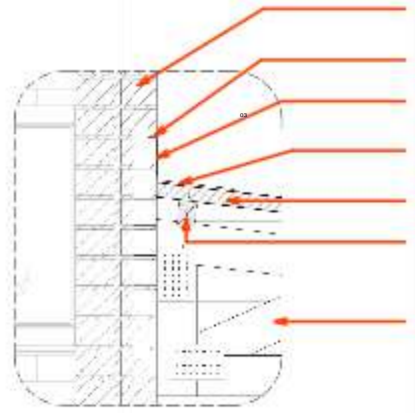

ARCHITECTS

CLIENT

CLIENT Limpopo Department of Public Works, Roads & Infrastructure

PROJECT NUMBER 2101

PROJECT NAME NEW LIBRARIES

DRAWING NAME PERIMETER SECTIONS & DETAILS

WORKSTAGE W04

DRAWING SCALE As indicated

DATE 2021/09/01 17:07:58

DESIGNER JB + THC

PROJECT LEADER AAB

SACAP NUMBER

PROJECT ADDRESS VARIOUS SITES

TENDER/PROCUREMENT

REVISION

DRAWING NUMBER AE - 2 - 2003 - X00

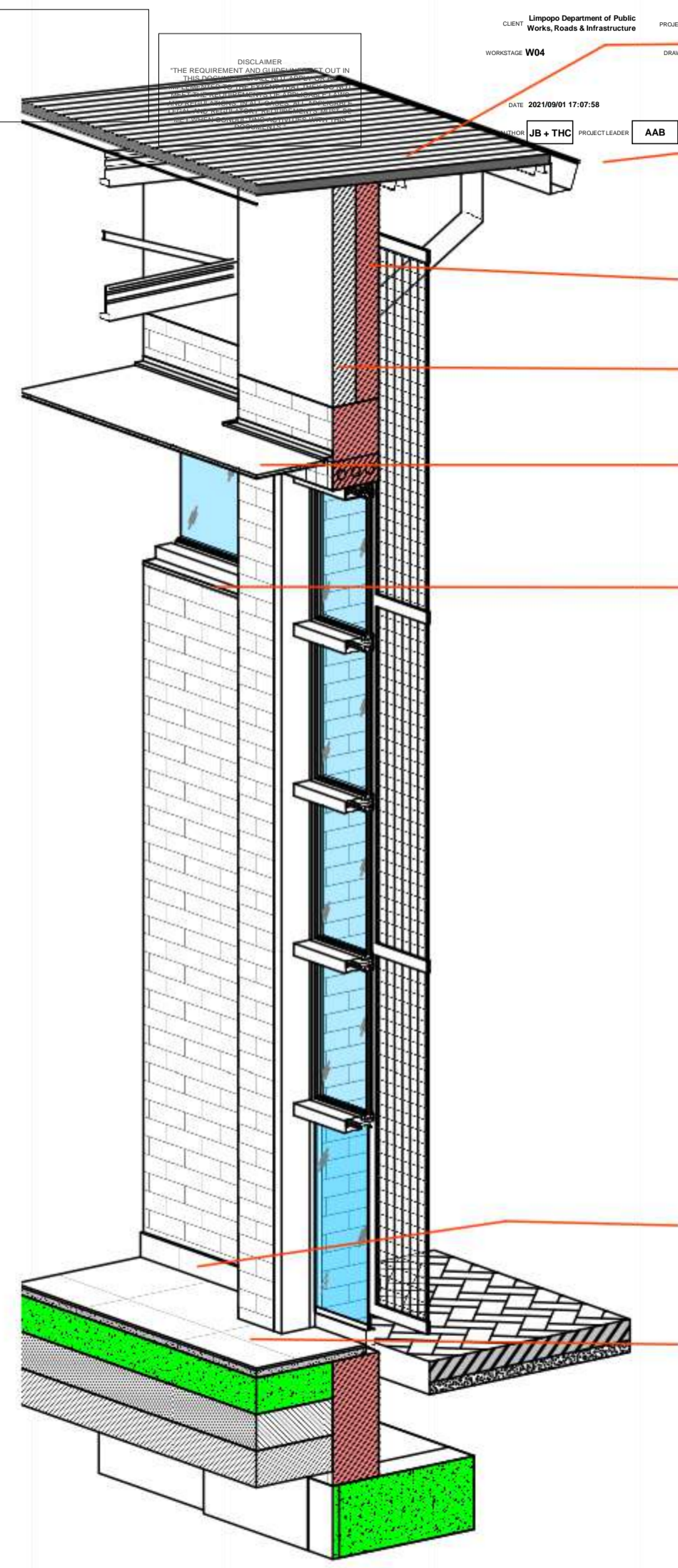
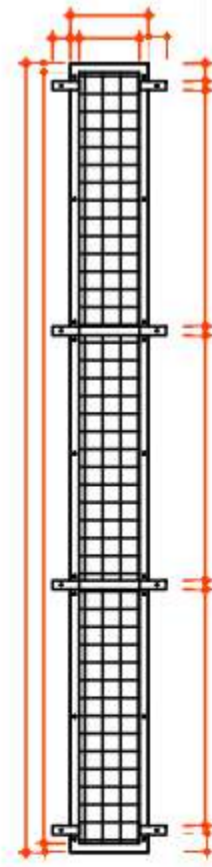
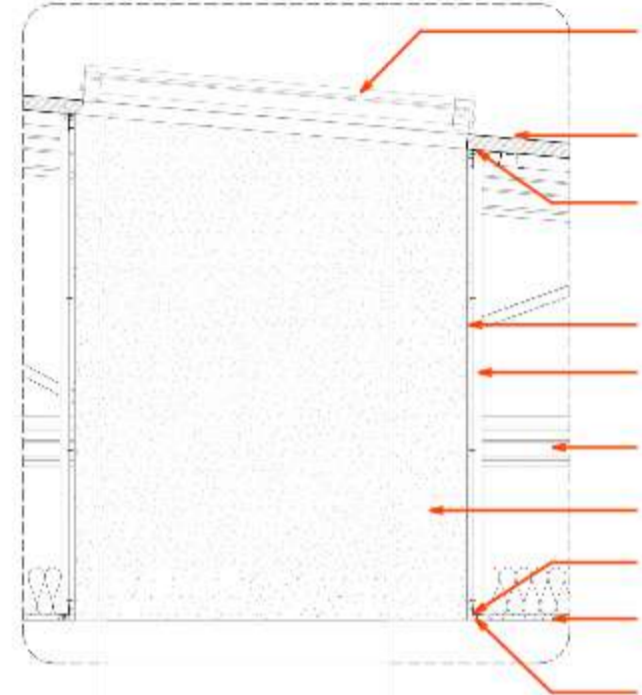
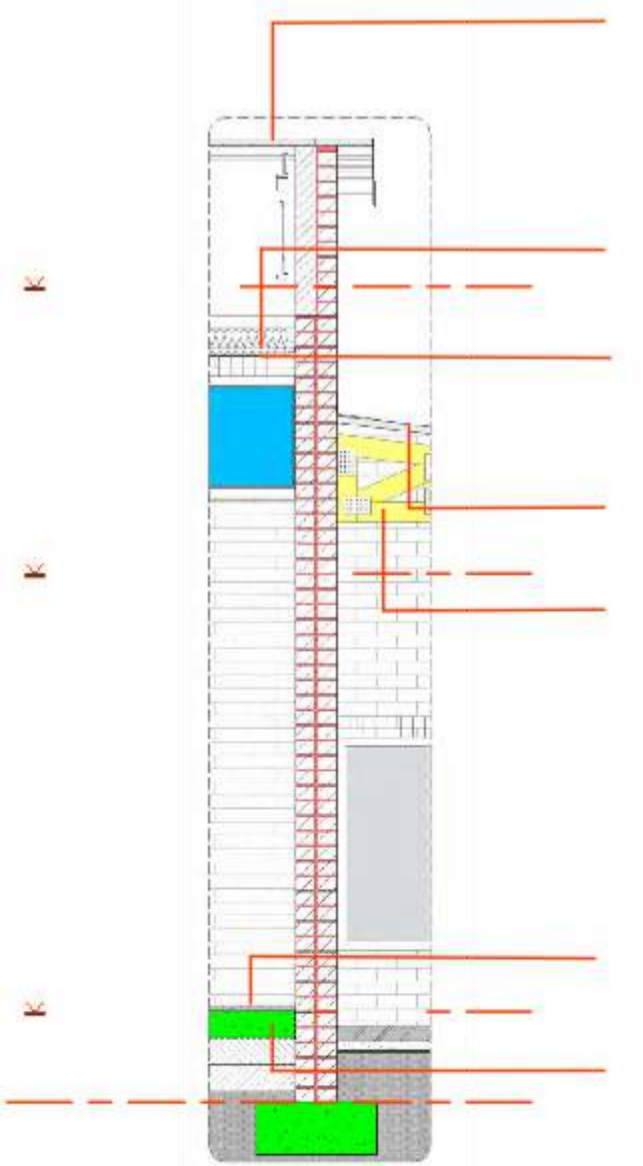
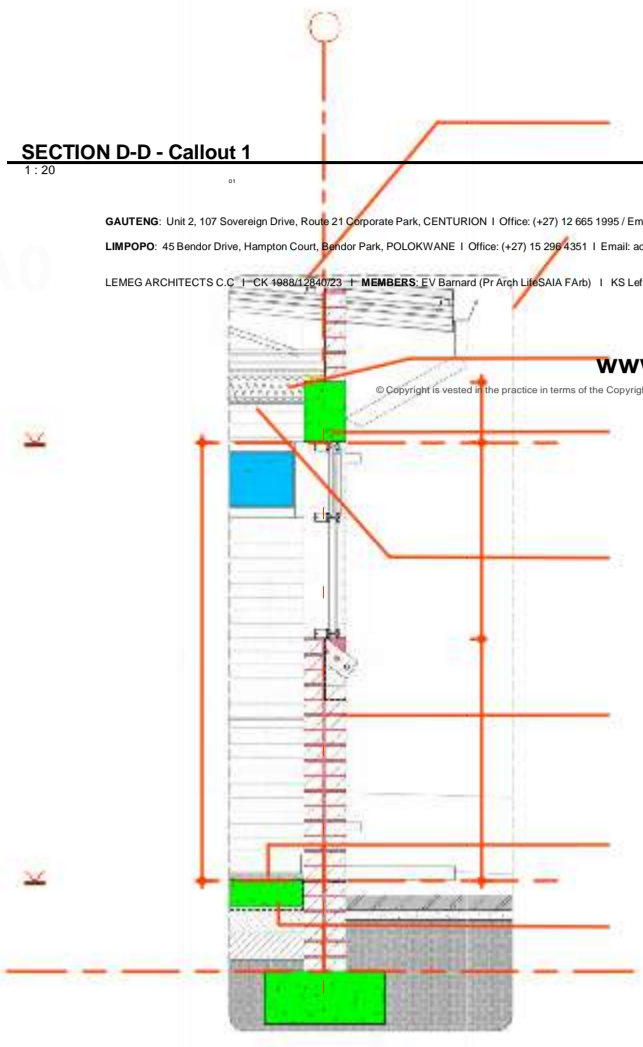

REVISION SCHEDULE

Table with 4 columns: Number, Description, Date, Revised to

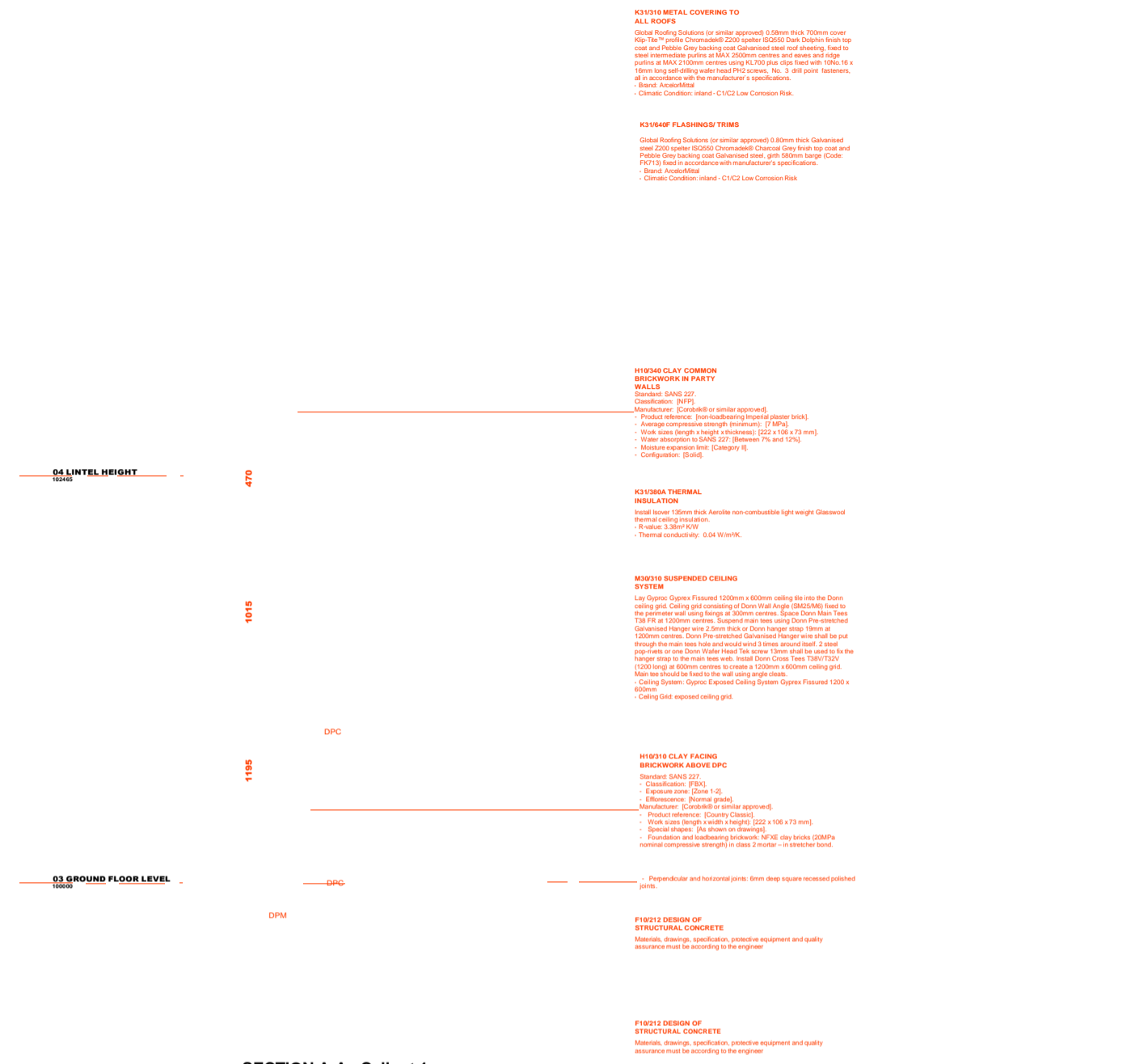

SECTION A-A - Callout 1



SECTION F-F - Callout

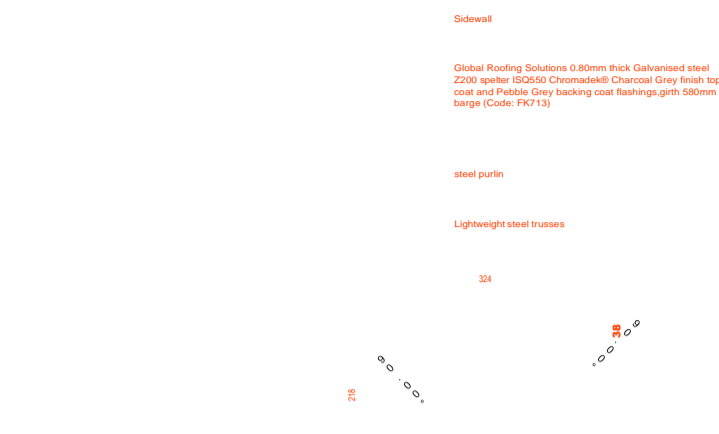

BARGE FLASHING DETAIL



RIDGE CAP FLASHING

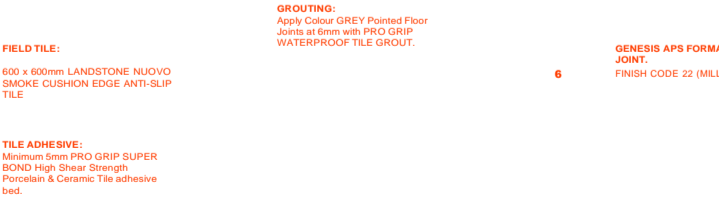

TYPICAL TILE MOVEMENT JOINT

K1010 METAL COVERING TO ALL ROOFS
Global Roofing Solutions (or similar approved) 0.80mm thick 700mm cover Rip-Tite™ profile Chromadek® Z200 spher...

K1010 METAL COVERING TO ALL ROOFS
Global Roofing Solutions (or similar approved) 0.80mm thick 700mm cover Rip-Tite™ profile Chromadek® Z200 spher...

K1010 METAL COVERING TO ALL ROOFS
Global Roofing Solutions (or similar approved) 0.80mm thick 700mm cover Rip-Tite™ profile Chromadek® Z200 spher...

F1010 PREFABRICATED LIGHT GAUGE STEEL ROOF TRUSSES TO ROOF SECTIONS
Materials, drawings, specification, protective equipment and quality assurance must be according to the engineer

M1010 SUSPENDED CEILING SYSTEM
Lay Gyproc Gyproc Plastered 1200mm x 600mm ceiling tile into the Down ceiling grid...

M1010 PERIMETER TRIMS AROUND ALL SUSPENDED CEILING SPACES
Down-board perimeter wall angle perimeter trim fixed to wall using fixings at 200mm centres.

F1010 DESIGN OF STRUCTURAL CONCRETE
Materials, drawings, specification, protective equipment and quality assurance must be according to the engineer

F1010 HOT ROLLED STEEL FRAMING SYSTEM
Materials, drawings, specification, protective equipment and quality assurance must be according to the engineer

F1010 DESIGN OF STRUCTURAL CONCRETE
Materials, drawings, specification, protective equipment and quality assurance must be according to the engineer

S1010A TILING TO FLOORS INTERNALLY
Provide Size 600 x 600mm, fixed to internal floor screed with Tile Grid (or similar approved)...

L1010 ENTRANCE MATTING
Use as stipulated with recess frame AMP10101, fixed to metal skirting...

F1010 DESIGN OF STRUCTURAL CONCRETE
Materials, drawings, specification, protective equipment and quality assurance must be according to the engineer

H1010 HORIZONTAL DPC
Chamberl AF1 (or similar approved) Base SABS 375 (the embossed plastic in use must conform to SABS 375:2011) installed in solid accordance with manufacturer's specification.

3D DETAIL - SECTION F-F

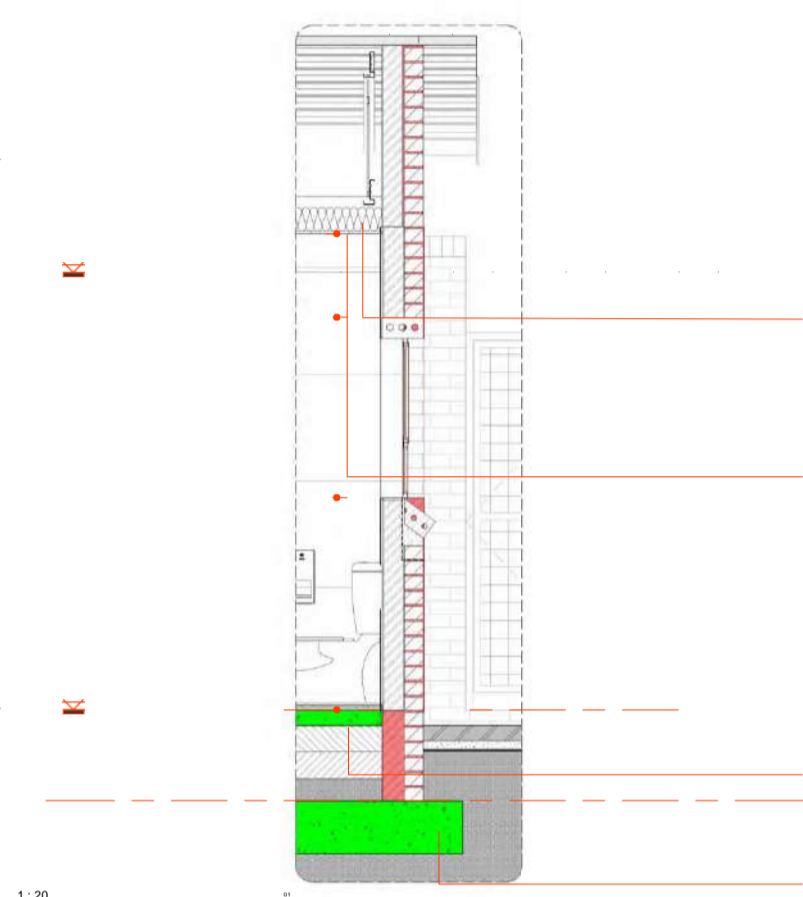

GAUTENG: Unit 2, 107 Sovereign Drive, Route 21 Corporate Park, CENTURION | Office: (+27) 12 665 1955 / Email: office@lemeg.com
 LIMPOPO: 45 Bendor Drive, Hampton Court, Bendor Park, POLKOWANE | Office: (+27) 15 296 4351 | Email: admin@lemeg.com
 LEMEG ARCHITECTS CC | CK 1988/12840/23 | MEMBERS: Ev Barnard (Pr Arch LifeSAIA FAes) | KS Luffi (Pr Arch SAIA)

www.lemeg.com
 © Copyright is vested in the practice in terms of the Copyright Act of South Africa (Act 98 of 1978).

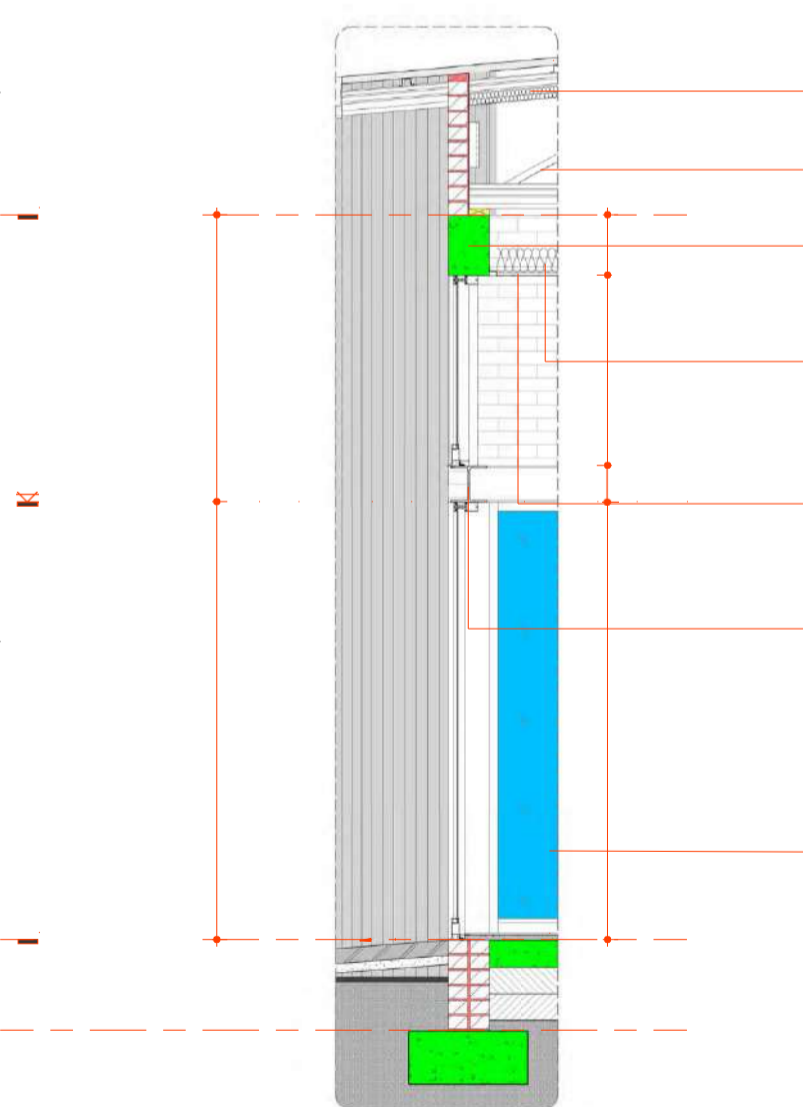

ALL RIGHTS RESERVED. THE COPYRIGHT OF THIS DRAWING (INCLUDING ALL ATTACHED AND INCORPORATED DOCUMENTS) IS THE PROPERTY OF LEMEG. NEITHER THE FORM OR ANY PART OF IT MAY BE USED OR REPRODUCED BY ANY METHOD WHATSOEVER OR INCORPORATED BY REFERENCE OR IN ANY MANNER WHATSOEVER IN ANY OTHER DOCUMENT WITHOUT THE PRIOR WRITTEN CONSENT OF LEMEG.

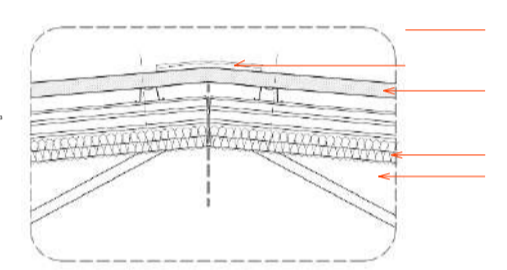
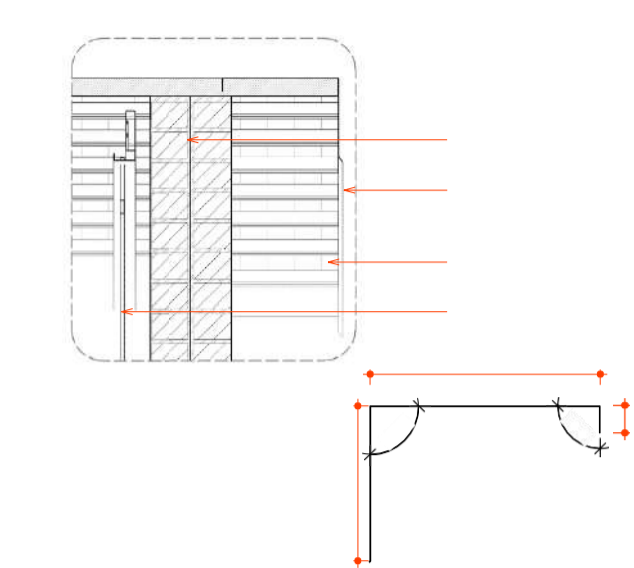

ARCHITECTS

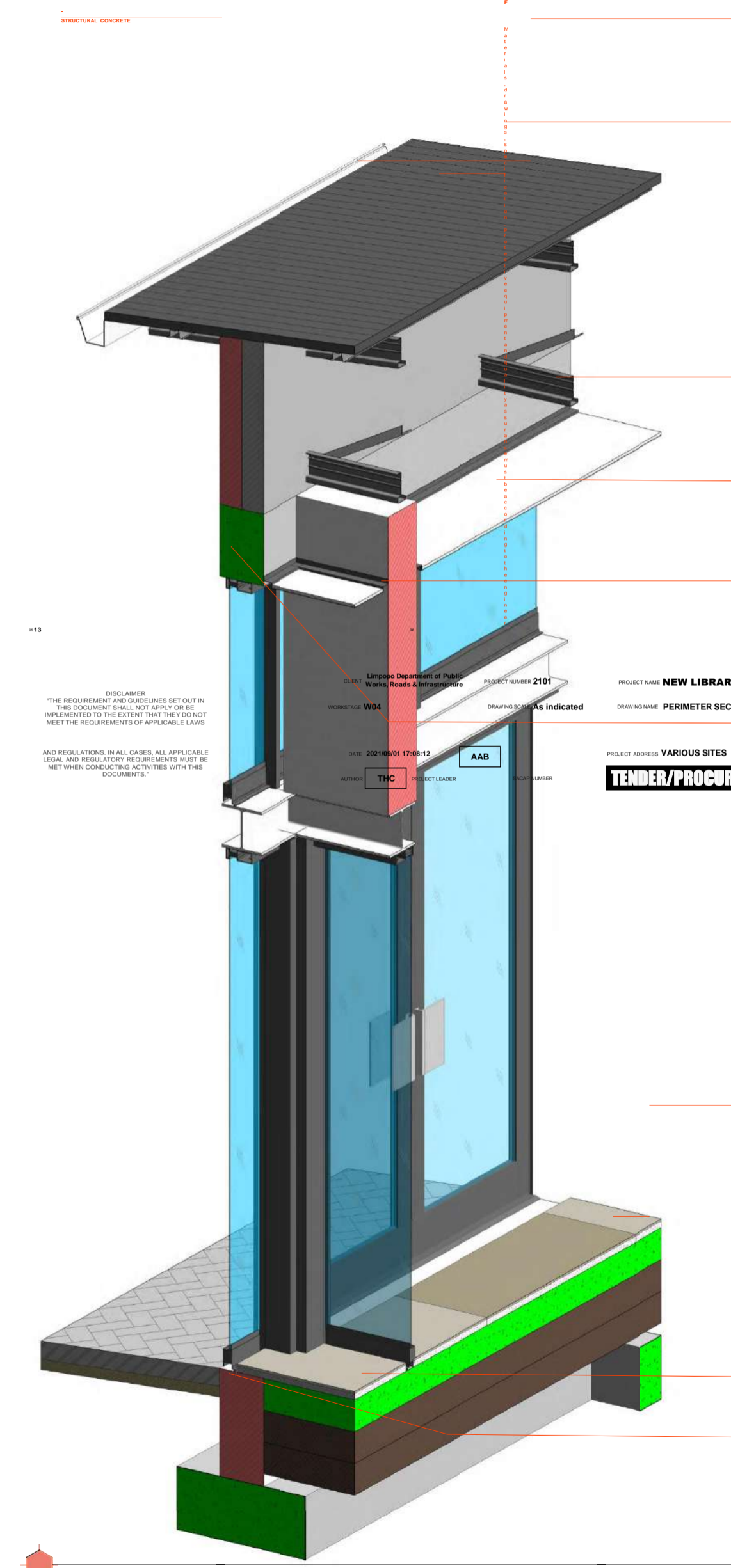
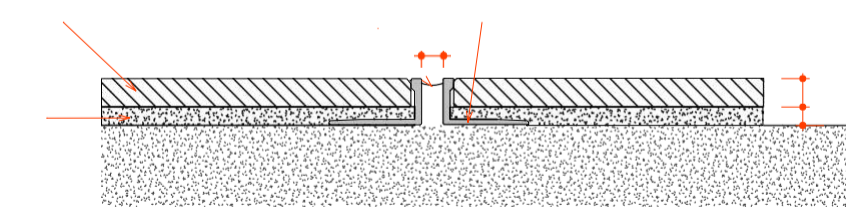

CLIENT: Limpopo Department of Public Works, Roads & Infrastructure
 PROJECT NUMBER: 2101
 WORKSTAGE: W04
 DATE: 2021/09/01 17:00:12
 AUTHOR: THC
 PROJECT LEADER: AAB

DISCLAIMER
 "THE REQUIREMENT AND GUIDELINES SET OUT IN THIS DOCUMENT SHALL NOT APPLY OR BE IMPLEMENTED TO THE EXTENT THAT THEY DO NOT MEET THE REQUIREMENTS OF APPLICABLE LAWS AND REGULATIONS. IN ALL CASES, ALL APPLICABLE LEGAL AND REGULATORY REQUIREMENTS MUST BE MET WHEN CONDUCTING ACTIVITIES WITH THIS DOCUMENTS."

PROJECT NAME: NEW LIBRARIES
 DRAWING NAME: PERIMETER SECTIONS & DETAILS
 PROJECT ADDRESS: VARIOUS SITES

REVISION
 DRAWING NUMBER: AE - 2 - 2004 - X00

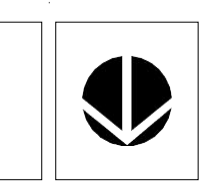

REVISION SCHEDULE			
Number	Description	Date	Issued To

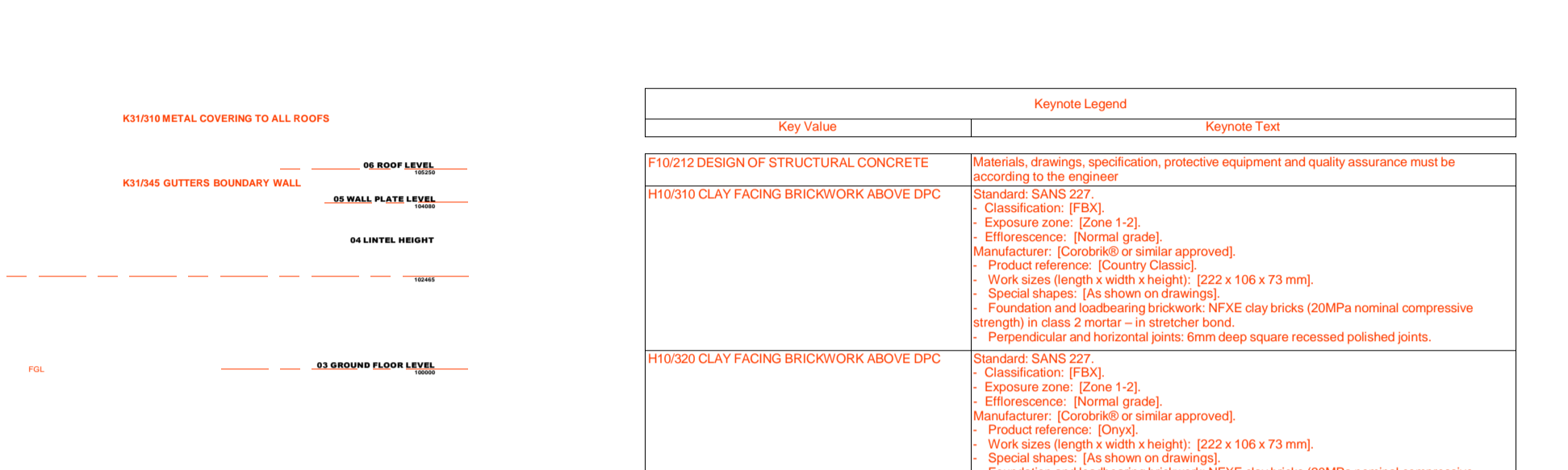
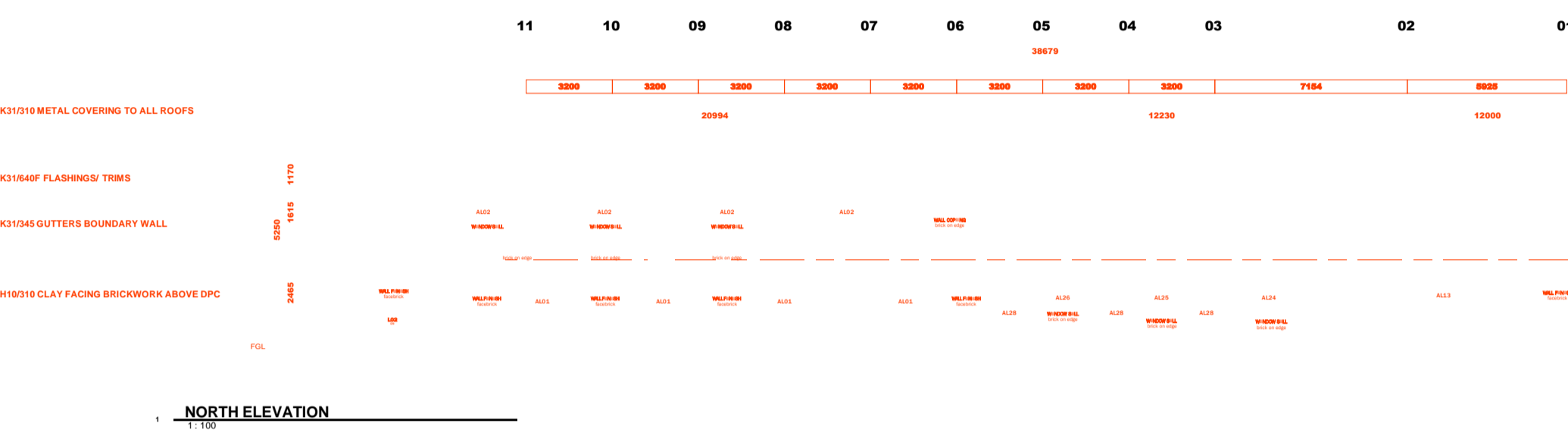

Keynote Legend	
Key Value	Keynote Text
F10/212 DESIGN OF STRUCTURAL CONCRETE	Materials, drawings, specification, protective equipment and quality assurance must be according to the engineer
H10/310 CLAY FACING BRICKWORK ABOVE DPC	Standard: SANS 227. - Classification: [FBX]. - Exposure zone: [Zone 1-2]. - Efflorescence: [Normal grade]. Manufacturer: [Corobrik® or similar approved]. - Product reference: [Country Classic]. - Work sizes (length x width x height): [222 x 106 x 73 mm]. - Special shapes: [As shown on drawings]. - Foundation and loadbearing brickwork: NFXE clay bricks (20MPa nominal compressive strength) in class 2 mortar – in stretcher bond. - Perpendicular and horizontal joints: 6mm deep square recessed polished joints.
H10/320 CLAY FACING BRICKWORK ABOVE DPC	Standard: SANS 227. - Classification: [FBX]. - Exposure zone: [Zone 1-2]. - Efflorescence: [Normal grade]. Manufacturer: [Corobrik® or similar approved]. - Product reference: [Ornyx]. - Work sizes (length x width x height): [222 x 106 x 73 mm]. - Special shapes: [As shown on drawings]. - Foundation and loadbearing brickwork: NFXE clay bricks (20MPa nominal compressive strength) in class 2 mortar – in soldier bond. - Perpendicular and horizontal joints: 6mm deep square recessed polished joints.
K31/310 METAL COVERING TO ALL ROOFS	Global Roofing Solutions (or similar approved) 0.58mm thick 700mm cover Kip-Tite™ profile Chromadek® Z200 spelter (ISO2550 Dark Dolphin finish top coat and Pebble Grey backing coat Galvanised steel roof sheeting, fixed to steel intermediate purlins at MAX 2500mm centres and eaves and ridge purlins at MAX 2100mm centres using KL700 plus clips fixed with 10No.16 x 16mm long self-drilling water head PH2 screws, No. 3 drill point fasteners, all in accordance with the manufacturer's specifications. • Brand: ArcelorMittal • Climatic Condition: inland - C1/C2 Low Corrosion Risk
K31/345 GUTTERS BOUNDARY WALL	Profile Colorbond pre-coated Chromadek seamless gutter, size 150 x 125 x 0.5mm thick in colour Armour Grey including matching rivet-fixed mitres and end caps internally sealed using Silicon Mastic, hung by nail fixed internal aluminium hangers at 800mm centres with rectangular fluted downpipes, size 85mm Dia x 0.5mm thick in colour Armour Grey fixed to walls with pre-painted downpipe cleats using nail-in anchor fixings.
K31/640F FLASHINGS/ TRIMS	Global Roofing Solutions (or similar approved) 0.80mm thick Galvanised steel Z200 spelter (ISO2550 Chromadek® Charcoal Grey finish top coat and Pebble Grey backing coat Galvanised steel, girth 580mm barge (Code: FK713) fixed in accordance with manufacturer's specifications. • Brand: ArcelorMittal • Climatic Condition: inland - C1/C2 Low Corrosion Risk
O10/110 SIGNAGE SYSTEM FOR DIRECTORY	Custom design to detail drawings

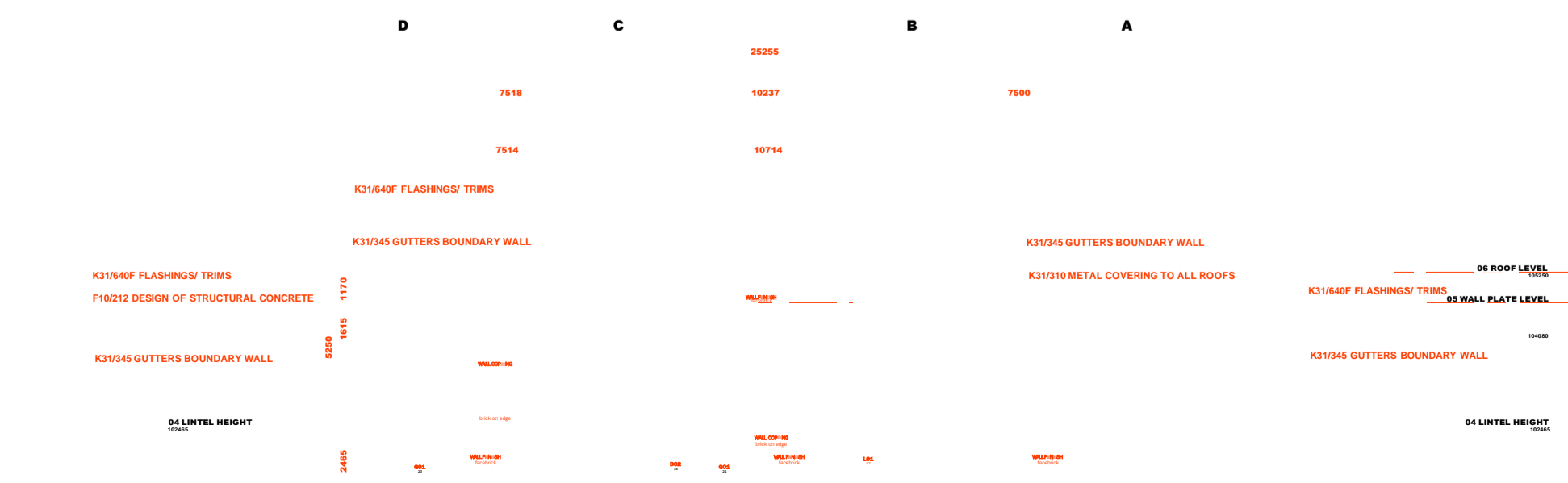
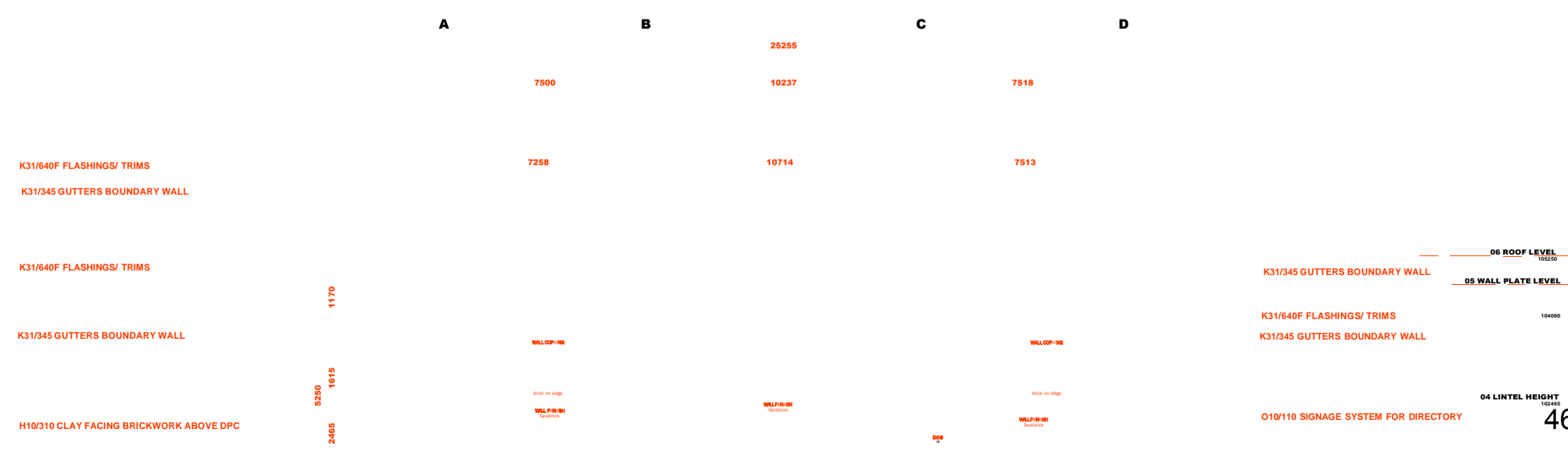
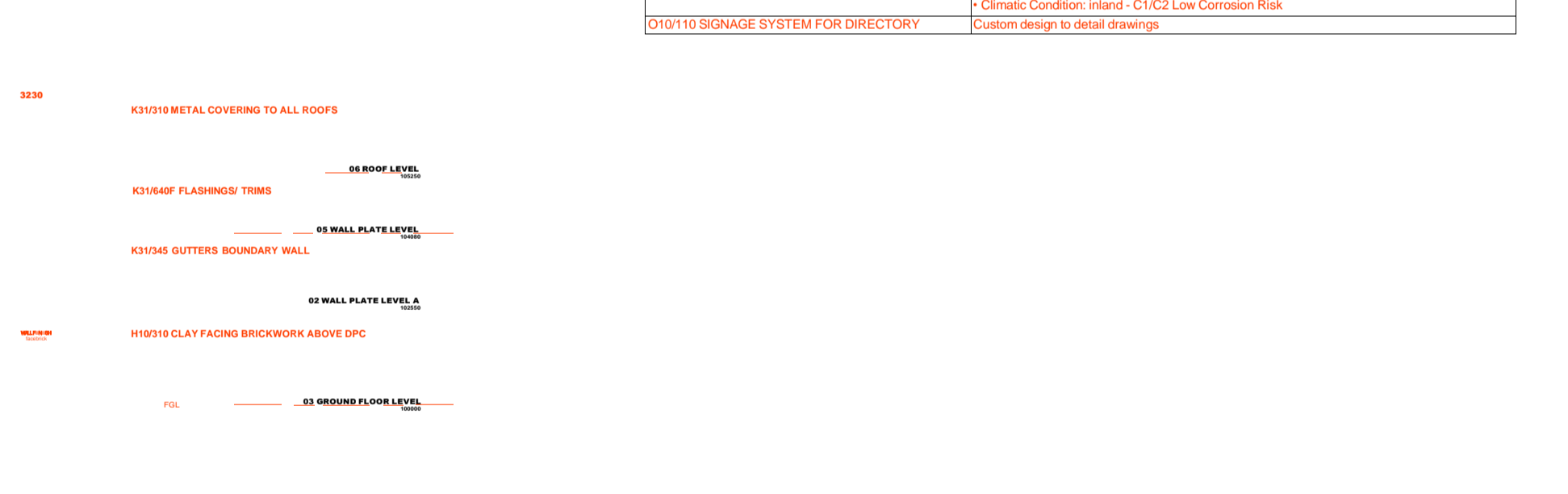
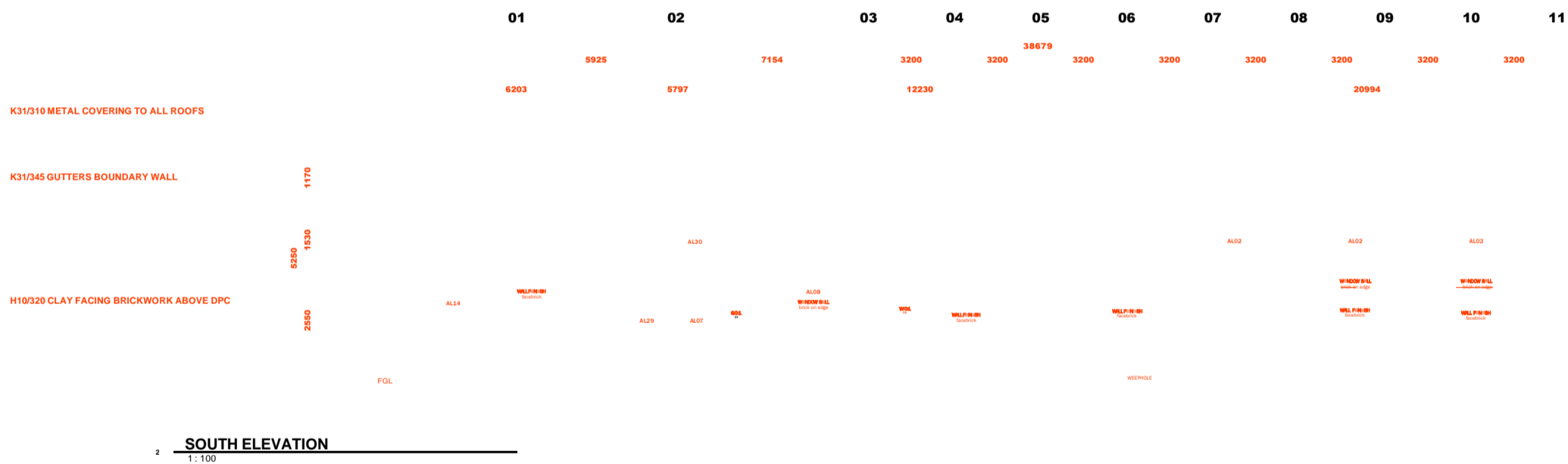

ARCHITECTS

WORKSTAGE	W04	DRAWING SCALE	As indicated	DRAWING NAME	ALUMINIUM SCHEDULE	
DATE	2021/09/01 17:09:11	PROJECT ADDRESS	VARIOUS SITES			
AUTHOR	THC	PROJECT LEADER	AAB	SACAP NUMBER	<input type="text"/>	
		TENDER/PROCUREMENT		DRAWING NUMBER	AS - 6 - 6000 - X00	
					REVISION	<input type="text"/>

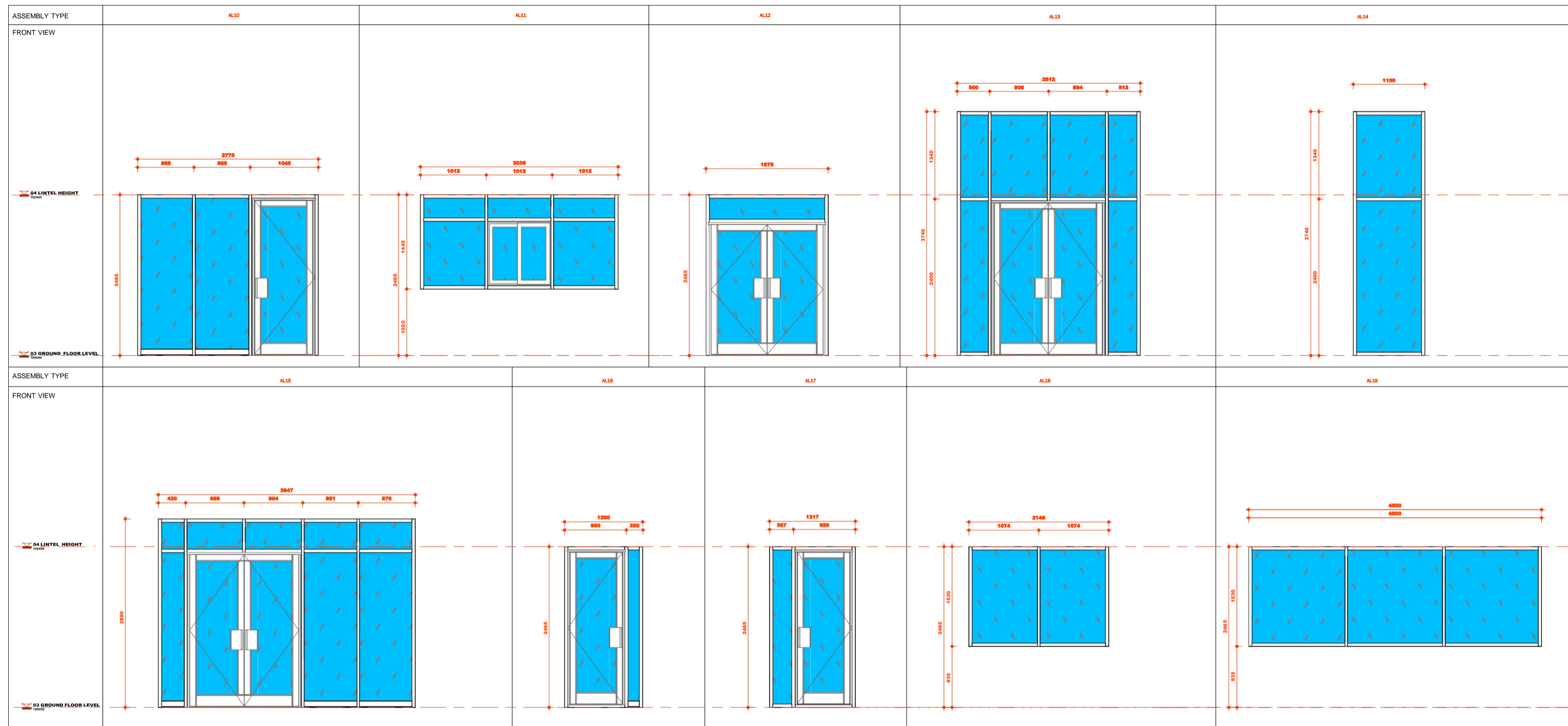

4.1 ASSEMBLY SCHEDULE

Type Mark	SYSTEM		Performance Exposure Category	Performance Class	MULLION AND FRAME STRUCTURE				CURTAIN WALL GLAZING				Count
	System Type	Manufacturer			Mullion Material	Mullion Finish	Mullion Colour	Mullion Cover Cap Material	Mullion Cover Cap Colour	Curtain Wall Glazing Type	Inhomogeneity		
AL10	HBS Aluminium Systems NIKOLP powder coated Aluminium HBS advantage curtain wall system with flush glazing as indicated or Equal Approved. Manufactured and installed by an Approved Specialist Contractor.	External	KAMISA performance class designation A2	Extruded aluminium alloy	Polysulfone powder coating to SANS 1756	Dark Grey Colour code to be verified	Extruded aluminium alloy	Dark Grey Colour code to be verified	Pressure plate and gasket glazing	As per Inhomogeneity Schedule	7		
AL11	HBS Aluminium Systems NIKOLP powder coated Aluminium HBS advantage curtain wall system with flush glazing as indicated or Equal Approved. Manufactured and installed by an Approved Specialist Contractor.	External	KAMISA performance class designation A2	Extruded aluminium alloy	Polysulfone powder coating to SANS 1756	Dark Grey Colour code to be verified	Extruded aluminium alloy	Dark Grey Colour code to be verified	Pressure plate and gasket glazing	As per Inhomogeneity Schedule	1		
AL12	HBS Aluminium Systems NIKOLP powder coated Aluminium HBS advantage curtain wall system with flush glazing as indicated or Equal Approved. Manufactured and installed by an Approved Specialist Contractor.	External	KAMISA performance class designation A2	Extruded aluminium alloy	Polysulfone powder coating to SANS 1756	Dark Grey Colour code to be verified	Extruded aluminium alloy	Dark Grey Colour code to be verified	Pressure plate and gasket glazing	As per Inhomogeneity Schedule	1		
AL13	HBS Aluminium Systems NIKOLP powder coated Aluminium HBS advantage curtain wall system with flush glazing as indicated or Equal Approved. Manufactured and installed by an Approved Specialist Contractor.	External	KAMISA performance class designation A2	Extruded aluminium alloy	Polysulfone powder coating to SANS 1756	Dark Grey Colour code to be verified	Extruded aluminium alloy	Dark Grey Colour code to be verified	Pressure plate and gasket glazing	As per Inhomogeneity Schedule	1		
AL14	HBS Aluminium Systems NIKOLP powder coated Aluminium HBS advantage curtain wall system with flush glazing as indicated or Equal Approved. Manufactured and installed by an Approved Specialist Contractor.	External	KAMISA performance class designation A2	Extruded aluminium alloy	Polysulfone powder coating to SANS 1756	Dark Grey Colour code to be verified	Extruded aluminium alloy	Dark Grey Colour code to be verified	Pressure plate and gasket glazing	As per Inhomogeneity Schedule	1		
AL15	HBS Aluminium Systems NIKOLP powder coated Aluminium HBS advantage curtain wall system with flush glazing as indicated or Equal Approved. Manufactured and installed by an Approved Specialist Contractor.	External	KAMISA performance class designation A2	Extruded aluminium alloy	Polysulfone powder coating to SANS 1756	Dark Grey Colour code to be verified	Extruded aluminium alloy	Dark Grey Colour code to be verified	Pressure plate and gasket glazing	As per Inhomogeneity Schedule	1		
AL16	HBS Aluminium Systems NIKOLP powder coated Aluminium HBS advantage curtain wall system with flush glazing as indicated or Equal Approved. Manufactured and installed by an Approved Specialist Contractor.	External	KAMISA performance class designation A2	Extruded aluminium alloy	Polysulfone powder coating to SANS 1756	Dark Grey Colour code to be verified	Extruded aluminium alloy	Dark Grey Colour code to be verified	Pressure plate and gasket glazing	As per Inhomogeneity Schedule	1		
AL17	HBS Aluminium Systems NIKOLP powder coated Aluminium HBS advantage curtain wall system with flush glazing as indicated or Equal Approved. Manufactured and installed by an Approved Specialist Contractor.	External	KAMISA performance class designation A2	Extruded aluminium alloy	Polysulfone powder coating to SANS 1756	Dark Grey Colour code to be verified	Extruded aluminium alloy	Dark Grey Colour code to be verified	Pressure plate and gasket glazing	As per Inhomogeneity Schedule	1		
AL18	HBS Aluminium Systems NIKOLP powder coated Aluminium HBS advantage curtain wall system with flush glazing as indicated or Equal Approved. Manufactured and installed by an Approved Specialist Contractor.	External	KAMISA performance class designation A2	Extruded aluminium alloy	Polysulfone powder coating to SANS 1756	Dark Grey Colour code to be verified	Extruded aluminium alloy	Dark Grey Colour code to be verified	Pressure plate and gasket glazing	As per Inhomogeneity Schedule	1		
AL19	HBS Aluminium Systems NIKOLP powder coated Aluminium HBS advantage curtain wall system with flush glazing as indicated or Equal Approved. Manufactured and installed by an Approved Specialist Contractor.	External	KAMISA performance class designation A2	Extruded aluminium alloy	Polysulfone powder coating to SANS 1756	Dark Grey Colour code to be verified	Extruded aluminium alloy	Dark Grey Colour code to be verified	Pressure plate and gasket glazing	As per Inhomogeneity Schedule	1		

AUTHOR	THC	PROJECT LEADER	AAB	SACAP NUMBER	
				PLAN NUMBER	

TENDER/PROCUREMENT **AS - 6 - 6001 - X00**

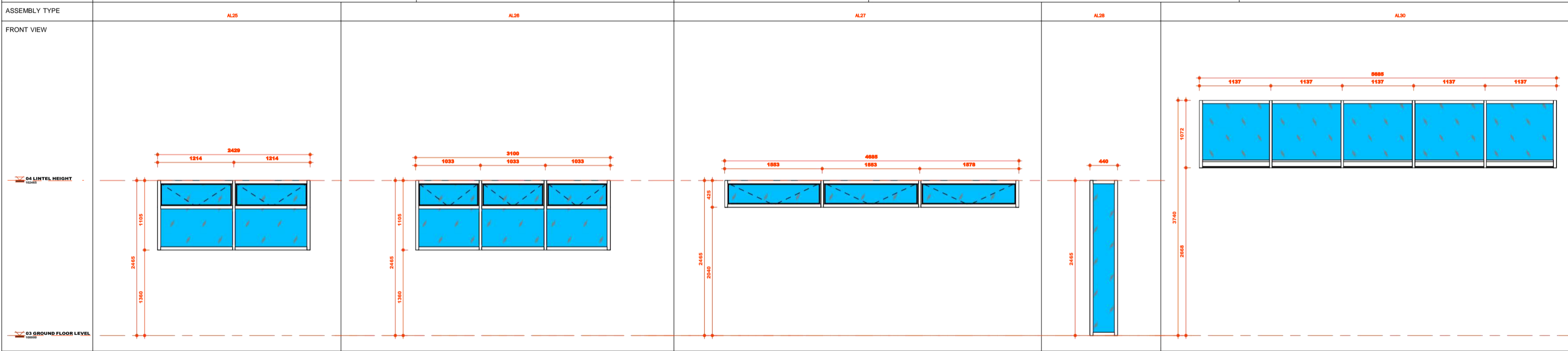
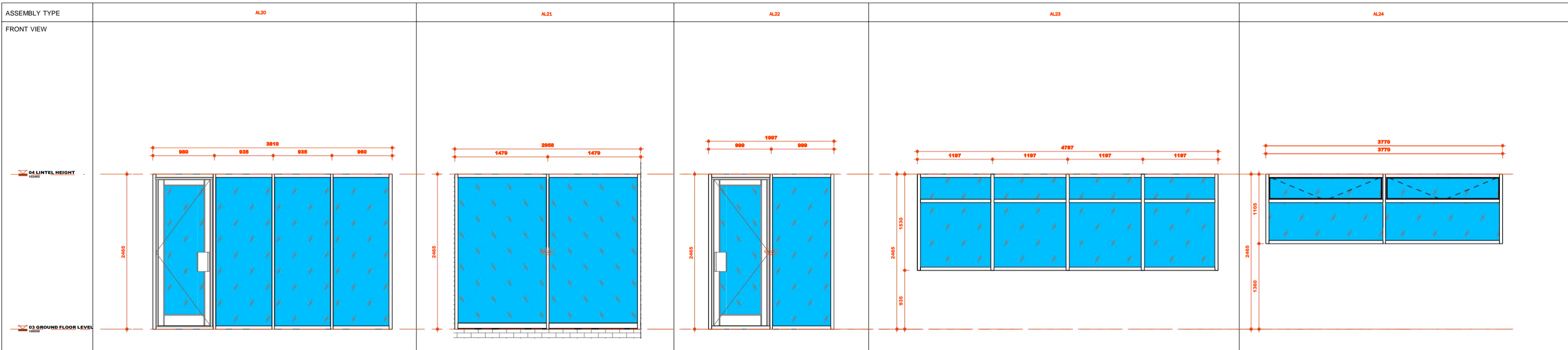

6.1 ASSEMBLY SCHEDULE

Type Mark	System	Performance Exposure Category	Performance Class	Mullion Material	Mullion Finish	Mullion Colour	Mullion and Frame Structure	Mullion Cover Cap Material	Mullion Cover Cap Colour	Curtain Wall Glazing	Insulating	Count
AL20	HBS Aluminium Systems NARLP powder coated Aluminium HBS advantage curtain wall system with flush glazing as indicated or Equal Approved. Manufactured and installed by an Approved Specialist Contractor.	External	KAAMEA performance class designation A2	Extruded aluminium alloy	Polyester powder coating to SANS 1796	Dark Grey (Colour code to be verified)	Extruded aluminium alloy	Extruded aluminium alloy	Dark Grey (Colour code to be verified)	Pressure plate and gasket glazing	As per Homologous Schedule	8
AL21	HBS Aluminium Systems NARLP powder coated Aluminium HBS advantage curtain wall system with flush glazing as indicated or Equal Approved. Manufactured and installed by an Approved Specialist Contractor.	External	KAAMEA performance class designation A2	Extruded aluminium alloy	Polyester powder coating to SANS 1796	Dark Grey (Colour code to be verified)	Extruded aluminium alloy	Extruded aluminium alloy	Dark Grey (Colour code to be verified)	Pressure plate and gasket glazing	As per Homologous Schedule	7
AL22	HBS Aluminium Systems NARLP powder coated Aluminium HBS advantage curtain wall system with flush glazing as indicated or Equal Approved. Manufactured and installed by an Approved Specialist Contractor.	Internal	KAAMEA performance class designation A2	Extruded aluminium alloy	Polyester powder coating to SANS 1796	Dark Grey (Colour code to be verified)	Extruded aluminium alloy	Extruded aluminium alloy	Dark Grey (Colour code to be verified)	Pressure plate and gasket glazing	As per Homologous Schedule	1
AL23	HBS Aluminium Systems NARLP powder coated Aluminium HBS advantage curtain wall system with flush glazing as indicated or Equal Approved. Manufactured and installed by an Approved Specialist Contractor.	Internal	KAAMEA performance class designation A2	Extruded aluminium alloy	Polyester powder coating to SANS 1796	Dark Grey (Colour code to be verified)	Extruded aluminium alloy	Extruded aluminium alloy	Dark Grey (Colour code to be verified)	Pressure plate and gasket glazing	As per Homologous Schedule	1
AL24	HBS Aluminium Systems NARLP powder coated Aluminium HBS advantage curtain wall system with flush glazing as indicated or Equal Approved. Manufactured and installed by an Approved Specialist Contractor.	External	KAAMEA performance class designation A2	Extruded aluminium alloy	Polyester powder coating to SANS 1796	Dark Grey (Colour code to be verified)	Extruded aluminium alloy	Extruded aluminium alloy	Dark Grey (Colour code to be verified)	Pressure plate and gasket glazing	As per Homologous Schedule	1
AL25	HBS Aluminium Systems NARLP powder coated Aluminium HBS advantage curtain wall system with flush glazing as indicated or Equal Approved. Manufactured and installed by an Approved Specialist Contractor.	Internal	KAAMEA performance class designation A2	Extruded aluminium alloy	Polyester powder coating to SANS 1796	Dark Grey (Colour code to be verified)	Extruded aluminium alloy	Extruded aluminium alloy	Dark Grey (Colour code to be verified)	Pressure plate and gasket glazing	As per Homologous Schedule	1
AL26	HBS Aluminium Systems NARLP powder coated Aluminium HBS advantage curtain wall system with flush glazing as indicated or Equal Approved. Manufactured and installed by an Approved Specialist Contractor.	External	KAAMEA performance class designation A2	Extruded aluminium alloy	Polyester powder coating to SANS 1796	Dark Grey (Colour code to be verified)	Extruded aluminium alloy	Extruded aluminium alloy	Dark Grey (Colour code to be verified)	Pressure plate and gasket glazing	As per Homologous Schedule	1
AL27	HBS Aluminium Systems NARLP powder coated Aluminium HBS advantage curtain wall system with flush glazing as indicated or Equal Approved. Manufactured and installed by an Approved Specialist Contractor.	External	KAAMEA performance class designation A2	Extruded aluminium alloy	Polyester powder coating to SANS 1796	Dark Grey (Colour code to be verified)	Extruded aluminium alloy	Extruded aluminium alloy	Dark Grey (Colour code to be verified)	Pressure plate and gasket glazing	As per Homologous Schedule	1
AL28	HBS Aluminium Systems NARLP powder coated Aluminium HBS advantage curtain wall system with flush glazing as indicated or Equal Approved. Manufactured and installed by an Approved Specialist Contractor.	Internal	KAAMEA performance class designation A2	Extruded aluminium alloy	Polyester powder coating to SANS 1796	Dark Grey (Colour code to be verified)	Extruded aluminium alloy	Extruded aluminium alloy	Dark Grey (Colour code to be verified)	Pressure plate and gasket glazing	As per Homologous Schedule	1
AL29	HBS Aluminium Systems NARLP powder coated Aluminium HBS advantage curtain wall system with flush glazing as indicated or Equal Approved. Manufactured and installed by an Approved Specialist Contractor.	Internal	KAAMEA performance class designation A2	Extruded aluminium alloy	Polyester powder coating to SANS 1796	Dark Grey (Colour code to be verified)	Extruded aluminium alloy	Extruded aluminium alloy	Dark Grey (Colour code to be verified)	Pressure plate and gasket glazing	As per Homologous Schedule	1

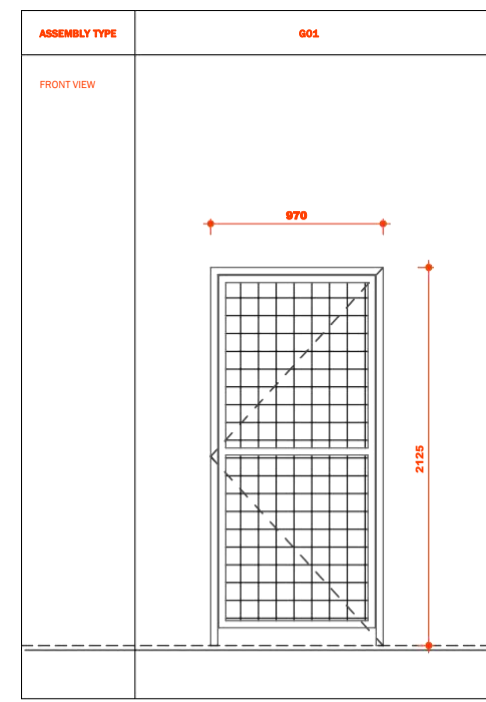
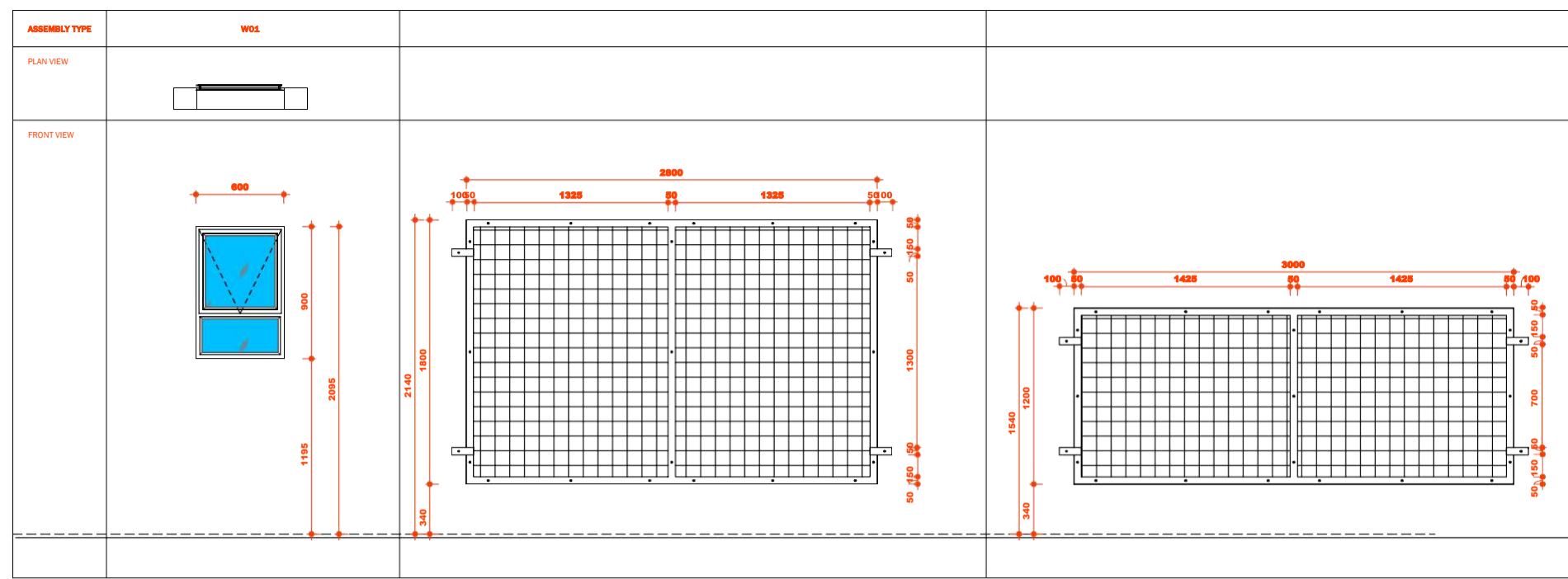

NUMBER	DESCRIPTION	Frame Finish	GLAZING	QUANTITY
L01	50 x 5mm steel flat plate frame with mitred corner joints with 12mm diameter holes for M10 bolts.	CIN 77-730 C-THANE S700 HB FD high built glossy polyurethane enamel applied in strict accordance with the manufacturer's specification.	Steelesteel Bestinace powder coated Universal Fence Panel with 50mm x 50mm aperture and 4mm thick wire diameter in flush cut sheets of 1200mm x 2400mm	2
L02	50 x 5mm steel flat plate frame with mitred corner joints with 12mm diameter holes for M10 bolts.	CIN 77-730 C-THANE S700 HB FD high built glossy polyurethane enamel applied in strict accordance with the manufacturer's specification.	Steelesteel Bestinace powder coated Universal Fence Panel with 50mm x 50mm aperture and 4mm thick wire diameter in flush cut sheets of 1200mm x 2400mm	1
L03	Aluminium 2-panel horizontal sliding window.	Powder coated aluminium - Colour Charcoal Grey	GSA Smart Glass Neutral 6,38mm thick Low E Single Glazed Laminated Safety Glass complying with SANS 10400 Part N, SANS 1263 & SABS 0137 - or Equally approved glazing.	1
W01	Aluminium top hung casement multi-point locking on 36mm super brush window.	Powder coated aluminium - Colour Charcoal Grey	GSA Smart Glass Neutral 6,38mm thick Low E Single Glazed Laminated Safety Glass complying with SANS 10400 Part N, SANS 1263 & SABS 0137 - or Equally approved glazing.	8
Grand total				10

Door No	FRAME TYPE	GATE TYPE	Ironmongery	Quantity
G01	50 x 75mm Galvanised rectangular steel tubular frame with 20 x 6mm thick plate welded onto the inside of the frame to receive fence panel.	Steelesteel Bestinace galvanised mesh BRC Thru Fencing no. B17 with 12-7mm x 75,2mm aperture and 4mm thick wire diameter in flush cut sheets of 440mm x 1480mm.	All as per Ironmongery Schedule.	1
Grand total				1

DOOR NUMBER	FIRE ESCAPE	DOOR TYPE	DOUBLE DOOR MEETING STILES	DOOR FRAME FACTORY FINISH	FRAME TYPE	DOOR FRAME FINAL FINISH	DOOR FRAME HINGES	IRONMONGERY	Quantity
D01		Hardboard Faced Flush Door-Van Achi 40mm thick Horizontal Supawood Meranti door, size 813 x 2032mm high.	Not Applicable.	Primed For Site Painting.	R20mag 1.6mm Grey Oxide Primer pressed steel screeded door frame, to suit door size 813 x 2032mm high for 115mm wall.	Waterbased Satin Finish Coating To Metal.	1.5 Pair 100mm 4.2mm Thick Flanged Hinges as Supplied With Door Frame.	As per Ironmongery Schedule.	14
D02	Escape door to be fitted with Approved panic wale.	Hardboard Faced Flush Door: I) Core: Solid Timber Core of Laminated Sections Faced With 6mm High Density Chipboard. II) Concealed Edge Lippings. Lipped on All Four Edges, 7mm Close Grained Hardwood. III) Performance: Heavy Duty. IV) Finish as Delivered: Primed. V) Size and Configuration as Indicated on The Architect's Door Schedule. Doors to be Delivered with Protection for The Finished Surfaces.	As per Manufacturer's Specification.	Primed For Site Painting.	11mm Thick Double Reinforced Pressed Metal Frame For 230mm brick Wall - Finishes	Waterbased Satin Finish Coating To Metal.	3 Pairs 100mm 4.2mm Thick Flanged Hinges as Supplied With Door Frame.	As per Ironmongery Schedule.	1
D03		Van Achi 40mm thick IVT Horizontal hardwood door, overall size 913 x 2032mm high. Sand down timber surface to a fine smooth surface and apply quality timber sealant prior to installation, all in accordance with manufacturer's recommendations.	Not Applicable.	Primed For Site Painting.	R20mag 1.6 mm double rebate Grey Oxide Primer pressed steel screeded door frame, to custom size doors in Boxer Store, for 230mm wall.	Waterbased Satin Finish Coating To Metal.	1.5 Pair 100mm 4.2mm Thick Flanged Hinges as Supplied With Door Frame.	As per Ironmongery Schedule.	1
D04		Metal Austin-Sales D81 right hand record room with 7-lever security keylock, overall size 760 x 1983 High finished in rustproof undercoat for final painting by contractors.	As per Manufacturer's Specification.	As per Manufacturer's Specification.	As per Manufacturer's Specification.	As per Manufacturer's Specification.	As per Manufacturer's Specification.	As per Manufacturer's Specification.	1
D05		Hardboard Faced Flush Door-Van Achi 40mm thick IVT Horizontal hardwood door, overall size 813 x 2032mm high. Sand down timber surface to a fine smooth surface and apply quality timber sealant prior to installation, all in accordance with manufacturer's recommendations. I) Core: Solid Timber Core of Laminated Sections Faced With 6mm High Density Chipboard. II) Concealed Edge Lippings. Lipped on All Four Edges, 7mm Close Grained Hardwood. III) Performance: Heavy Duty. IV) Finish as Delivered: Primed. V) Size and Configuration as Indicated on The Architect's Door Schedule. Doors to be Delivered with Protection for The Finished Surfaces.	Not Applicable.	Primed For Site Painting.	R20mag 1.6 mm double rebate Grey Oxide Primer pressed steel screeded door frame, to custom size doors in Boxer Store, for 230mm wall.	Waterbased Satin Finish Coating To Metal.	1.5 Pair 100mm 4.2mm Thick Flanged Hinges as Supplied With Door Frame.	As per Ironmongery Schedule.	1
D06		Van Achi 40mm thick IVT Horizontal hardwood door, overall size 913 x 2032mm high. Sand down timber surface to a fine smooth surface and apply quality timber sealant prior to installation, all in accordance with manufacturer's recommendations.	Not Applicable.	Primed For Site Painting.	R20mag 1.6 mm double rebate Grey Oxide Primer pressed steel screeded door frame, to custom size doors in Boxer Store, for 230mm wall.	Waterbased Satin Finish Coating To Metal.	1.5 Pair 100mm 4.2mm Thick Flanged Hinges as Supplied With Door Frame.	As per Ironmongery Schedule.	1
D07		Xpanda Standard chain operated roller shutter in galvanised finish, size 4500mm x 2800mm high with 500mm headroom with 130mm clearance on free side and 315mm clearance on operator side, 75mm wide x 1mm thick slates, 70mm wide side guides, Xpanda Roll-Lok, with pressed steel canopy cover and weather strip T-bar to bottom edge, with perimeter framing plugged and screwed to face at maximum 300mm centres to concrete or brickwork.	Not Applicable.	As per Manufacturer's Specification.	As per Manufacturer's Specification.	As per Manufacturer's Specification.	As per Manufacturer's Specification.	As per Manufacturer's Specification.	2
D08		Xpanda Standard chain operated roller shutter in galvanised finish, size 3500mm x 2500mm high with 500mm headroom with 130mm clearance on free side and 315mm clearance on operator side, 75mm wide x 1mm thick slates, 70mm wide side guides, Xpanda Roll-Lok, with pressed steel canopy cover and weather strip T-bar to bottom edge, with perimeter framing plugged and screwed to face at maximum 300mm centres to concrete or brickwork.	Not Applicable.	As per Manufacturer's Specification.	As per Manufacturer's Specification.	As per Manufacturer's Specification.	As per Manufacturer's Specification.	As per Manufacturer's Specification.	1
Grand total									22

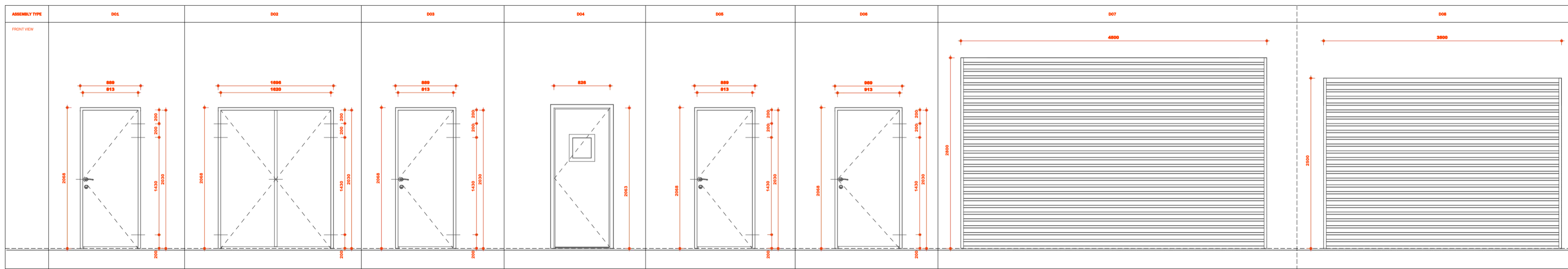

PROJECT ADDRESS: VARIOUS SITES	REVISION				
AUTHOR: THC	PROJECT LEADER: AAB	SACAP NUMBER	DRAWING NUMBER	TENDER/PROCUREMENT	AS - 6 - 6003 - X00

REVISION SCHEDULE

Number Description Date Issued To



4 G014 GROUND FLOOR LEVEL - G014
1:25

WC 02

WC 02

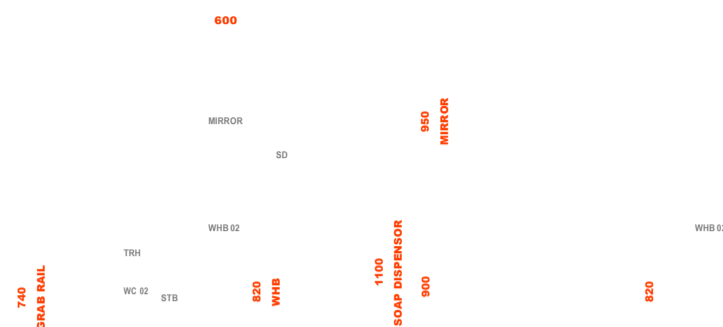

7 G014 ELEVATION 02
1:25

WHB 02

MIRROR

SD

WHB 02

TRH

WC 02

STB

800 WHB

1100 SOAP DISPENSOR 900

820

WHB 02

5 G014 ELEVATION 01
1:25

6 G014 ELEVATION 02
1:25

7 G014 ELEVATION 03
1:25

8 G014 ELEVATION 04
1:25

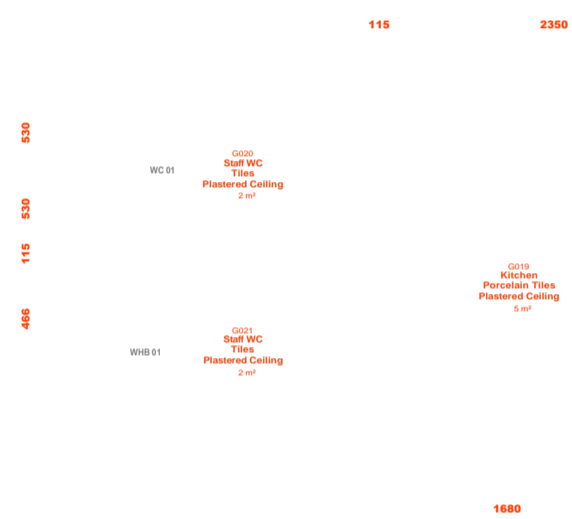

1 G019 GROUND FLOOR LEVEL - G019
1:25

TRH

FE

90

SINK

SINK

S10010 TILING TO WALLS INTERNALLY

WHB 01



20 G019 ELEVATION 04
1:25

17 G019 ELEVATION 01
1:25

18 G019 ELEVATION 02
1:25

19 G019 ELEVATION 03
1:25

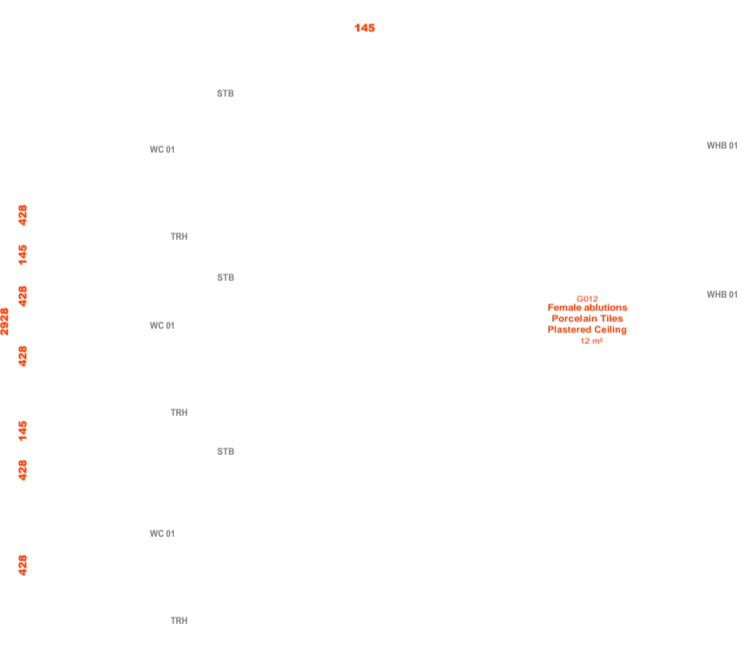

2 G012 GROUND FLOOR LEVEL - G012
1:25

WC 01

STB

SD

WHB 01

MIRROR

MIRROR

WHB 01

WHB 01

WHB 01

WC 01

13 G012 ELEVATION 01
1:25

14 G012 ELEVATION 02
1:25

15 G012 ELEVATION 03
1:25

16 G012 ELEVATION 04
1:25

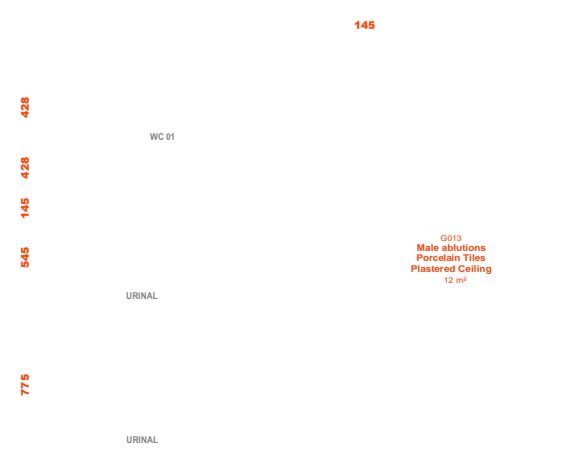

2 G012 ELEVATION 01
1:25

WC 01

WHB 01

WHB 01

WHB 01

WHB 01

URINAL

URINAL

URINAL

TRH

WC 01

890

890

1300

1250

1110

URINAL

890

1110

URINAL

TRH

WC 01

03 GROUND FLOOR LEVEL - G013
1:25

GAUTENG: Unit 2, 107 Sovereign Drive, Midrand, Gauteng
LIMPOPO: 45 Bendor Drive, Hampton City, Limpopo
LEMEG ARCHITECTS C.C. | CK 1988/12540/03 | MEMBERS: EV Barnard (Pr Arch LMSAA F.A.S.A.) | KS Lefth (Pr Arch SAA)

www.lemeg.com

© Copyright is vested in the practice in terms of the Copyright Act of South Africa (Act 98 of 1978)

ALL RIGHTS RESERVED. THE COPYRIGHT OF THIS DRAWING (INCLUDING ALL ATTACHED AND INCORPORATED DOCUMENTS) IS THE PROPERTY OF LEMEG. NEITHER THE FORM OR ANY PART OF IT MAY BE USED OR REPRODUCED BY ANY METHOD WHATSOEVER OR INCORPORATED BY REFERENCE OR IN ANY MANNER WHATSOEVER IN ANY OTHER DOCUMENT WITHOUT THE PRIOR WRITTEN CONSENT OF LEMEG.

G013 ELEVATION 01
1:25

G013 ELEVATION 02
1:25

G013 ELEVATION 03
1:25

CLIENT

DISCLAIMER
"THE REQUIREMENT AND GUIDELINES SET OUT IN THIS DOCUMENT SHALL NOT APPLY OR BE IMPLEMENTED TO THE EXTENT THAT THEY DO NOT MEET THE REQUIREMENTS OF APPLICABLE LAWS AND REGULATIONS. IN ALL CASES, ALL APPLICABLE LEGAL AND REGULATORY REQUIREMENTS MUST BE MET WHEN CONDUCTING ACTIVITIES WITH THIS DOCUMENTS."







G013 ELEVATION 04
1:25







CLIENT: Limpopo Department of Public Works, Roads & Infrastructure
PROJECT NUMBER: 2101
PROJECT NAME: NEW LIBRARIES
WORKSTAGE: W04
DRAWING SCALE: 1:25
DRAWING NAME: SANITARY SCHEDULE
DATE: 2021/09/01 17:09:46
AUTHOR: THC
PROJECT LEADER: AAB
SACAP NUMBER: []
PROJECT ADDRESS: VARIOUS SITES
REVISION: []
DRAWING NUMBER: AS - 6 - 6004 - X00
TENDER/PROCUREMENT

ARCHITECTS



AF-6-SCHEDULES_FINISHES									
NUMBER	NAME	AREA	FINISHES					MECHANICAL SYSTEMS	
			FLOOR FINISH	WALL FINISH	CEILING FINISH	MECHANICAL SYSTEMS	MECHANICAL SYSTEMS		
0001	Paint								
0002	Paint								
0003	Paint								
0004	Paint								
0005	Paint								
0006	Paint								
0007	Paint								
0008	Paint								
0009	Paint								
0010	Paint								
0011	Paint								
0012	Paint								
0013	Paint								
0014	Paint								
0015	Paint								
0016	Paint								
0017	Paint								
0018	Paint								
0019	Paint								
0020	Paint								
0021	Paint								
0022	Paint								
0023	Paint								
0024	Paint								
0025	Paint								
0026	Paint								
0027	Paint								
0028	Paint								
0029	Paint								
0030	Paint								

SANITARY ACCESSORIES		
Type Mark	Description	Image
MIRROR	450mm x 600mm	
PTD	KIMBERLY CLARK SLIMROLL HAND TOWEL DISPENSER	
SD	Stainless Steel Manual Soap Dispenser - 1,250ml - Vertical	
STB	12L SANITARY BIN – PEDAL OPERATED	
TRH	Encore TR2	
WB	18.6L SS wall bin CL-00093	

Plumbing Fixture Schedule					
Type Mark	Description	Accessories	Supply Type	Count	Image
SINK	Manufacturer: Franke Kitchen Systems (PTY) Ltd. Product reference: Projectline PLN611 Stainless Steel Sink Product Code: 310332	Manufacturer: ISCA. Product reference: Sandria Sink Mixers Wall Type Product Code: 3008/13SCCH		1	
URINAL	Manufacturer: Vaal Sanitaryware. Product reference: Lavatera Wall Hung Urinal Product Code: 705427	Walcro 330UR exposed 15 mm BSP urinal flush valve. Made from DZR brass and designed for single bowl urinals.	COLD	2	
WC 01	Toilet Pan Manufacturer: Vaal Sanitaryware Product reference: Hibiscus Elite Closed Coupled Toilet Product Code: 772402 Seat and Cover Manufacturer: Vaal Sanitaryware Product reference: Embassy Seat Product Code: 8530Z0	Front-flush Lever; Right hans side fitted.	COLD	5	
WC 02	Toilet Pan Manufacturer: Vaal Sanitaryware Product reference: Protea Paraplegic Toilet with Cistern Product Code: 750246 Seat & Cover Manufacturer: Vaal Sanitaryware Product reference: Buxton Sta-Tite toilet seat Product Code: 8515Z100	Side-flush lever: Right hand side fitted.	COLD	1	
WHB 01	Manufacturer: Vaal Sanitaryware. Product reference: Daisy Basin Product Code: 700803	Manufacturer: Franke Kitchen Systems (Pty) Ltd. Product reference: AQUALINE-S Self Closing Pillar Tap AQUA201 Product Code: 359744	COLD	5	
WHB 02	Manufacturer: Vaal Sanitaryware. Product reference: Daisy Basin Product Code: 700803	Manufacturer: Idrul Product reference: Single Lever Medical Basin Mixer Product Code: TVID02150	COLD	1	



AUTHOR	THC	PROJECT LEADER	AAB	SACAP NUMBER	
--------	-----	----------------	-----	--------------	--

PROJECT ADDRESS: VARIOUS SITES

REVISION

DRAWING NUMBER



REVISION SCHEDULE

Number	Description	Date	Issued to

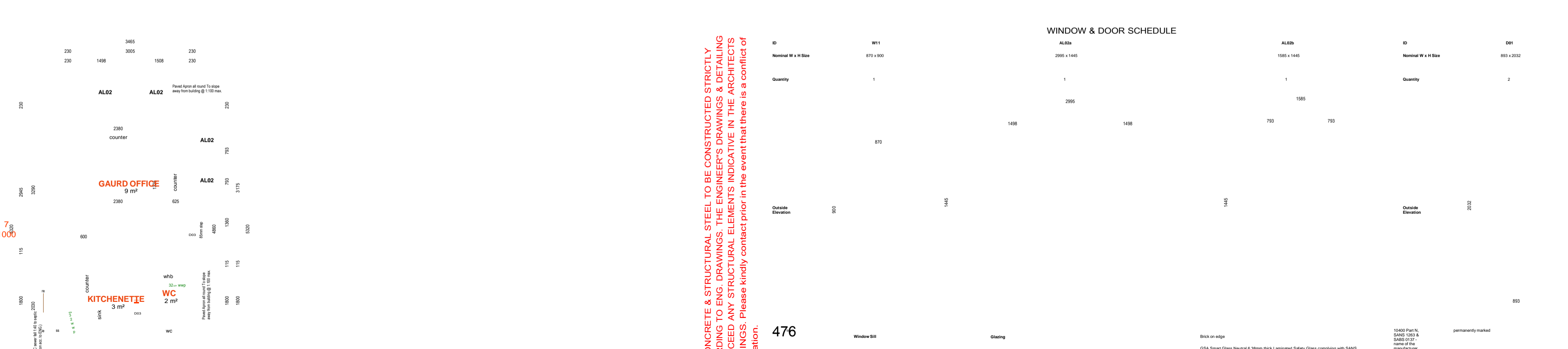
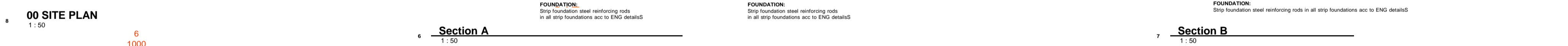
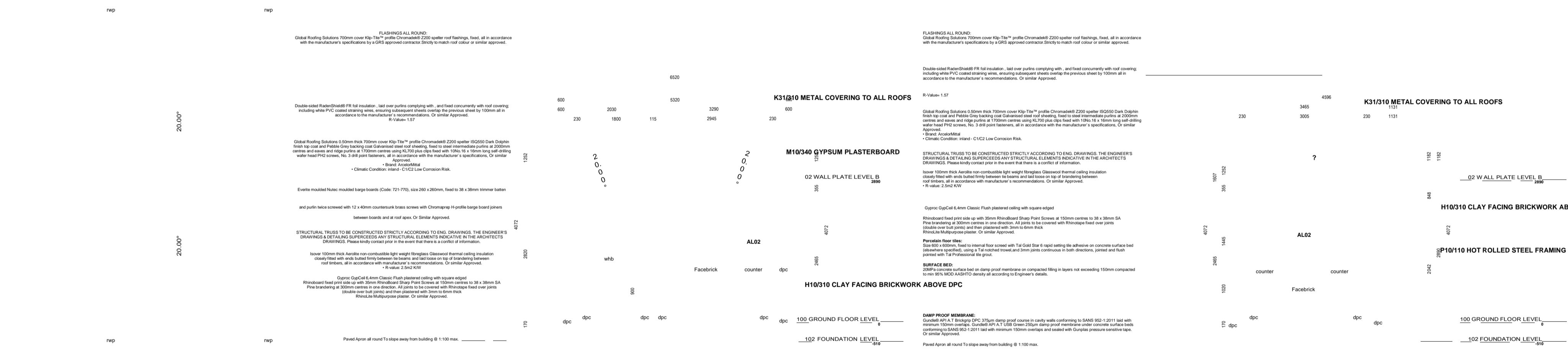
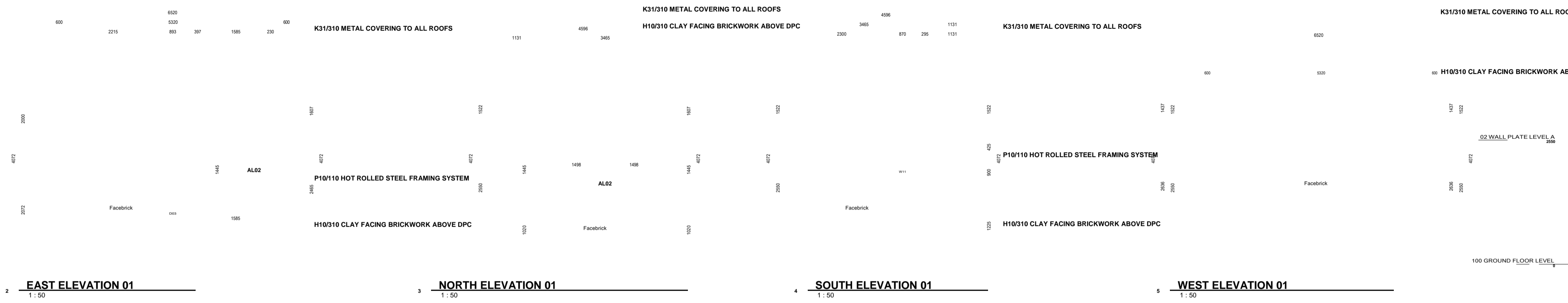

CONCRETE & STRUCTURAL STEEL TO BE CONSTRUCTED STRICTLY ACCORDING TO ENG. DRAWINGS. THE ENGINEER'S DRAWINGS & DETAILING SUPERCEDES ANY STRUCTURAL ELEMENTS INDICATIVE IN THE ARCHITECTS DRAWINGS. Please kindly contact prior in the event that there is a conflict of opinion.

ID	Nominal W x H Size	Quantity	Outside Elevation
W11	870 x 900	1	900
AL02a	2995 x 1445	1	1445
AL02b	1585 x 1445	1	1445
D01	893 x 2032	2	2032

ID	Nominal W x H Size	Quantity	Outside Elevation
AL02a	2995 x 1445	1	1445
AL02b	1585 x 1445	1	1445
D01	893 x 2032	2	2032

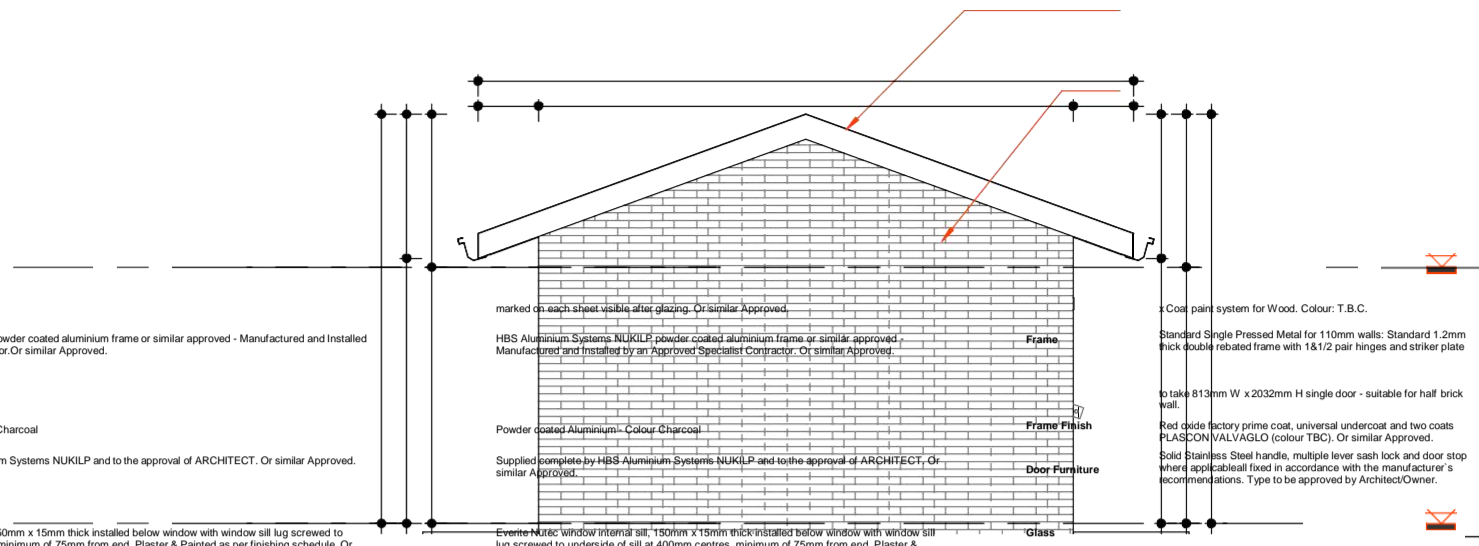
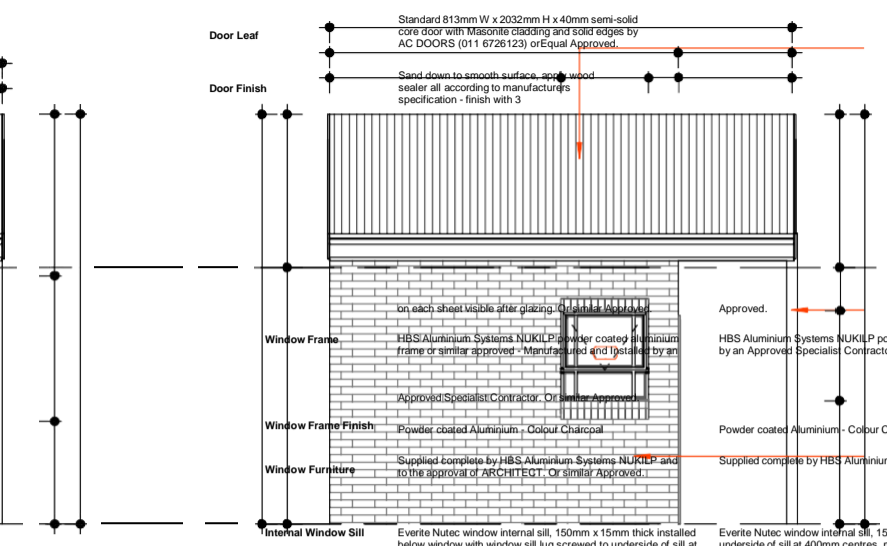
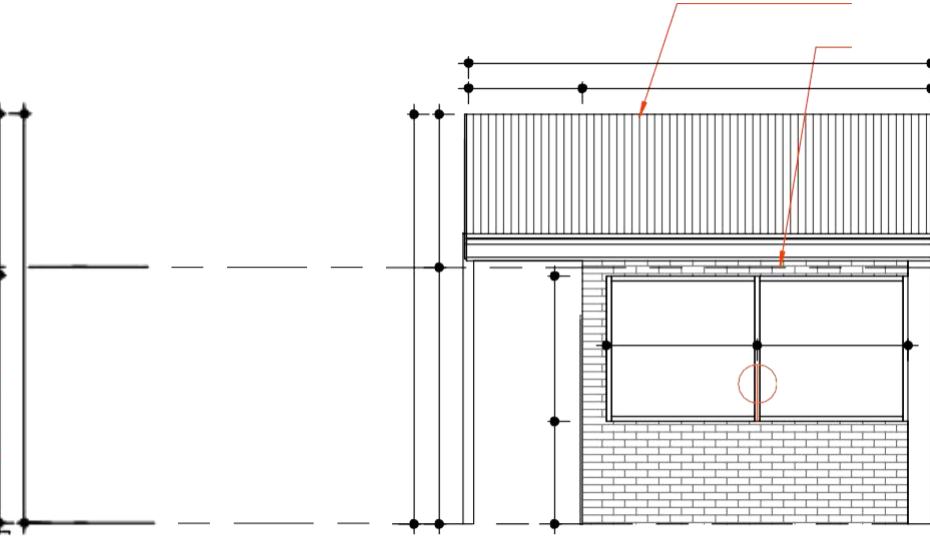
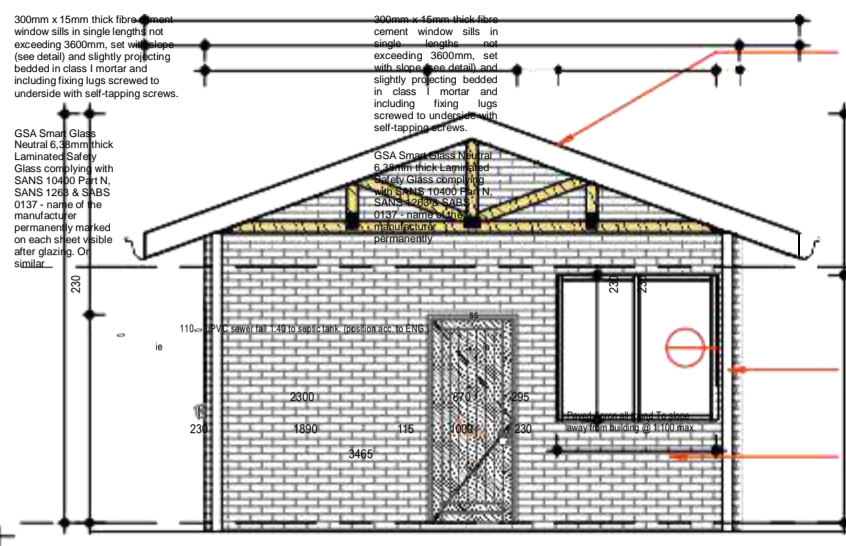

100 GROUND FLOOR LEVEL

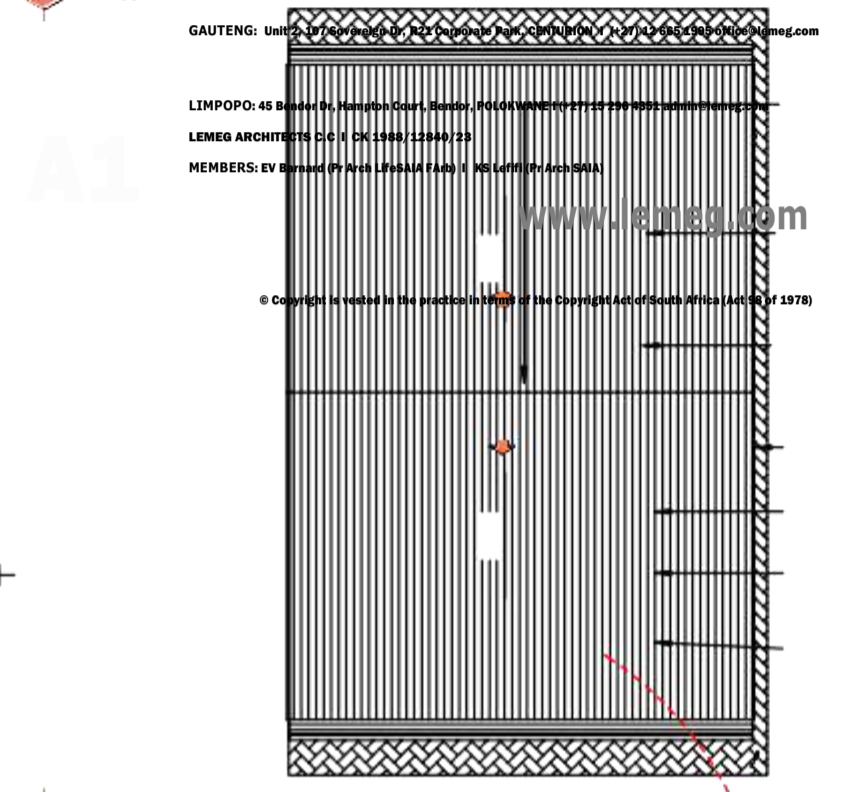

DISCLAIMER

THE REQUIREMENT AND GUIDELINES SET OUT IN THIS DOCUMENT SHALL NOT APPLY OR BE IMPLEMENTED TO THE EXTENT THAT THEY DO NOT MEET THE REQUIREMENTS OF APPLICABLE LAWS AND REGULATIONS. IN ALL CASES, ALL APPLICABLE LEGAL AND REGULATORY REQUIREMENTS MUST BE MET WHEN CONDUCTING ACTIVITIES WITH THIS DOCUMENT.

ALL RIGHTS RESERVED. THE COPYRIGHT OF THIS DRAWING (INCLUDING ALL ATTACHED AND INCORPORATED DOCUMENTS) IS THE PROPERTY OF LEMEG. NEITHER THE FORM OR ANY PART OF IT MAY BE USED OR REPRODUCED BY ANY METHOD WHATSOEVER OR INCORPORATED BY REFERENCE OR IN ANY MANNER WHATSOEVER IN ANY OTHER DOCUMENT WITHOUT THE PRIOR WRITTEN CONSENT OF LEMEG.

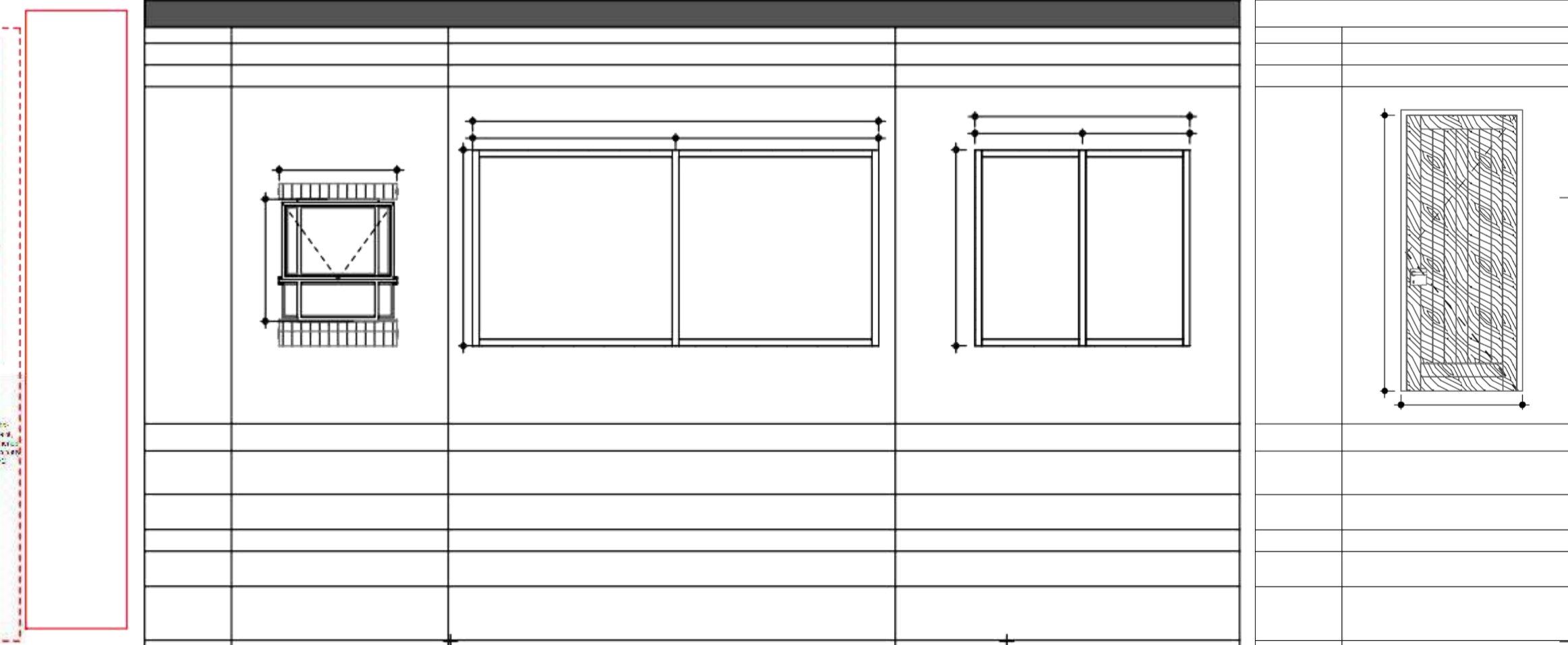
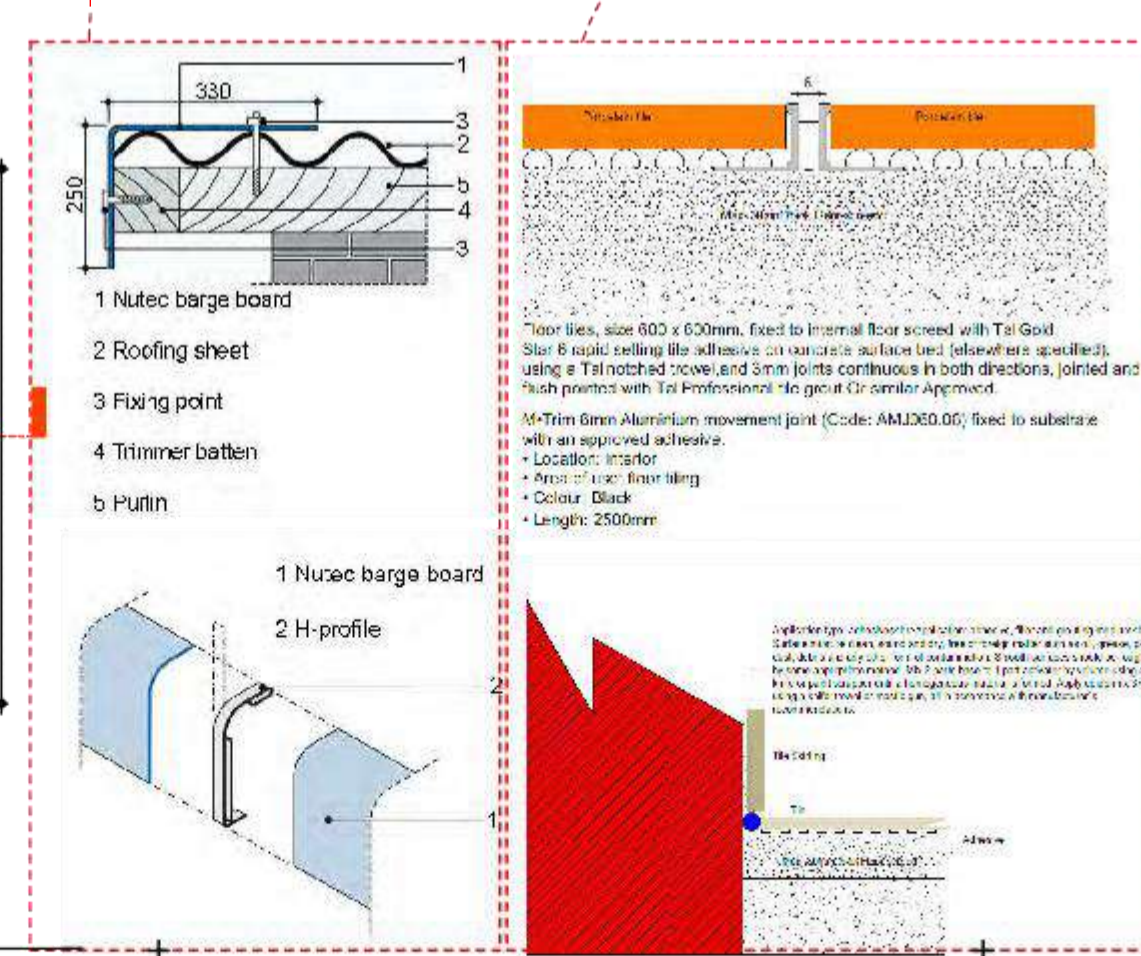
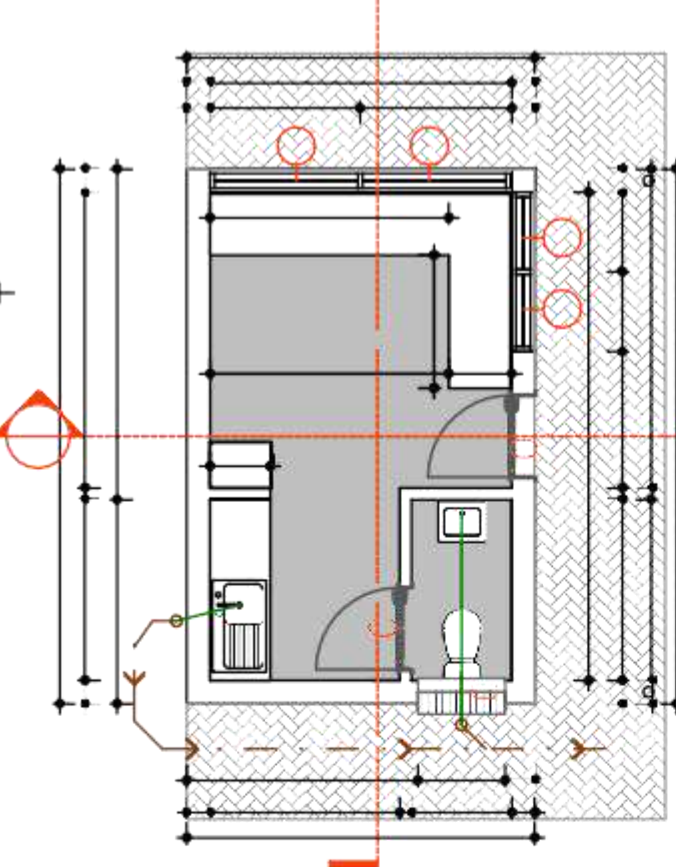
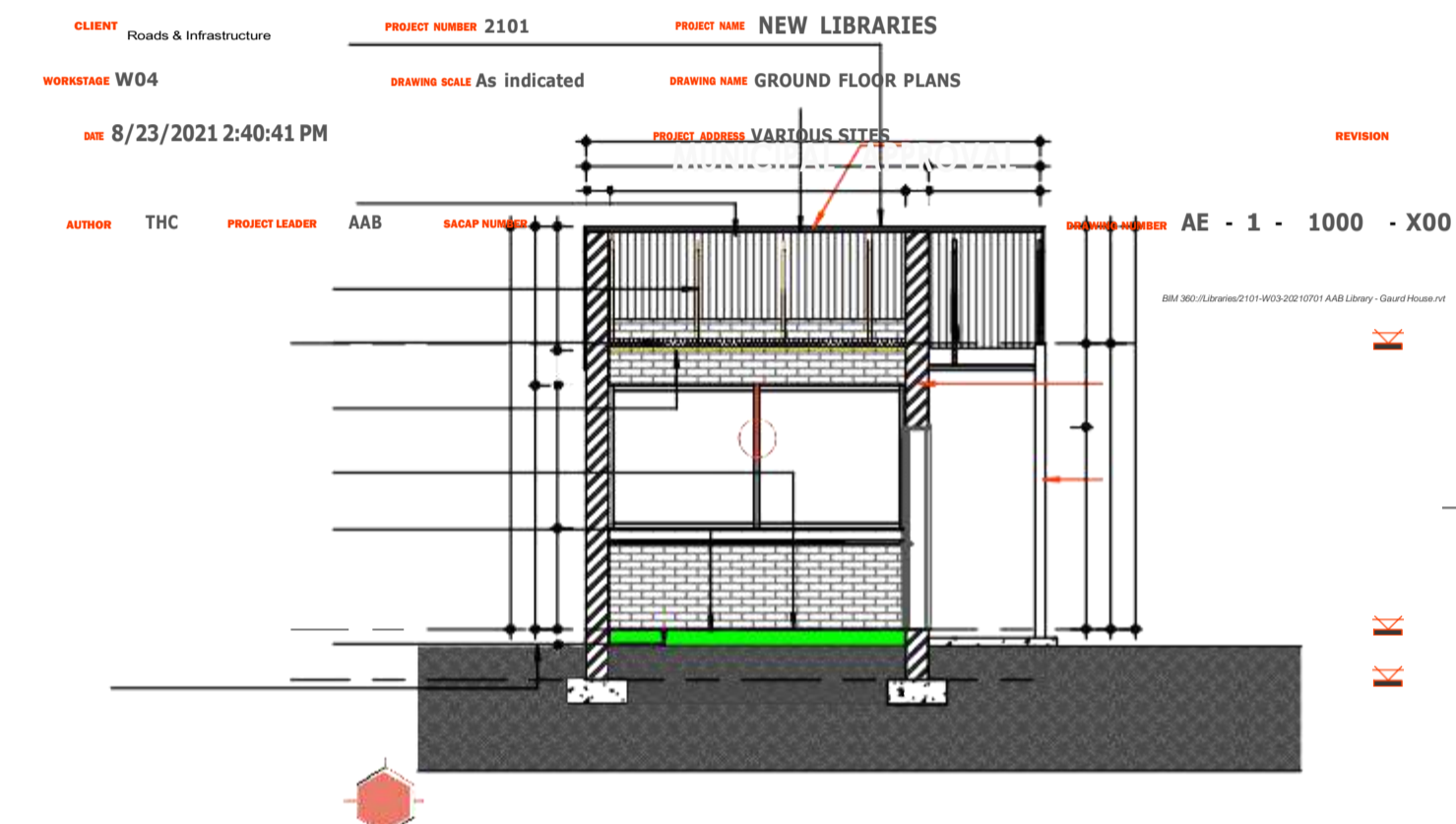
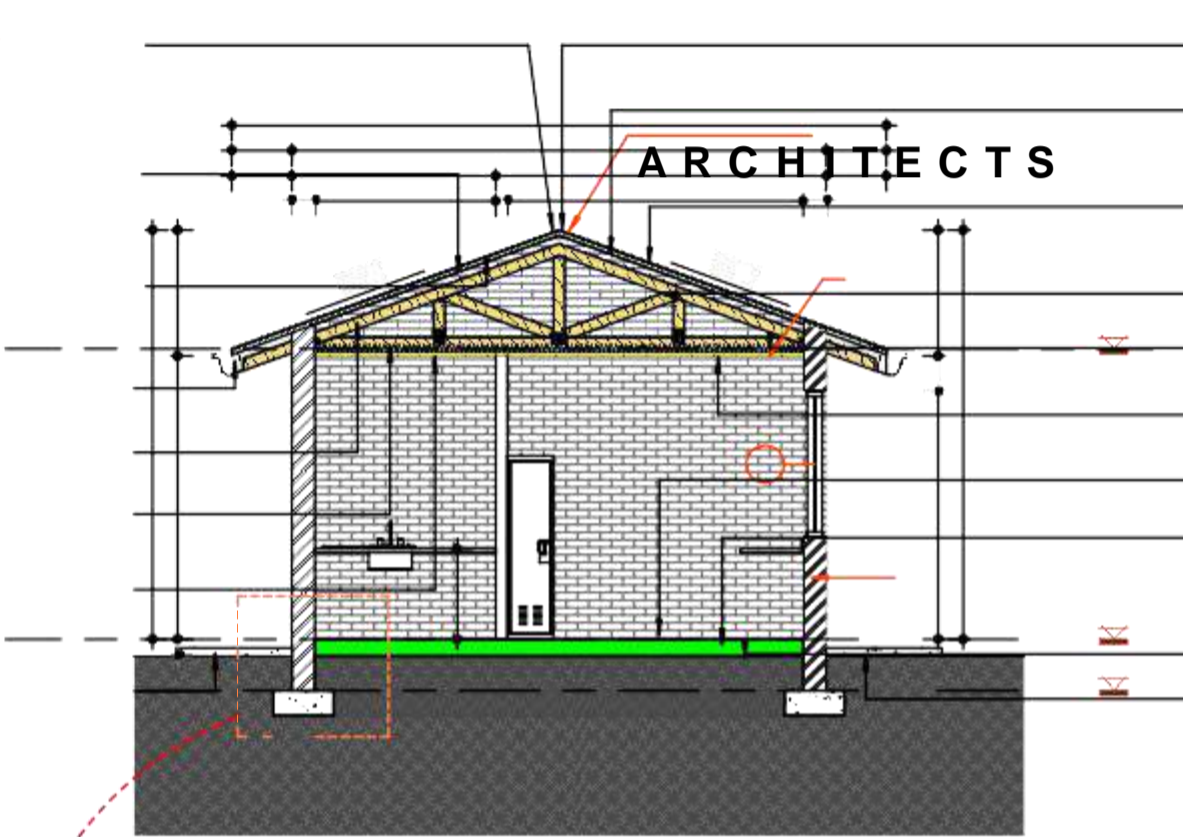

HA-TSHIKOTA-A

EXT 1

745.08
648.08



Cold Water Supply:
32dia. to 22dia. to 15dia. toff to fitting

Domestic Water Supply reticulation to be ring fed .All isolators and valves at junctions and connections to comply

Hot Water Supply:
22 dia. to 15dia. toff to fitting

Domestic Hot Water Supply reticulation to be ring fed .All isolators and valves at junctions and connections to comply . 80mm insulation and lagging to be provided for all exposed copper pipes

T 4.4 Division Area
 T 4.13 Ceilings
 T 4.29 Marking & Sign Posting
 All Marking & sign posting to be done in accordance with SABS 1186
SEE PROPOSALS on SIGNAGE DRAWING

T4.30 Provision for Emergency Lighting
 T 4.31 Fire Detection & Alarm System

T 4.34 Fire Hose Reel 1/500m2
 T 4.35 Fire Hydrant 1/1000m2
 T 4.36 Auto Sprinklers
 T 4.37 Fire Extinguisher 1/200m2

T 4.42 Smoke Control

FE: 9 Kg DPC fire extinguisher charged and hung on bracket fixed to 300 x 800 x 20 thick hardwood backboard with beveled edges and bolted to wall. Backboard to have clear varnish finish
 FHR: 30 m Length of 20mm diameter rubber hose reel mounted on steel brackets and fixed to wall all complete with brass nozzle with holding bracket and C.P. stopcock
 Signage : Allow a Selected Subcontract Amount for general and safety signage

Additional Notes :
 1) All pipes above ground must be of galvanised mild steel as required by SABS 763 or PVC Class 16

FENESTRATION CALCULATIONS

COMPLIANCE WITH SANS 10400: PART XA			
	REQUIRED	ACHIEVED	COMPLIANT
GROSS FLOOR AREA		202.69 m ²	
NETT ENCLOSED FLOOR AREA		175.31 m ²	
BUILDING ENVELOPE			YES
FENESTRATION *AS PER ATTACHED ENERGY EFFICIENCY XA & 204 DOCUMENT	<15%	<15%	YES
ROOF ASSEMBLY			YES
ENERGY DEMAND			YES
HOT WATER PIPING			YES
COMPLIANCE WITH PART D	>5%	<5%	

AS PER THE MAKHADO MUNICIPALITY LAND USE SCHEME AND DEVELOPMENT GUIDELINES

FLOOR STOREY	REQUIRED	ACHIEVED	COMPLIANT
GROUND FLOOR	18 400	18 400	YES
TOTAL GROSS	18 400	18 400	YES
TOTAL NETT	175.31	175.31	YES
GLASS AREA	17%	17%	YES
PARKING	11 parking spots	11 parking spots	YES

04 - WS04 - TOWN PLANNING SCHEDULE Copy 1
1:50

ARCHITECTS

CLIENT: Limpopo Department of Public Works, Roads & Infrastructure

PROJECT NAME: VLEIFONTEIN LIBRARY

DRAWING NAME: LOCALITY PLAN

PROJECT ADDRESS: MAKHADO MUNICIPALITY - VLEIFONTEIN

DATE: 8/10/2021 1:04:56 PM

REVISION: 00591

DRAWING NUMBER: AE - 1 - 1100 - X00

REVISION: 00591

REVISION: 00591

REVISION: 00591

REVISION: 00591

REVISION: 00591

REVISION: 00591

REVISION: 00591

REVISION: 00591

REVISION: 00591

Symbol Requirement	Description	Compliance / Notes
	Fire Alarm (Bell) Indicator	As per 150111: Sign Module (Bell) Indicator to be installed on site by specialist. To be installed in accordance with SANS 10400 Part T and SANS 10400 Part XA.
	Exit Sign on Applicable Floor	As per 150111: Sign Module (Exit) Indicator to be installed on site by specialist. To be installed in accordance with SANS 10400 Part T and SANS 10400 Part XA.
	Escape Route Directional Sign on Applicable Floor	As per 150111: Sign Module (Exit) Indicator to be installed on site by specialist. To be installed in accordance with SANS 10400 Part T and SANS 10400 Part XA.
	Assembly Point	As per 150111: Sign Module (Exit) Indicator to be installed on site by specialist. To be installed in accordance with SANS 10400 Part T and SANS 10400 Part XA.
	Ladies/Men (Water Closet) Sign	As per 150111: Sign Module (Exit) Indicator to be installed on site by specialist. To be installed in accordance with SANS 10400 Part T and SANS 10400 Part XA.
	General Male/Female (Toilet) Sign	As per 150111: Sign Module (Exit) Indicator to be installed on site by specialist. To be installed in accordance with SANS 10400 Part T and SANS 10400 Part XA.
	Paraplegic (Toilet) Sign	As per 150111: Sign Module (Exit) Indicator to be installed on site by specialist. To be installed in accordance with SANS 10400 Part T and SANS 10400 Part XA.
	Electric (Over) Voltage Sign	As per 150111: Sign Module (Exit) Indicator to be installed on site by specialist. To be installed in accordance with SANS 10400 Part T and SANS 10400 Part XA.
	Talkie (Over) Voltage Sign	As per 150111: Sign Module (Exit) Indicator to be installed on site by specialist. To be installed in accordance with SANS 10400 Part T and SANS 10400 Part XA.
	Directional (Toilet) Sign	As per 150111: Sign Module (Exit) Indicator to be installed on site by specialist. To be installed in accordance with SANS 10400 Part T and SANS 10400 Part XA.

LEVELS & BENCHMARK NOTE
Set up a site datum level based on an established benchmark, as directed by the Surveyor to Coordinate with Engineer's specifications and details. Maintain and protect this benchmark

GAUTENG: Unit 2, 107 Sovereign Drive, Route 21 Corporate Park, CENTURION | Office: (+27) 12 665 1995 | Email: office@lemeg.com
LIMPOPO: 45 Bendor Drive, Hampton Court, Bendor Park, POLOKWANE | Office: (+27) 15 296 4351 | Email: admin@lemeg.com

LEMEG ARCHITECTS C.C. | CK 1888/258023 | MEMBERS: EV Barnard (Pr. Arch. Lic/SAA F&B) | KS Lahr (Pr. Arch. Lic/SAA F&B)

www.lemeg.com

Copyright is vested in the practice in terms of the Copyright Act 64 of 1978 and the Copyright Amendment Act 43 of 2003.

ALL RIGHTS RESERVED. THE COPYRIGHT OF THIS DRAWING INCLUDING ALL ATTACHED AND INCORPORATED DOCUMENTS IS THE PROPERTY OF LEMEG ARCHITECTS C.C. AND SHALL NOT BE USED OR REPRODUCED BY ANY PARTY WITHOUT THE WRITTEN CONSENT OF LEMEG ARCHITECTS C.C.

DISCLAIMER: THE REQUIREMENTS AND GUIDELINES SET OUT IN THIS DOCUMENT SHALL NOT APPLY OR BE IMPLEMENTED TO THE EXTENT THAT THEY DO NOT MEET THE REQUIREMENTS OF APPLICABLE LAWS AND REGULATIONS. IN ALL CASES, ALL APPLICABLE LAWS AND REGULATORY REQUIREMENTS MUST BE MET WHEN CONDUCTING ACTIVITIES WITH THIS DOCUMENT.

CLIENT: Limpopo Department of Public Works, Roads & Infrastructure

PROJECT NAME: VLEIFONTEIN LIBRARY

DRAWING NAME: LOCALITY PLAN

PROJECT ADDRESS: MAKHADO MUNICIPALITY - VLEIFONTEIN

DATE: 8/10/2021 1:04:56 PM

REVISION: 00591

DRAWING NUMBER: AE - 1 - 1100 - X00

REVISION: 00591

REVISION: 00591

REVISION: 00591

REVISION: 00591

REVISION: 00591

REVISION: 00591

REVISION: 00591

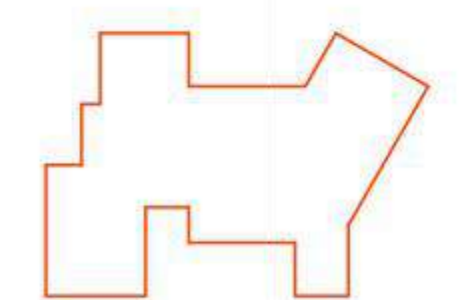
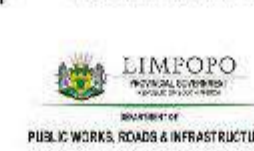

003642034
X:2688300

003642034
X:2688300

HA-TSHIKOTA-A
EXT 1

STREET
25m

745.08
648.08

Cold Water Supply:
32dia. to 22dia. to 15dia. toff to fitting
Domestic Water Supply reticulation to be ring fed .All isolators
and valves at junctions and connections to comply



Hot Water Supply:
22 dia. to 15dia. t-off to fitting

Domestic Hot Water Supply reticulation to be ring fed .All isolators and valves at junctions and connections to comply . 80mm insulation and lagging to be provided for all exposed copper pipes

T 4.4 Division Area
 T 4.13 Ceilings
 T 4.29 Marking & Sign Posting
 All Marking & sign posting to be done in accordance with SABS 1186
 SEE PROPOSALS on SIGNAGE DRAWING

PORTION 8

VLEYFONTEIN 316 L-S

T4.30 Provision for Emergency Lighting
 T 4.31 Fire Detection & Alarm System

T 4.34 Fire Hose Reel 1/500m2
 T 4.35 Fire Hydrant 1/1000m2
 T 4.36 Auto Sprinklers
 T 4.37 Fire Extinguisher 1/200m2

T 4.42 Smoke Control

FE: 9 Kg DPC fire extinguisher charged and hung on bracket fixed to 300 x 800 x 20 thick hardwood backboard with beveled edges and bolted to wall. Backboard to have clear varnish finish
 FHR: 30 m Length of 20mm diameter rubber hose reel mounted on steel brackets and fixed to wall all complete with brass nozzle with holding bracket and C.P. stopcock
 Signage : Allow a Selected Subcontract Amount for general and safety signage



Additional Notes :
 1) All pipes above ground must be of galvanised mild steel as required by SABS 763 or PVC Class 16
 2) Pipes above ground must be of galvanised mild

Levels & Benchmark NOTE

Set up a site datum level based on an established benchmark, as directed by the Surveyor to Coordinate with Engineer's specifications and details. Maintain and protect this benchmark.

Description	Symbol and Colour	Notes
Existing Spot Height	Green circle with 'x'	As per Surveyor's Report
Proposed Spot Height	Red circle with 'x'	As per Surveyor's Report
Proposed Level	Blue circle with 'x'	As per Surveyor's Report

GAUTENG: Unit 2, 107 Bovenburg Drive, Route 21 Corporate Park, CENTURION | Office (27) 12 665 1965 | Email: info@terreg.com

LIMPOPO: 45 Bendor Drive, Hampton Court, Polokwane | Office (27) 15 296 4351 | Email: info@terreg.com

MEMBERS: EV Barendse (P. Arch LMSA/FAIR) | KS Liffers (P. Eng. LMSA/FAIR) | www.terreg.com

Copyright © 2021 Terreg Architects

TOTAL GROSS	REQUIRED	GROSS AREA
STAND/ERV NO.	NEW BUILDING	745 7m ²
DATE AREA	GUARDHOUSE	18 4m ²
COVERAGE		764 1m ²
FAR	60%	VLEIFONTEIN
PARKING		4538 13m ²
PARKING Required Provided @ 2.5 per 100sqm for 745.7m ² Leasable Floor Total	REQUIRED	PROVIDED
	8.645 PER 100 sq FLOOR AREA	11 parking bays

FENESTRATION CALCULATIONS

04 - WS04 - TOWN PLANNING SCHEDULE Copy 1

1:50

	REQUIRED	ACHIEVED	COMPLIANT
GROSS FLOOR AREA		202.69 m ²	
NETT ENCLOSED FLOOR AREA		175.31 m ²	
BUILDING ENVELOPE			YES
FENESTRATION	<15%	<15%	YES
ROOF ASSEMBLY			YES
ENERGY DEMAND			YES
HOT WATER PIPING			YES
COMPLIANCE WITH PART O	>5%	<5%	YES



Fire Supply Point

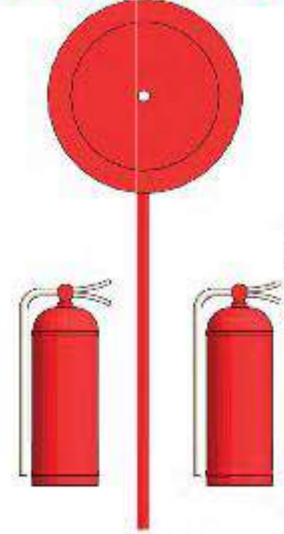

CLIENT Limpopo Department of Public Works, Roads & Infrastructure	PROJECT NUMBER 2101	PROJECT NAME VLEIFONTEIN LIBRARY
WORKSTAGE WS03	DRAWING SCALE As Indicated	DRAWING NAME SDP
DATE 8/10/2021 1:00:36 PM		PROJECT ADDRESS MAKHADO MUNICIPALITY - VLEIFONTEIN
AUTHOR NJ	PROJECT LEADER AAB	DRAWING NUMBER AE - 1 - 1000 - X00

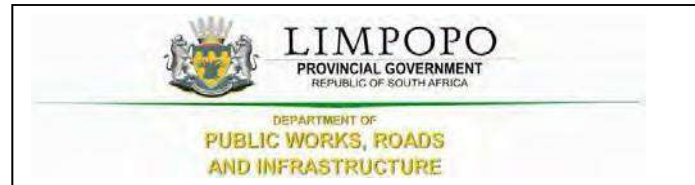

PART C7.2. 2: ELECTRICAL SPECIFICATIONS AND DRAWINGS

CONTENTS

SPECIFICATION FOR ELECTRICAL INSTALLATION:

1. PART 1 GENERAL
2. PART 2 ELECTRICAL INSTALLATION DETAILS
3. PART 3 QUALITY SPECIFICATIONS FOR MATERIAL AND EQUIPMENT OF ELECTRICAL INSTALLATIONS
4. PART 4 BILLS OF QUANTITIES
5. PART 5 SCHEDULE OF MATERIAL
6. PART 6 DRAWINGS

SPECIFICATION FOR ELECTRICAL INSTALLATIONS

PART 1: GENERAL

CONTENTS

CLAUSE	DESCRIPTION	PAGE
1	SCOPE OF WORKS	3
2	DRAWINGS	3
3	REGULATIONS	4
4	NOTICES AND FEES	4
5	SCHEDULE OF FITTINGS	4
6	QUALITY OF MATERIALS	5
7	CONDUIT AND ACCESSORIES	5-6
8	CONDUIT IN ROOF SPACES	6
9	SURFACE MOUNTED CONDUIT	6-7
10	CONDUIT IN CONCRETE SLABS	7
11	FLEXIBLE CONNECTIONS FOR CONNECTING UP OF STOVES, MACHINES, ETC	7
12	WIRING	8
13	SWITCHES AND SOCKET OUTLETS	8
14	SWITCHGEAR	8
15	SWITCHBOARDS	9
16	WORKMANSHIP AND STAFF	9
17	CERTIFICATE OF COMPLIANCE	9
18	EARTHING OF INSTALLATION	9-11
19	MOUNTING AND POSITIONING OF LUMINAIRES	11

GENERAL SPECIFICATION FOR ELECTRICAL WORK

PART 1

1 SCOPE OF WORKS

This quality specification describes the standards of the materials required for the electrical installation and general methods of installing these materials and is the basis of quality control requirements. It compliments the bill of quantities, the drawings and the detailed specification for the specific contract. Where the detailed specification and/ or the drawings differ from this quality technical specification the detailed specification and the drawings shall take precedence.

This contract shall allow for the complete supply, delivery on site, complete installation, testing and handing over in complete working order of the electrical installation as specified further herein.

- a) Supply and installation of low voltage supply cables from the nearest existing mini substation / overhead transformer to the internal main distribution kiosk.
- b). Supply and installation of energy saving light fittings
- c). Supply and installation of power sockets outlets
- d). Supply and installation of data networks wire ways
- e). Supply and installation of indoor distribution boards

2 DRAWINGS

The Engineer's drawings covering the various sections of the installation are as stipulated below form part of this contract. The working drawings applicable to this contract shall generally consist of:

ID	DRAWING NO	TITLE	SIZE	REV	REV DATE
	VL - C - BE - TCS - TDW - 000 - A	Site Power Reticulation	A1	0	08-09-21
	VL - C - BE - TCS - TDW - 003/1/1 - A	Site Main Kiosk - SLD Layout	A1	0	08-09-21
	VL - C - BE - TCS - TDW - 010 - A	Site Area Lighting	A1	0	08-09-21
	VL - C - BE - TCS - TDW - 002/2 - A	Guard House - Lights Layout	A1	0	08-09-21
	VL - C - BE - TCS - TDW - 001/2 - A	Guard House - Power Layout	A1	0	08-09-21
	VL - C - BE - TCS - TDW - 003/1/3 - A	Guard House - SLD Layout	A1	0	08-09-21
	VL - C - BE - TCS - TDW - 004/2 - A	Guard House - LPS Layout	A1	0	08-09-21
	VL - C - BE - TCS - TDW - 005/1 - A	Library Floor - Trunking Layout	A1	0	08-09-21
	VL - C - BE - TCS - TDW - 002/1 - A	Library Floor r - Lights Layout	A1	0	08-09-21
	VL - C - BE - TCS - TDW - 001/1 - A	Library Floor - Power Layout	A1	0	08-09-21
	VL - C - BE - TCS - TDW - 003/1/2 - A	Library Floor - SLD Layout	A1	0	08-09-21
	VL - C - BE - TCS - TDW - 004/1 - A	Library Floor - LPS Layout	A1	0	08-09-21
	VL - C - BE - TCS - TDW - 006/1 - A	Library Floor - CCTV Layout	A1	0	08-09-21

3 REGULATIONS

The installation shall be constructed and tested in accordance with the following Acts and regulations:

- a) The latest issue of SABS 0142: "Code of Practice for the Wiring of Premises",
- b) The Occupational Health and Safety Act, 1993 (Act 85 of 1993) ,
- c) The Local Government Act 1998 (Act 10 of 1998 municipal by-laws and any special requirements of the local supply authority,
- d) The Fire Brigade Services Act 1993 Act 2000 (Act 14 of 2000),
- e) The National Building Regulations and Building Standards Act 1996 (Act 29 of 1996),
- f) The Post Office Act 1998 (Act 14 of 1998),
- g) The Electricity Act 1996 (Act 88 of 1996) and
- h) The Regulations of the local Gas Board where applicable.

4 NOTICES AND FEES

The successful tenderer for this contract shall, immediately after he has been officially notified that his tender has been accepted, and at any time thereafter as may be necessary, notify the Supply Authority, pay fees and take any other steps which may be required or prescribed for the power

Supply connection and/ or temporary connection by the Supply Authority, to this project.

5 SCHEDULE OF FITTINGS

In all instances where schedule of light, socket outlet and power points are attached to or included on the drawings, these schedules are to be regarded as forming part of the specification.

6 QUALITY OF MATERIALS

Only materials of first class quality shall be used and all materials shall be subject to the approval of the Engineer. Wherever applicable the material is to comply with the relevant South African Bureau of Standards, specifications, or to British Standard Specifications, where no SABS Specifications exist.

Materials wherever possible, must be of South African manufacture.

7 CONDUIT AND ACCESSORIES

The type of conduit and accessories required for the service, i.e. whether the conduit and accessories shall be of the screwed type, plain-end type or of the non-metallic type and whether metallic conduit shall be black enamelled or galvanised, is specified in Part 2 of this specification.

Unless other methods of installation are specified for certain circuits, the installation shall be in conduit throughout. No open wiring in roof spaces or elsewhere will be permitted.

The conduit and conduit accessories shall comply fully with the applicable SABS specifications as set out below and the conduit shall bear the mark of approval of the South African Bureau of Standards.

- a) Screwed metallic conduit and accessories: SABS 1065, parts 1 and 2.
- b) Plain-end metallic conduit and accessories: SABS 1065, parts 1 and 2.
- c) Non-metallic conduit and accessories: SABS 950

All conduit fittings except couplings shall be of the inspection type. Where cast metal conduit accessories are used, these shall be of malleable iron. Zinc base fittings will not be allowed.

Bushes used for metallic conduit shall be brass and shall be provided in addition to locknuts at all points where the conduit terminates at switchboards, switch-boxes, draw-boxes, etc.

Draw-boxes are to be provided in accordance with the "Wiring Code" and wherever necessary to facilitate easy wiring.

For light and socket outlet circuits, the conduit used shall have an external diameter of 20mm. In all other instances the sizes of conduit shall be in accordance with the "Wiring Code" for the specified number and size of conductors, unless otherwise directed in part 2 of this specification or indicated on the drawings.

Only one manufactured type of conduit and conduit accessories will be permitted throughout the installation.

Running joints in screwed conduit are to be avoided as far as possible and all conduit systems shall be set or bent to the required angles. The use of normal bends must be kept to a minimum with exception of larger diameter conduits where the use of such bends is essential.

All metallic conduit shall be manufactured of mild steel with a minimum thickness of 1,2mm for plain-end conduit and 1,6mm in respect of screwed conduit.

Under no circumstances will conduit having a wall thickness of less than 1,6 mm be allowed in screeding laid on top of concrete slabs.

Bending and setting of conduit must be done with special bending apparatus manufactured for the purpose and which are obtainable from the manufacturers of the conduit systems.

Damage to conduit resulting from the use of incorrect bending apparatus or methods applied must on indication by the Engineer's inspectorate staff, be completely removed and rectified and any wiring already drawn into such damaged conduits must be completely renewed at the Contractor's expense.

Conduit and conduit accessories used for flame-proof or explosion proof installations and for the suspension of luminaires as well as all load bearing conduit shall in all instances be of the metallic screwed type.

All conduit and accessories used in areas within 50 km of the coast shall be galvanised to SABS 763.

Tenderers must ensure that general approval of the proposed conduit system to be used is obtained from the local electricity supply authority prior to the submission of their tender. Under no circumstances will consideration be given by the Engineer to any claim submitted by the Contractor which may result from a lack of knowledge in regard to the supply authority's requirements.

8 CONDUIT IN ROOF SPACES

Conduit in roof spaces shall be installed parallel or at right angles to the roof members and shall be secured at intervals not exceeding 1,5m by means of saddles screwed to the roof timbers.

Nail or crampets will not be allowed.

Where non-metallic conduit has been specified for a particular service, the conduit shall be supported and fixed with saddles with a maximum spacing of 450 mm. The Contractor shall supply and install all additional supporting timbers in the roof space as required.

Under flat roofs, in false ceilings or where there is less than 0,9m of clearance, or should the ceilings be insulated with glass wool or other insulating material, the conduit shall be installed in such a manner as to allow for all wiring to be executed from below the ceilings.

Conduit runs from distribution boards shall, where possible terminate in fabricated sheet steel draw-boxes installed directly above or in close proximity to the boards.

9 SURFACE MOUNTED CONDUIT

Wherever possible, the conduit installation is to be concealed in the building work; however, where unavoidable or otherwise specified under Part 2 of the specification, conduit installed on the surface must be plumbed or levelled and only straight lengths shall be used.

The use of inspection bends is to be avoided and instead the conduit shall be set uniformly and inspection coupling used where necessary.

No threads will be permitted to show when the conduit installation is complete, except where running couplings have been employed.

Running couplings are only to be used where unavoidable, and shall be fitted with a sliced coupling as a lock-nut.

Conduit is to be run on approved spaced saddles rigidly secured to the walls.

Alternatively, fittings, tees, boxes, couplings etc., are to be cut into the surface to allow the conduit to fit flush against the surface. Conduit is to be bedded into any wall irregularities to avoid gaps between the surface and the conduit.

Crossing of conduits is to be avoided; however, should it be necessary purpose-made metal boxes are to be provided at the junction. The finish of the boxes and positioning shall be in keeping with the general layout.

Where several conduits are installed side by side, they shall be evenly spaced and grouped under one purpose-made saddle.

Distribution boards, draw-boxes, industrial switches and socket outlets etc., shall be neatly recessed into the surface to avoid double sets.

In situations where there are no ceilings the conduits are to be run along the wall plates and the beams.

Painting of surface conduit shall match the colour of the adjacent wall finishes.

Only approved plugging materials such as aluminium inserts, fibre plugs, plastic plugs, etc.,

and round-head screws shall be used for fixing saddles, switches, socket outlets, etc., to walls, wood plugs and the plugging in joints in brick walls are not acceptable.

10 CONDUIT IN CONCRETE SLABS

In order not to delay building operations the Contractor must ensure that all conduits and other electrical equipment, which are to be cast in the concrete columns and slabs, are installed in good time.

The Contractor shall have a representative in attendance at all times when the casting of concrete takes place.

Draw-boxes, expansion joint boxes and round conduit boxes are to be provided where necessary. Sharp bends of any nature will not be allowed in concrete slabs.

Draw and/or inspection boxes shall be grouped under one common cover plate and must preferably be installed in passages or male toilets.

All boxes, etc., are to be securely fixed to the shuttering to prevent displacement when concrete is cast. The conduit shall be supported and secured at regular intervals and installed as close as possible to the neutral axis of concrete slabs and/or beams.

Before any concrete slabs are cast, all conduit droppers to switchboards shall be neatly spaced and rigidly fixed.

11 FLEXIBLE CONNECTIONS FOR CONNECTING UP OF STOVES, MACHINES, ETC.

Flexible tubing connections shall be of galvanised steel construction, and in damp situations of the plastic sheathed galvanised steel type. Other types may only be used subject to the prior approval of the Engineer's site electrical representative.

Connectors for coupling onto the flexible tubing shall be of the gland or screw-in types, manufactured of either brass or cadmium or zinc plated mild steel, and the connectors after having been fixed onto the tubing, shall be durable and mechanically sound.
Aluminium and zinc alloy connectors will not be acceptable.

12 WIRING:

Except where otherwise specified in Part 2 of this specification, wiring shall be carried out in conduit throughout. Only one circuit per conduit will be permitted.

No wiring shall be drawn into conduit until the conduit installation has been completed and all conduit ends provided with bushes. All conduit to be clear of moisture and debris before wiring is commenced. Unless otherwise specified in Part 2 of this specification or indicated on the service drawings, the wiring of the installation shall be carried out in accordance with the "Wiring Code". Further to the requirements concerning the installation of earth conductors to certain light points as set out in the "Wiring Code", it is a specific requirement of this document that where plain-end

Metallic conduit or non-metallic conduit has been used, earth conductors must be provided and drawn into the conduit with the main conductors to all points, including all luminaires and switches throughout the installation.

Wiring for lighting circuits is to be carried out with 2,5mm² conductors and a 2,5mm² earth conductor. For socket outlet circuits the wiring shall comprise 4mm² conductors and a 2,5mm² earth conductor. In certain instances, as will be directed in Part 2 of this

specification, the sizes of the aforementioned conductors may be increased for specified circuits. Sizes of conductors to be drawn into conduit in all other instances, such as feeders to distribution boards, power points etc., shall be as specified elsewhere in this specification or indicated on the drawings. Sizes of conductors not specified must be determined in accordance with the "Wiring Code".

The loop-in system shall be followed throughout, and no joints of any description will be permitted.

The wiring shall be done in PVC insulated 600/1000 V grade cable to SABS 150.

Where cable ends connect onto switches, luminaires etc., the end strands must be neatly and tightly twisted together and firmly secured. Cutting away of wire strands of any cable will not be allowed.

13 SWITCHES AND SOCKET OUTLETS

All switches and switch-socket outlet combination units shall conform to the Engineer Quality Specifications which form part of this specification.

No other than 16A 3 pin sockets are to be used, unless other special purpose types are distinctly specified or shown on the drawings.

All light switches shall be installed at 1,4m above finished floor level and all socket outlets as directed in the Schedule of Fittings which forms part of this specification or alternatively the height of socket outlets may be indicated on the drawings.

14 SWITCHGEAR

Switchgear, which includes circuit breakers, iron-clad switches, interlocked switch-socket outlet units, contactors, time switches, etc., is to be in accordance with the Engineering Quality Specifications which form part of this specification and shall be equal and similar in quality to such brands as may be specified.

For uniform appearance of switchboards, only one approved make of each of the different classes of switchgear mentioned in the Quality Specifications shall be used throughout the installations.

15 SWITCHBOARDS

All boards shall be in accordance with the types as specified, be constructed according to the detail or type drawings and must be approved by the Engineer before installation.

In all instances where provision is to be made on boards for the supply authority's main switch and/or metering equipment the contractor must ensure that all requirements of the authorities concerned in this respect are met.

Any construction or standard type aboard proposed as an alternative to that specified, must have the prior approval of the Engineer.

All bus-bars, wiring, terminals, etc., are to be adequately insulated and all wiring is to enter the switchgear from the back of the board. The switchgear shall be mounted within the boards to give a flush front panel. Cable and boxes and other ancillary equipment must be provided where required.

Clearly engraved labels are to be mounted on or below every switch. The working of the labels in English is to be according to the lay-out drawings or as directed by the Engineer's representative and must be confirmed on site. Flush mounted boards to be installed with

the top of the board 2,0m above the finished floor level.

16 WORKMANSHIP AND STAFF

Except in the case of electrical installations supplied by a single phase electricity supply at the point of supply, an accredited person shall exercise general control over all electrical installation work being carried out.

The workmanship shall be of the highest grade and to the satisfaction of the Engineer. All inferior work shall, on indication by the Engineer's inspecting officers, immediately be removed and rectified by and at the expense of the Contractor.

17 CERTIFICATE OF COMPLIANCE

On completion of the service, a certificate of compliance must be issued to the Engineer's Representative/Agent in terms of the Occupational Health and Safety Act, 1993 (Act 85 of 1993).

18 EARTHING OF INSTALLATION

Main Earthing

The type of main earthing must be as required by the supply authority if other than the Specialist, and in any event as directed by the electrical engineer, who may require additional earthing to meet test standards.

Where required an earth mat shall be provided, the minimum size, unless otherwise specified, being 1,0m x 1,0m and consisting of 4mm diameter hard-drawn bare copper wires at 250mm centres, brazed at all intersections.

Alternatively, or additionally earth rods or trench earths may be required as specified or directed by the Engineer's authorised representative.

Installations shall be effectively earthed in accordance with the "Wiring Code" and to the requirements of the supply authority. All earth conductors shall be stranded copper with or without green PVC installation.

Connection from the main earth bar on the main board must be made to the cold water main, the incoming service earth conductor, if any and the earth mat or other local

electrode by means of 12mm x 1,60 mm solid copper strapping or 16 mm² stranded (not solid) bare copper wire or such conductor as the Engineer's representative may direct. Main earth copper strapping where installed below 3m from ground level, must be run in 20 mm diameter conduit securely fixed to the walls.

All other hot and cold water pipes shall be connected with 12mm x 0,8mm perforated for solid copper strapping (not conductors) to the nearest switchboard. The strapping shall be fixed to the pipework with brass nuts and bolts and against walls with brass screws at 150 mm centres. In all cases where metal water pipes, down pipes, flues, etc., are positioned within 1,6m of switchboards an earth connection consisting of copper strapping shall be installed between the pipework and the board. In vertical building ducts accommodating both metal water pipes and electrical cables, all the pipes shall be earthed at each distribution board.

Roofs, gutters and down pipes

Where service connections consist of overhead conductors, all metal parts of roofs, gutters and down pipes shall be earthed. One bare 10mm² copper conductor shall be installed over the full length of the ceiling void, fixed to the top purlin and connected to the main earth conductor and each switchboard. The roof and gutters shall be connected at 15m

intervals to this conductor by means of 12mm X 0,8mm copper strapping (not conductors) and galvanised bolts and nuts. Self-tapping screws are not acceptable. Where service connections consist of underground supplies, the above requirements are not applicable.

Sub-distribution boards

A separate earth connection shall be supplied between the earth bus-bar in each sub-distribution board and the earth bus-bar in the Main Switchboard.

These connections shall consist of a bare or insulated stranded copper conductor installed along the same routes as the supply cables or in the same conduit as the supply conductors. Alternatively armoured cables with earth continuity conductors included in the armouring may be utilised where specified or approved.

Sub-circuits

The earth conductors of all sub-circuits shall be connected to the earth bus-bar in the supply board in accordance with SABS 0142.

Ring Mains

Common earth conductors may be used where various circuits are installed in the same wire way in accordance with SABS 0142. In such instances the sizes of earth conductors shall be equivalent to that of the largest current carrying conductor installed in the wire way, alternatively the size of the conductor shall be as directed by the Engineer. Earth conductors for individual circuits branching from the ring main shall be connected to the common earth conductor with T-ferrules or soldered. The common earth shall not be broken.

Non-metallic Conduit

Where non-metallic conduit is specified or allowed, the installation shall comply with the Engineer's standard quality specification for "conduit and conduit accessories".

Standard copper earth conductors shall be installed in the conduits and fixed securely to all metal appliances and equipment, including metal switch boxes, socket-outlet boxes, draw-boxes, switchboards, luminaires, etc. The securing of earth conductors by means of self-threading screws will not be permitted.

Flexible Conduit

An earth conductor shall be installed in all non-metal flexible conduit. This earth conductor shall not be installed externally to the flexible conduit but within the conduit with the other conductors. The earth conductor shall be connected to the earth terminals at both ends of the circuit.

Connection

Under no circumstances shall any connection points, bolts, screws, etc., used for earthing be utilised for any other purpose. It will be the responsibility of the Contractor to supply and fit earth terminals or clamps on equipment and materials that must be earthed where these are not provided.

Unless earth conductors are connected to proper terminals, the end shall be tinned and lugged.

19 MOUNTING AND POSITIONING OF LUMINAIRES

The Contractor is to note that in the case of board and acoustic tile ceilings, i.e. as

opposed to concrete slabs, close co-operation with the building contractor is necessary to ensure that as far as possible the luminaires are symmetrically positioned with regard to the ceiling pattern.

The lay-out of the luminaires as indicated on the drawings must be adhered to as far as possible and must be confirmed with the Engineer's representative.

Fluorescent luminaires installed against concrete ceilings shall be screwed to the outlet boxes and in addition 2 x 6mm expansion or other approved type fixing bolts are to be provided. The bolts are to be $\frac{3}{4}$ of the length of the luminaires apart.

Fluorescent luminaires to be mounted on board ceilings shall be secured by means of two 40mm x No. 10 round head screws and washers. The luminaires shall also be bonded to the circuit conduit by means of locknuts and brass bushes. The fixing screws are to be placed $\frac{3}{4}$ of the length of the fitting apart.

Earth conductors must be drawn in with the circuit wiring and connected to the earthing terminal of all fluorescent luminaires as well as other luminaires exposed to the weather in accordance with the "Wiring Code".

Incandescent luminaires are to be screwed directly to outlet boxes in concrete slabs. Against board ceilings the luminaires shall be secured to the blanding or joists by means of two 40mm x No. 8 round head screws.

PART 2

DETAILED SPECIFICATION

ELECTRICAL INSTALLATIONS

DETAIL SPECIFICATION

PART 2

TABLE OF CONTENTS

CLAUSE	DESCRIPTION	PAGE
1	CABLE SLEEVE PIPES	14
2	NOTICES	14
3	ELECTRICAL EQUIPMENT	14
4	DRAWINGS	14
5	BALANCING OF LOAD	14
6	SERVICE CONDITIONS	14
7	SWITCHES AND SOCKET OUTLETS	14
8	LIGHT FITTINGS AND LAMPS	14
9	EARTHING AND BONDING	15
10	MAINTENANCE OF ELECTRICAL SUPPLY	15
11	EXTENT OF WORK	15
12	SUPPLY AND CONNECTION	15
13	CONDUIT AND WIRING	15-16
14	POWER POINTS	15
15	CABLES	16-19
16	DISTRIBUTION BOARDS	19
17	SCHEDULE OF LIGHT FITTINGS	19
18	SCHEDULE OF DISTRIBUTION BOARDS	19

DETAIL SPECIFICATION**1 CABLE SLEEVE PIPES**

Where cables cross under roadways, other services and where cables enter buildings, the cables shall be installed in asbestos-cement pipes, earthenware or high density polyethylene pipes.

The ends of all sleeves shall be sealed with a non-hardening watertight compound after the installation of cables. All sleeves intended for future use shall likewise be sealed.

2 NOTICES

The tenderer shall issue all notices and make the necessary arrangements with Supply Authorities, the Postmaster-General, S.A. Transport Services, Provincial or National Road Authorities and other authorities as may be required with respect to the installation.

3 ELECTRICAL EQUIPMENT

All equipment and fittings supplied must be in accordance with the attached quality specification (Part 3 of this document), suitable for the relevant supply voltage, and frequency and must be approved by the Engineer's representative.

4 DRAWINGS

The drawings generally show the scope and extent of the proposed work and shall not be held as showing every minute detail of the work to be executed.

The position of power points, switches and light points that may be influenced by built-in furniture must be established on site, prior to these items being built in.

5 BALANCING OF LOAD

The Contractor is required to balance the load as equally as possible over the multiphase supply.

6 SERVICE CONDITIONS

All plant shall be designed for the climatic conditions appertaining to the service.

7 SWITCHES AND SOCKET OUTLETS

The installation of switches and socket outlets must conform to clause 13 of Part 1 of this specification.

8 LIGHT FITTINGS AND LAMPS

The installation and mounting of luminaires must conform with clause 19 of Part 1 of this specification.

All fittings to be supplied by the Contractor shall have the approval of the Engineer illumination lamps shall bear the approved mark of the S.A.B.S. and shall have the British light centre length.

The light fittings must be of the type specified in the Schedule of Light Fittings.

9 EARTHING AND BONDING

The tenderer will be responsible for all earthing and bonding of the building and installation. The earthing and bonding is to be carried out strictly as described in clause 18 of Part 1 of this specification and to the satisfaction of the Engineer's representative.

10 MAINTENANCE OF ELECTRICAL SUPPLY

All interruptions of the electrical supply that may be necessary for the execution of the work, will be subject to prior arrangement between the Contractor and the user Engineer and the Engineer's representative.

11 EXTENT OF WORK

The work covered by this contract comprises the complete electrical & mechanical installations, in working order, as shown on the drawings and as per this specification, including the supply and installation of all fittings and also the installation of such equipment supplied by the Engineer.

12 SUPPLY AND CONNECTION

The supply will be at 400/220 Volt 50Hz.

The Contractor must arrange in good time with the local Authority for the low tension meter point and submit the account to the Engineer's Regional Office for payment.

The Contractor will be responsible for the supply and installation of the supply cable (from the supply authority's supply point) to the main low tension distribution kiosk (MAIN-KIOSK). The size and length of the cable is listed in the Schedule of Cables and provisionally measured in the Bills of Quantities.

13. CONDUIT AND WIRING

Conduit and conduit accessories shall be black enameled/galvanized screwed conduit or black enameled/galvanized plain end conduit in accordance with LATEST SABS 162, 763 and 1007 respectively.

All conduit, regardless of the system employed, shall be installed strictly as described in the applicable paragraphs of clauses 4 to 8 of Part 1 of the specification. Wiring of the installation shall be carried out as directed in clause 9 part 1 of this specification.

Where plain end conduit is offered all switches and light fittings must be supplied with a permanent earth terminal for the connection of the earth wire.

Lugs held by switch fixing screws or self-tapping screws will not be acceptable.

13.1 TELEPHONE, DATA, ACCESS CONTROL AND CCTV SYSTEM INSTALLATION

Tenderers shall allow for the supply, delivery and installation of all telephone, data, access control and CCTV systems conduits, draw boxes, outlets, draw-wires, etc. as specified and as indicated on the drawings.

Draw-wires

All conduits, sleeves, etc. required for the telephone, data, access control and CCTV systems installation shall be fitted with galvanised steel draw-wires.

Outlets/Data

All telephone, data, access control and CCTV system outlets shown shall consist of 100 x 100 x 50mm boxes, complete with cover.

13.2 POWER TRUNKING

The Contractor shall be responsible for the supply and installation of all power trunking complete with corner pieces, end pieces, junction pieces, supply conduits, cover plates and power outlets as specified and indicated on the drawings.

The power trunking must comply with SABS 1197. The Contractor must ensure that the power trunking is installed to satisfaction of the Engineer's representative before commencing with the wiring of the power trunking.

14. POWER POINTS

Allow for the installation of power points and equipment as listed in the schedule, indicated on the drawings.

14.1 Geysers

The electrical contractor must electrically connect all geysers as specified and shown on the drawings OR as instructed on site by the Electrical Engineer.

15. CABLES

The Contractor shall supply and completely install all distribution cables as indicated on the drawings, and listed in the Schedule of Cables.

The storage, transportation, handling and laying of the cables shall be according to first class practice, and the contractor shall have adequate and suitable equipment and labour to ensure that no damage is done to cables during such operations.

The cable-trenches shall be excavated to a minimum depth of **0,7m** deep below ground level and shall be 450mm wide for one to three cables, and the width shall be increased where more than three cables are laid together so that the cables may be placed at least two cable diameters apart throughout the run. The bottom of the trench shall be level and clean and the bottom and sides free from rocks or stones liable to cause damage to the cable.

The Contractor must take all necessary precautions to prevent the trenching work being in any way a hazard to the personnel and public and to safeguard all structures, roads, sewage works or other property on the site from any risk of subsidence and damage.

In the trenches the cables shall be laid on a 75mm thick bed of earth and be covered with a 150 mm layer of earth before the trench is filled in.

All joints in underground cables and terminations shall be made either by means of compound filled boxes according to the best established practice by competent cable jointers using first class materials or by means of approved epoxy-resin pressure type jointing kits such as "Scotchcast". Epoxy-resin joints must be made entirely in accordance with the manufacturer's instructions and with materials stipulated in such instructions. Low tension PVCA cables are to be made off with sealing glands and materials designed for this purpose which must be of an approved make. Where cables are cut and not immediately made off, the ends are to be sealed without delay.

The laying of cables shall not be commenced until the trenches have been inspected and approved. The cable shall be removed from the drum in such a way that no twisting,

tension or mechanical damage is caused and must be adequately supported at intervals during the whole operation. Particular care must be exercised where it is necessary to draw cables through pipes and ducts to avoid abrasion, elongation or distortion of any kind. The ends of such pipes and ducts shall be sealed to approval after drawing in of the cables.

Backfilling (after bedding) of the trenches is to be carried out with a proper grading of the material to ensure settling without voids, and the material is to be tamped down after the addition of every 150mm. The surface is to be made good as required.

On each completed section of the laid and jointed cable, the insulation resistance shall be tested to approval with an approved "Megger" type instrument of not less than 500 V for low tension cables.

Earth continuity conductors are to be run with all underground cables constituting part of a low tension distribution system. Such continuity conductors are to be stranded bare copper of a cross-sectional area equal to at least half that of one live conductor of the cable, but shall not be less than

4mm² or more than 70mm². A single earth wire may be used as earth continuity conductor for two or more cables run together, branch earth wires being brazed on where required.

15.1 LAYING, JOINTING AND MAKING OFF OF ELECTRICAL CABLES

1. The use of the term "Inspector", includes the engineer or inspector of the Engineer or an empowered person of the concerned supervising consulting engineer's firm.
2. No cable is to be laid before the cable trench is approved and the soil qualification of the excavation is agreed upon by the Contractor and inspector.
3. After the cable has been laid and before the cable trench is back-filled the inspector must ensure that the cable is properly bedded and that there is no undesirable material included in the bedding layer.
4. All cable jointing and the making off of the cables must only be carried out by qualified experienced cable jointers. Helpers of the jointers may not saw, strip, cut, solder, etc. The cable and other work undertaken by them must be carried out under the strict and constant supervision of the jointer.
5. Before the Contractor allows the jointer to commence with the jointing work or making off of the cable (making off is recognised as half a joint) he must take care and ensure:
 - 5.1 That he has adequate and suitable material available to complete the joint properly and efficiently. Special attention must be given to ensure the cable ferrules and cable lugs are of tinned copper and of sufficient size. The length of the jointing lugs must be at least six times the diameter of the conductor,
 - 5.2 That the joint pit is dry and that all loose stones and material are removed,
 - 5.3 That the walls and banks of the joint pit are reasonable firm and free from loose material which can fall into the pit,
 - 5.4 That the necessary coffer-dams or retaining walls are made to stop the flow of water into the joint pit,
 - 5.5 That the joint pit is provided with suitable groundsheets so that the jointing

work is carried out in clean conditions,

- 5.6 That the necessary tents or sails are installed over the joint pit to effectively avert unexpected rainfall and that sufficient light or lighting is provided,
- 5.7 That the necessary means are available to efficiently seal the jointing or cable end when an unexpected storm or cloudburst occurs, regardless of how far the work has progressed,
- 5.8 That the cables and other materials are dry, undamaged and in all respects are suitable for the joint work or making off,
- 5.9 that the heating of cable oil, cable compound, plumbers metal and solder is arranged that they are at the correct temperature when required so that the cable is not unnecessarily exposed to the atmosphere and consequently the ingress of moisture (care must be taken of overheating)

Flow temperatures of cable oil and compound must be determined with suitable thermometers. Cable oil and compound must not be heated to exceed the temperatures given on the containers and precaution must be taken to ensure that the tin is not overheated in one position. The whole mass must be evenly and proportionally heated.

(Temperatures of solder and plumbers metal may be tested with brown paper (testing time: 3 seconds). The paper must colour slightly - not black or burnt).

- 6. Before the paper insulated cables are joined, they must be tested for the presence of moisture by the cable jointers test. This consists of the insertion of a piece of unhandled insulated impregnated paper tape in warm cable oil heated to a temperature of $130 \pm 5^{\circ}\text{C}$. Froth on the surface of the oil is an indication that moisture is present in the impregnated insulation and the amount of the froth gives an indication of the moisture present.
- 7. If the cable contains moisture or is found to be otherwise unsuitable for jointing or making of the inspector is to be notified immediately and he will issue the necessary instruction to cope with the situation.
- 8. The joint or making off of paper insulated cables must not be commenced during rainy weather.
- 9. Once a joint is in progress the jointer must proceed with the joint until it is complete and before he leaves the site.
- 10. The jointer must ensure that the material and his tools are dry at all times, reasonably clean and absolutely free from soil.
- 11. Relating to the jointing of the cable the following requirements apply:
 - 11.1 All jointing must be carried out in accordance with recognised and tried techniques and comply strictly with the instructions given by the supplier of the jointing kit.
 - 11.2 The cables must be twisted by hand so that the cores can be joined according to the core numbers. If necessary the cable is to be exposed for a short distance to accomplish this. Under no circumstances may the cores in a joint be crossed so as to enable cores to be joined according to the core numbers. If it is not possible to twist the cables so that the preceding requirements can be met, then cores are to be joined in the normal way without any consideration of the core numbers.

- 11.3 Normally the cables will have profile conductors. The conductors shall be pinched with gas pliers to form a circular section, bound with binding wire so that they do not spread, and then tinned before jointing.
- 11.4 Jointing ferrules, the length of which are at least 6 times the diameter of the conductors, must be slid over the conductor ends to be joined and pinched tightly. Then they are soldered by means of the ladle process whilst being pinched further closed.
Use resin only as a flux. The slot opening in the ferrule must be completely filled, including all depressions.
- Remove all superfluous metal with a cloth dipped in tallow. Work during the soldering process must be from top to bottom. Rub the ferrule smooth and clean with aluminum oxide tape after it has cooled down to ensure that there are not any sharp points or edges.
- NB:** The spaces between the conductor strands must be completely filled by soldering process and must be carried out quick enough to prevent the paper insulation from burning or drying out unnecessarily.
- 11.5 After the ferrules have been rubbed smooth and clean, they and the exposed cores must be treated with hot cable oil (110°C) to remove all dust and moisture. These parts are to be thoroughly basted with the oil.
- 11.6 The jointer must take care that his hands are dry and clean before the joint is insulated. Also the insulating tape which is to be used must first be immersed in warm cable oil (110°C) for a sufficient period to ensure that no moisture is present.
- 11.7 After the individual cores have been installed they must be well basted with hot cable oil and again after the applicable separator and/or belt insulation tape is applied before the lead joint sleeve is placed in position.
- 11.8 The lead joint sleeve must be thoroughly cleaned and prepared before it is placed on the cable and must be kept clean during the whole jointing process. Seal the filling apertures of the sleeve with tape until the sleeve is ready for compound filling.
- 11.9 The plumbing joints employed to solder the joint sleeve to the cable sheath, must be cooled off with tallow and the joint sleeve is to be filled with compound while it is still warm. Top up continuously until the joint is completely filled to compensate for the compound shrinkage.
- 11.10 The outer joint box must be clean and free from corrosion. After it has been placed in position it must be slightly heated before being filled with compound. Top up until completely full.
12. As far as cable end boxes are concerned the requirements as set out above are valid where applicable.

16. DISTRIBUTION BOARDS

In addition to clause 14 and clause 15 of Part 1 of this specification the following shall also be applicable to switchboards required for this service.

The electrical contractor shall supply and install the distribution boards as indicated on the drawings and listed in the distribution Board Schedule. All distribution boards shall comply with the quality specification in Part 3 of this specification, and be approved by the Engineer's representative.

17. SCHEDULE OF LIGHT FITINGS

The light fittings and accessories are to be according to the quality specifications in Part 3 and shall be approved by the Engineer / Engineer representative.

18. SCHEDULE OF DISTRIBUTION BOARDS

Refer to single line diagram for Distribution Kiosk drawing no VL - C - BE - TCS - TDW - 003/1/1 - A.

The front panels of normal supply sections shall be painted in distinctive colours as follows:
Normal supply : Electric Orange, IP65 and powder coated.

Indicated is the probable fault level rating (kA) of the busbars.

Erupting capacity	5kA
--------------------------	-----

PART 3

QUALITY SPECIFICATION FOR MATERIAL

AND

ELECTRICAL INSTALLATIONS

QUALITY SPECIFICATION FOR MATERIAL AND EQUIPMENT OF ELECTRICAL RENOVATION AND NEW INSTALLATIONS

PART 3

TABLE OF CONTENTS

CLAUSE	DESCRIPTION	PAGE
1	CONDUIT AND CONDUIT ACCESSORIES	23-25
2	PVC- INSULATED CABLES –600/1000V GRADE	25-26
3	GLANDS FOR PVC INSULATED CABLES	26-27
4	LIGHT SWITCHES	27-28
5	UNSWITCHED AND SWITCHED SOCKET OUTLETS	29-29
6	TUBULAR FLUORESCENT LAMPS LUMINAIRES FOR INTERIOR APPLICATIONS	29-34
7	AIR CONDITION UNITS	34
8	EARTHING ELECTRODES	34-35
9	SWITCHBOARDS (UP TO 1KV)	35-48
10	MOULDED-CASE CIRCUIT- BREAKERS	48
11	EARTH LEAKAGE RELAYS	49
12	MICRO-GAP SWITCHES	49
13	INDICATOR LIGHTS	49-50
14	TRIPLE POLE ON LOAD ISOLATORS	50
15	TIME SWITCHES	50-51
16	CONTACTORS	51-52
17	STANDARD PAINT SPECIFICATION	52-53

**SPECIFICATION FOR ELECTRICAL INSTALLATIONS
PART 3**

QUALITY SPECIFICATION FOR MATERIAL AND EQUIPMENT OF ELECTRICAL INSTALLATIONS:

1. **CONDUIT AND ACCESSORIES.**

The type of conduit and accessories required for the service, i.e. whether the conduit and accessories shall be of the screwed type, plain-end type or of the non-metallic type and whether metallic conduit shall be black enamelled or galvanised, is specified in Part 2 of this specification. Unless other methods of installation are specified for certain circuits, the installation shall be in conduit throughout. NO OPEN WIRING IN ROOF SPACES OR ELSEWHERE WILL BE PERMITTED.

The conduit and conduit accessories shall comply fully with the applicable SABS specifications as set out below and the conduit shall bear the mark of approval of the South African Bureau of Standards.

- (a) Screwed metallic conduit and accessories: SABS 1065 parts 1 and 2.
- (b) Plain-end metallic conduit and accessories: SABS 1065 Parts 1 and 2.
- (c) Non-metallic conduit and accessories: SABS 950

All conduit fittings except couplings shall be of the inspection type. Where cast metal conduit accessories are used, these shall be of malleable iron. Zinc base fittings will not be allowed.

Bushes used for metallic conduit shall be brass and shall be provided in addition to lock nuts at all points where the conduit terminates at switchboards, switch-boxes, draw-boxes, etc.

Draw-boxes are to be provided in accordance with the "Wiring Code" and wherever necessary to facilitate easy wiring.

For light and socket outlet circuits, the conduit used shall have an external diameter of 20mm. In all other instances the sizes of conduit shall be in accordance with the "Wiring Code" for the specified number and size of conductors, unless otherwise directed in part 2 of this specification or indicated on the drawings.

Only one manufacture of conduit and conduit accessories will be permitted throughout the installation.

Running joints in screwed conduit are to be avoided as far as possible and all conduit systems shall be set or bent to the required angles. The use of normal bends must be kept to a minimum with exception of larger diameter conduits where the use of such bends is essential.

All metallic conduits shall be manufactured of mild steel with a minimum thickness of 1,2mm for plain-end conduit and 1.6mm in respect of screwed conduit.

NOTE

Under no circumstances will conduit having a wall thickness of less than 1,6mm be allowed in screeding laid on top of concrete slabs.

Bending and setting of conduit must be done with special bending apparatus manufactured for the purpose and which are obtainable from the manufacturers of the conduit systems. Damage to conduit resulting from the use of incorrect bending apparatus

or methods applied must on indication by the Engineer's inspectorate staff, be completely removed and rectified and any wiring already drawn into such damaged conduits must be completely renewed at the contractor's expense.

Conduit and conduit accessories used for flame-proof or explosion proof installations and for the suspension of luminaires as well as all load bearing conduit shall in all instances be of the metallic screwed type.

All conduit and accessories used in areas within 50km of the coast shall be galvanised to SABS 763.

Tenderers must ensure that general approval of the proposed conduit system to be used is obtained from the local electricity supply authority prior to the submission of their tender. Under no circumstances will consideration be given by the Engineer to any claim submitted by the contractor which may result from a lack of knowledge in regard to the supply authority's requirements.

1.2 **CONDUIT IN ROOF SPACES.**

Conduit in roof spaces shall be installed parallel or at right angles to the roof members and shall be secured at intervals not exceeding 1,5m by means of saddles screwed to the roof timbers.

Nail or crumpets will not be allowed.

Where non-metallic conduit has been specified for a particular service, the conduit shall be supported and fixed with saddles with a maximum spacing of 450mm throughout the installation. The contractor shall supply and install all additional supporting timbers in the roof space as required.

Under flat roofs, in false ceilings or where there is less than 0,9m of clearance, or should the ceilings be insulated with glass wool or other insulating material, the conduit shall be installed in such a manner as to allow for all wiring to be executed from below the ceilings.

Conduit runs from distribution boards shall, where possible terminate in fabricated sheet steel draw-boxes installed directly above or in close proximity to the boards.

1.3 **SURFACE MOUNTED CONDUIT.**

Wherever possible, the conduit installation is to be concealed in the building work; however, where unavoidable or otherwise specified under Part 2 of the specification, conduit installed on the surface must be plumbed or levelled and only straight lengths shall be used.

The use of inspection bends is to be avoided and instead the conduit shall be set uniformly and inspection coupling used where necessary.

No threads will be permitted to show when the conduit installation is complete, except where running couplings have been employed.

Running couplings are only to be used where unavoidable, and shall be fitted with a sliced couplings as a locknut.

Conduit is to be run on approved spaced saddles rigidly secured to the walls.

Alternatively, fittings, tees, boxes, couplings etc., are to be cut into the surface to allow the conduit to fit flush against the surface. Conduit is to be bedded into any wall irregularities to avoid gaps between the surface and the conduit.

Crossing of conduits is to be avoided, however, should it be necessary purpose-made metal boxes are to be provided at the junction. The finish of the boxes and positioning shall be keeping with the general layout.

Where several conduits are installed side by side, they shall be evenly spaced and grouped under one purpose-made saddle.

Distribution boards, draw-boxes, industrial switches and socket outlets etc., shall be neatly recessed into the surface to avoid double sets.

In situations where there are no ceilings the conduits are to be run along the wall plates and tie beams.

In buildings where building operations are to be carried out, all surface conduit will be painted by the building contractor.

In all other instances the electrical contractor shall allow for painting of surface conduit with two coats of good quality enamel paint, and the colour shall match the surrounding building finish.

Only approved plugging materials such as aluminium inserts, fibre plugs, plastic plugs, etc., and round head screws shall be used for fixing saddles, switches, socket outlets, etc., to walls, wood plugs and the plugging in joints in brick walls are not acceptable.

1.4 **CONDUIT IN CONCRETE SLABS.**

In order not to delay building operations the contractor must ensure that all conduits and other electrical equipment, which are to be cast in the concrete columns and slabs, are installed in good time.

The contractor shall have a representative in attendance at all times when the casting of concrete takes place.

Draw-boxes, expansion joint boxes and round conduit boxes are to be provided where necessary. Sharp bends of any nature will not be allowed in concrete slabs.

Draw and/or inspection boxes shall be grouped under one common cover plate, and must preferably be installed in passages or male toilets.

All boxes, etc. are to be securely fixed to the shuttering to prevent displacement when concrete is cast. The conduit shall be supported and secured at regular intervals and installed as close as possible to the neutral axis of concrete slabs and/or beams.

Before any concrete slabs are cast, all conduit droppers to switchboards shall be neatly spaced and rigidly fixed.

2. **PVC-INSULATED CABLES - 600/1 000 V GRADE**

2.1 GENERAL

This section covers the requirements for PVC-insulated cables for general installations under normal environmental conditions.

2.2 CONSTRUCTION

2.2.1 Cables shall be manufactured in accordance with SABS 150, shall come only from fresh stocks, and shall be constructed as follows:

- (a) Unarmoured cables PVC-insulated/PVC-sheathed

(b)	Armoured cables	PVC-insulated/PVC-bedded/ armoured/black extruded PVC outer sheath
(c)	Single core cables	PVC-insulated/unsheathed

2.2.2 The conductors shall be of high conductivity annealed stranded copper and the cores may be shaped or circular.

2.2.3 The insulation shall be general purpose PVC, 600/1 000V Grade.

2.2.4 The bedding shall consist of a continuous impermeable sheath of PVC extruded to fit the core or cores closely and in the case of multi-core cables, to fill the interstices between the cores.

2.2.5 Where armouring is specified it shall consist of one layer of galvanised steel wire in the case of multi-core cables and nonmagnetic metallic wire in the case of single core cables. Aluminium strip or tape armouring is not acceptable.

2.2.6 Where specified, an earth continuity conductor shall be provided in the armouring in accordance with SABS 150.

2.3 PVC-SHEATHED ALUMINIUM-COVERED CABLES

2.3.1 Aluminium-covered cables shall comprise PVC-insulated copper conductors protected by an aluminium foil tape screen and a PVC sheath.

2.3.2 Cable ends shall be made off with compression glands fitted with a neoprene ring to seal the end.

2.3.3 Aluminium sheathed cable shall be installed on surface only using matching saddles installed at suitable intervals to prevent sagging.

2.3.4 Where exposed to sunlight, the cable shall have a stabilised black outer sheath.

2.4 LENGTHS

Cable shall be manufactured and supplied in one length to the lengths specified unless these lengths exceed a standard drum length in which case a ruling shall be obtained from the Engineer.

2.5 TESTS

At the option of the Engineer, acceptance tests shall be carried out on production runs of the cable in accordance with SABS 150.

3. GLANDS FOR PVC-INSULATED CABLES

3.1 Glands to be used for terminating PVC/PVC/SWA/PVC cables shall be of the adjustable type.

3.2 Glands shall be suitable for general purpose 600/1 000 V Grade cable with steel armouring.

3.3 The glands shall be made of nickel-plated cadmium plated or in coastal area bronze or brass.

3.4 The glands shall consist of a barrel carrying a cone bush screwed into one end and a nickel-plated brass nipple carrying a nickel-plated brass or a heavy galvanised steel

locknut screwed into the other end. The galvanising shall comply with SABS 763.

- 3.5 Non-watertight glands must be easily converted to watertight glands by means of a waterproofing shroud and inner seal kit. On the cable entry side of the barrel a concave groove shall be provided to accommodate the top rim of the waterproofing shroud.
- 3.6 The shrouds shall be made of non-deteriorating neoprene or other synthetic rubber, and shall be resistant to water, oil and sunlight. The shrouds shall fit tightly around the glands and cable.
- 3.7 Glands shall be provided with ISO threads and shall be suitable for the specified cable sizes.
- 3.8 Flameproof glands shall comply with SABS 808, Groups 1, 2a and 2b.
- 3.9 Suitable accessories shall be provided with glands to be used on ECC armoured cables to facilitate a bolted lug connection of the earth continuity conductors. Grooves cut into the barrel or cone bush to accommodate the earth continuity conductors are not acceptable.
- 3.10 For unarmoured cables the cone bush and compression ring of the gland shall be replaced with a synthetic rubber compression bush and ring to provide the required grip on the outer sheath of the cable.

4. LIGHT SWITCHES

4.1 GENERAL

This section covers the requirements for switches for use in general installations under normal environmental conditions.

4.2. FLUSH AND SURFACE MOUNTED SWITCHES

- 4.2.1 All switches shall be suitable for mounting in 100 x 50 x 50mm boxes shall comply with SABS 163 and shall bear the SABS mark.
- 4.2.2 Switches shall be of tumbler operated microgap type rated at 16A, 220/250V.
- 4.2.3 Switches shall have protected terminals for safe wiring.
- 4.2.4 Contacts shall be of silver material.
- 4.2.5 On multi-lever switches, it shall be possible to individually change any of its switches.
- 4.2.6 The yoke strap shall be slotted to allow for easy alignment.
- 4.2.7 The covers of surface mounted switches shall have toggle protectors.
- 4.2.8 Where light switches are installed in partitions, they shall, where possible, be of the special narrow type intended for installation into the mullions.

4.3. WATERTIGHT SWITCHES

- 4.3.1 Watertight switches shall be of the microgap type suitable for surface mounting and shall bear the SABS mark.
- 4.3.2 The housing shall be of galvanised cast iron or die cast aluminium with watertight cover plate and toggle.
- 4.3.3 The switch shall have a porcelain base and a quick acting spring mechanism and shall be

rated at 16A, 220/250V.

4.3.4 The ON/OFF position shall be clearly marked on the switch housing.

4. CEILING SWITCHES

4.4.1 Ceiling switches shall be rated at 10A, 220/250V and shall be suitable for ceiling mounting on a round conduit box.

4.4.2 The switch shall be made of high impact strength nylon material.

4.4.3 Adequate space shall be provided within the unit for ease of wiring.

4.4.4 The switch colour shall be white and shall be fitted with a nylon cord 1,25m long.

4.5. COVER PLATES

4.5.1 Cover plates shall be finished in ivory coloured baked enamel, anodised bronze or aluminium unless otherwise specified.

4.5.2 Cover plates shall overlap the outlet to cover wall imperfections.

4.5.3 Cover plates shall comply with SABS 1084.

5. UNSWITCHED AND SWITCHED SOCKET-OUTLETS

5.1. GENERAL

This section covers the requirements for unswitched and switched socket-outlets for use in general installations under normal environmental conditions.

5.2. FLUSH AND SURFACE MOUNTED SWITCHED SOCKETS

5.2.1 All switched socket-outlets shall be suitable for mounting in 100 x 100 x 50mm or 100 x 50 x 50mm boxes, shall comply with SABS 164.

5.2.2 Switches shall be of the tumbler operated microgap type rated at 16A, 220/250V.

5.2.3 Terminals shall be enclosed for safe wiring.

5.2.4 Contacts shall be of silver material.

5.2.5 Safety shutters shall be provided on live and neutral openings.

5.2.6 The yoke strap shall be slotted to allow for easy alignment.

5.2.7 The covers of surface mounted switched socket shall have toggle protectors.

5.2.8 Miniature circuit-breakers shall be used in lieu of a switch where specified.

5.2.9 Where 13A flat pin switched socket-outlets are specified, these shall comply with BS 1363.

5.3. WATERTIGHT SWITCHED SOCKETS

5.3.1 The housing of watertight switched sockets shall be of galvanised cast iron or die cast aluminium with watertight machined joints.

- 5.3.2 The switch shall have a porcelain base and a quick-acting spring mechanism and shall be rated at 16A, 220/250V.
- 5.3.3 The ON/OFF positions shall be clearly marked on the switch housing.
- 5.3.4 The socket openings shall be rendered watertight by means of a gasketed cover plate which is screwed onto the body of the unit. The cover plate shall be secured to the body of the unit by means of a chain.

5.4. UNSWITCHED SOCKET-OUTLETS

- 5.4.1 Unswitched socket-outlets shall only be used in the case of 5A, 220/250V, 3-pin socket-outlets intended for the connection of recessed light fittings installed in false ceilings.
- 5.4.2 The socket-outlets shall have shuttered live and neutral openings.
- 5.4.3 The socket-outlets shall be suitable for installation in pre-punched wiring channels, deep round conduit boxes, 100 x 50 x 50mm or 100 x 100 x 50mm boxes.

5.5. THREE-PHASE SWITCHED SOCKET-OUTLETS

- 5.5.1 Three-phase switched socket-outlets shall have 5 pins, one for each phase, neutral and earth. The current rating shall be as specified in the Detail Technical Specification.
- 5.5.2 The units shall be interlocked to prevent switching on if the plug top is not installed.
- 5.5.3 The units shall be supplied complete with plug top.
- 5.5.4 The live terminals shall be shrouded and shall be completely safe when the plug top is removed.
- 5.5.5 Samples shall be submitted to the Engineer for approval prior to the installation.

5.6. SHAVER SOCKETS

Not part of this contract

6. TUBULAR FLUORESCENT LAMP LUMINAIRES FOR INTERIOR APPLICATIONS

6.2. GENERAL

- 6.2.1 To promote work creation in South Africa, the luminaire should preferably be manufactured within the Republic of South Africa and should have a local content of at least 50%.
- 6.2.2 If the luminaire offered is of foreign origin, full specifications on technical performance and quality must be submitted and full reasons shall be given why the unit had to be imported.
- 6.2.3 **A sample luminaire shall be provided for evaluation and approval by the Electrical Engineer prior to installation.**
- 6.2.4 Luminaires, associated equipment and control gear shall be new and unused and shall be supplied complete with lamps, control gear, diffusers, mounting brackets, etc. and shall be delivered to site in a protective covering.
- 6.2.5 Lamps shall be delivered separately.

6.3. STANDARDS

The following latest edition standard specifications of the South-African Bureau of Standards shall apply to this luminaire specification:

- | | | |
|--------|---|--|
| 6.3.1 | SABS 1119: | Interior luminaires for fluorescent lamps. |
| 6.3.2 | SABS 1250: | Capacitors for use with fluorescent and other discharge lamp ballasts. |
| 6.3.3 | SABS 890: | Ballast's for fluorescent lamps. |
| 6.3.4 | SABS 1464: | Safety of luminaires. |
| 6.3.5 | SABS 1479: | Glow starters for fluorescent lamps. |
| 6.3.6 | SABS IEC 400: | Lamp holders for tubular fluorescent lamps. |
| 6.3.7 | SABS 1041: | Tubular fluorescent lamps for general service. |
| 6.3.8 | SABS 1247: | Coatings applied by the powder-coating process. |
| 6.3.9 | SABS 783: | Baked enamels. |
| 6.3.10 | SABS 0142: | The wiring of Premises |
| 6.3.11 | Any standard referred to in the above specifications. | |

6.4. PHYSICAL AND ENVIRONMENTAL REQUIREMENTS

- 6.4.1 AREAS OF APPLICATION: The luminaires are intended for standard indoor use in buildings under the control of the Engineer of Public Works.
- 6.4.2 FIXING: The luminaires shall be suitable for mounting in or against ceilings as described in the project specification.
- 6.4.3 ENVIRONMENTAL: Unless otherwise specified in the detail specification the luminaires shall be suitable for operation in ambient temperatures between -10°C and +25°C.
- 6.4.4 SAFETY: The luminaire shall bear the SABS 1464 safety mark.
- i. NOISE: Noisy ballasts will not be accepted and shall be replaced at no cost to the Engineer. All ballasts shall comply with the requirements of the latest edition of SABS 890, Part 1.

6.5. GENERAL TECHNICAL REQUIREMENTS

6.5.1 GENERAL

- 6.5.1.1 Tubular fluorescent lamp luminaires shall comply fully with SABS 1119 and all amendments as well as the additional requirements of this specification. Luminaires shall bear the SABS mark, or at least have a SABS Certificate of Compliance.
- 6.5.1.2 The Engineer reserves the right to have samples of luminaires offered tested by the SABS for compliance with SABS 1119. If a sample luminaire is found not to comply with SABS 1119 the cost of such tests shall be borne by the Tenderer.

6.5.2 CONSTRUCTION

- 6.5.2.1 A luminaire shall consist of a ventilated body manufactured of cold rolled sheet steel not less than 0,8mm thick, suitably braced or stiffened to prevent distortion. The body shall be of sufficient strength for the mounting of the entire luminaire.
- 6.5.2.2 The luminaire shall be designed to accommodate the control gear, wiring, lamp holders and, where applicable, the diffuser and reflectors. It shall be possible to reach the control gear without disconnecting wiring or removing the luminaire.

6.5.2.3 Except for mounting holes and/or slots and the required openings in air-return luminaires, the back of the body channel shall be closed over the full length of the luminaire.

6.5.2.4 Suitable knockouts shall be provided in the rear of the luminaire body for wire entry.

6.5.2.5 All components, including screws, bolts and nuts utilised in the construction of the luminaire or fixing of its components, shall be corrosion proof. Cadmium plated or stainless steel materials are preferred.

6.5.3 INTERNAL WIRING

6.5.3.1 Luminaires shall be completely wired internally. Conductors shall be protected with grommets where they pass through holes in the body.

6.5.3.2 The wiring shall be totally metal enclosed to prevent any possible contact with live components while changing lamps.

6.5.3.3 The conductor insulation shall be rated to withstand the temperature inside the luminaire body without deterioration.

6.5.3.4 The wiring shall terminate on a suitable terminal block having screw down plates bearing on the wires. Terminals where screws bear down directly on wires will not be acceptable.

6.5.3.5 An earth terminal, welded to the luminaire body, shall be provided. To ensure good earth continuity the earth terminal shall not be spray painted. The earth conductor shall be connected to this terminal by means of a crimped lug.

6.5.4 LAMP HOLDERS

Lamp holders shall preferably be of the telescopic spring-loaded type. Where twist-lock type lamp holders are provided, the mounting of the holders shall be able to accommodate the tolerances experienced in the length of lamps and in the manufacture of luminaires.

6.5.5 CONTROL GEAR

6.5.5.1 The control gear, ballasts, capacitors and starters shall be designed and manufactured to suit the control circuitry adopted. All luminaires shall operate on a switch-start basis.

6.5.5.2 Ballasts shall comply with SABS 890 and SABS 891, suitable for operation on 220V to 250V, 50Hz supplies.

6.5.5.3 Ballasts shall further be suitable for the particular luminaire to ensure that the thermal limits specified in paragraph 3.5 of SABS 1119 are not exceeded.

6.5.5.4 Starters shall comply with SABS 1479 or with BS 3772 if it is not covered by SABS 1479. Starters with metal cans shall contain integral earthing facilities to earth the can upon insertion.

6.5.5.5 Starters shall be accessible from the outside of the luminaire, and the replacement of the starter shall not necessitate the removal of lamps.

6.5.6 CAPACITORS

Capacitors shall comply with SABS 1250. The power factor of each complete fitting shall be corrected to at least 0,85.

6.5.7 LAMPS

- 6.5.7.1 Fluorescent lamps shall be suitable for the control circuitry used. Lamps shall comply with SABS 1041.
- 6.5.7.2 If no colour is specified in the Detail Technical Specification, the light colour shall correspond to colour 2 (4 300K) of SABS 1041.
- 6.5.7.3 Lamps of the same colour (Cool White) shall be provided for an entire installation unless specified to the contrary.
- 6.5.7.4 There shall be no visible flicker in the lamps and lamps shall readily strike when switched on. Faulty lamps or ballasts shall be replaced at no cost to the Engineer.

6.6. PHOTOMETRIC DATA

Photometric data sheets of the luminaire as prepared by a laboratory that complies with SABS requirements, shall be submitted with the luminaire.

6.7. TECHNICAL INFORMATION

The Tenderer shall include full technical particulars regarding the luminaire offered with the tender.

6.8. CHANNEL LUMINAIRE

- 6.8.1 Channel luminaires shall consist of a ventilated, enclosed channel body with one or more lamps as specified in the project specification. The channel body shall house the ballast, capacitor, terminals and internal wiring.
- 6.8.2 Provision shall be made for the addition of reflector wings and/or diffusers.
- 6.8.3 Three sets of mounting slots and knock-outs suitable for mounting onto standard round conduit boxes and/or 20mm diameter conduit pendant rods, shall be provided in the rear of the channel, one in the centre and one approximately one sixth from each end.
- 6.8.4 A knockout suitable for a 20mm diameter conduit entry shall be provided at each end of the channel. The distance between the back of the luminaire and centre of the knockout shall be approximately 25mm.
- 6.8.5 The knockouts shall be positioned on the centre line of the channel.
- 6.8.6 The body channel shall incorporate a removable cover acting as a reflector, manufactured of cold rolled steel, not less than 0,8mm thick, designed and mounted to completely cover the interior of the body channel and its contents and extending over the full length of the luminaire up to the lamp holders.
- 6.8.7 The reflector shall be firmly held in position with a latching device consisting of knurled, coin slot, captive screws. Plastic, used as a spring mechanism, is not acceptable as a fixing device for reflectors. The action of the latching device shall not deteriorate due to use and/or ageing.

6.9. INDUSTRIAL LUMINAIRES

- 6.9.1 Industrial type luminaires shall consist of a basic channel luminaire fitted with detachable side reflectors.
- 6.9.2 The reflectors shall be manufactured of cold rolled steel, not less than 0,8mm thick.

- 6.9.3 The reflectors shall be designed to improve the downward light output ratio and decrease the upward light output ratio to a value of less than 2%.
- 6.10. DECORATIVE LUMINAIRES
- 6.10.1 Decorative luminaires shall incorporate an injection moulded prismatic acrylic diffuser or a high-grade optical reflector covering the entire reflecting surface of the luminaire.
- 6.10.2 The diffuser shall be hinged or easily removable for maintenance and lamp replacement. Optical reflectors shall be hinged.
- 6.10.3 Decorative luminaires with diffusers shall be constructed and so installed to prevent the ingress of dust and insects.
- 6.10.4 Highly polished reflectors shall be protected and carefully handled and to prevent fingerprints showing on the surface.
- 6.10.5 Surface mounted luminaires on suspended ceilings shall be arranged to suit the grid and shall fit tightly against the ceiling.
- 6.11. RECESSED LUMINAIRES
- 6.11.1 Recessed luminaires shall be suitable for mounting in the ceiling structure specified in the project specification.
- 6.11.2 The attachment of the prismatic diffuser or reflector shall be similar to that specified in paragraph 10 above.
- 6.11.3 The diffuser or reflector shall fit flush with the ceiling and the only visible portion shall be the reflector or diffuser.
- 6.11.4 Should the luminaire be so designed that a surrounding frame is visible, then this frame shall be manufactured of anodised aluminium. The frame shall form a neat trim with the ceiling. The corners of the surrounding frame shall be mitred and reinforced.
- 6.12. LOW-BRIGHTNESS LUMINAIRES
- 6.12.1 The luminaire shall be provided with an aluminium louver with V-shaped longitudinal vanes and extruded stepped cross-shielding plates.
- 6.12.2 Louvers shall be constructed from high purity aluminium (99,98%), chemically brightened and anodised.
- 6.12.3 The total Light Output Ratio (LOR) shall be 62% or better. In the plane between 60(and 90(from the vertical, the LOR shall be below 3%.
- 6.13. LOW GLARE LUMINAIRES
- 6.13.1 The luminaire shall be provided with a die-formed, bright anodised high-purity aluminium (99,98%) louver with parabolic reflecting surfaces in both directions.
- 6.13.2 The total LOR shall be 62% or better. In the plane between 60 and 90(from the vertical), the LOR shall be less than 1,3%
- 6.14. LUMINAIRES FOR USE IN AREAS WITH VISUAL DISPLAY TERMINALS
- 6.14.1 The luminaire shall have anodised specular louvers to provide the brightness control required for this type of application.

- 6.14.2 At angles between 60 and 90 (from the vertical) the luminance shall not exceed 200cd/m².
- 6.14.3 At the above angles the LOR shall be less than 0,6%. At angle between the vertical and 60 the LOR shall be 61% or better

7. AIR CONDITIONING UNITS

- 7.1. The installation of Air Conditioning Units shall comply with the relevant SABS regulations .All environmental regulations and relevant standards must be adhered to.
- 7.2. The contractor shall supply all the air conditioning units and all necessary material to complete the installation.

8. EARTHING ELECTRODES

8.1. GENERAL

This section covers uncoated, coated and metal clad circular rod electrodes intended to provide an earth in soil for electrical and lightning arrestor systems.

8.2. CATEGORY AND TYPE

- 8.2.1 Only the following type of earth rods shall be used:

- 1(a) - Solid copper.
- 1(b) - Solid stainless steel.
- 2(a) - Solid steel with bonded copper protection.
- 2(b) - Solid steel with plated copper protection.
- 2(c) - Solid steel with a shrunk-on copper jacket.
- 3 - Solid steel with a shrunk-on stainless steel jacket.
- 4 - Galvanised steel.

- 8.2.2 Bare aluminium is not acceptable as an electrode material.

- 8.2.3 All rods shall be solid and of circular cross section with length as specified in the Detail Technical Specification.

- 8.2.4 The nominal diameter of the earthing rods shall not be less than 16mm unless the rods are specified for placing in pre-drilled holes in which event the minimum nominal diameter shall not be less than 12 mm.

8.3. COUPLINGS AND CONDUCTOR CLAMPS

- 8.3.1 Earthing electrodes shall be provided with (n-1) couplings where n = number of rods supplied.
- 8.3.2 Rods designed for coupling by means of external sleeves shall be provided with an adequate quantity of hydrocarbon or silicon grease to be applied to the coupling before the joint is made.

- 8.3.3 Rods designed for coupling by means of internal pins or splines shall be provided with thin-walled tubes and hydrocarbon or silicon grease to seal the joint.
- 8.3.4 Conductor clamps shall be provided to suit the type and size of rods provided and the type and size of conductor specified in the Detail Technical Specification.
- 8.3.5 The material of the clamps shall be electrolytic compatible with the rod and conductor materials.
- 8.3.6 Where brazed or welded connections are specified, the supplier of the rods shall stipulate at least two types of metals which are compatible with the rod and conductor materials.
- 8.3.7 An adequate number of driving caps or bolts shall be supplied with the rods to protect the ends of the earthing rods whilst being driven into hard soil.

9. **SWITCHBOARDS (Up to 1 kV)**

9.1. GENERAL

1.1 Scope

This section covers the manufacturing and testing of flush mounted, surface mounted and floor standing switchboards for general installations in normal environmental conditions and for system voltages up to 1 kV.

9.1.2 Size

All switchboards shall be of ample size to accommodate the specified switchgear and provide space for future switchgear. For every 4 (or part of 4) 5kA circuit-breakers on a switchboard, space for an additional 5kA circuit breaker shall be allowed unless future space requirements are clearly specified. For circuit breakers above 5kA, this factor shall be 15 %. The clearance between adjoining switchgear openings shall be as specified in par. 6.2.

9.1.3 External Dimensions

The maximum allowable height of free standing switchboards is 2,2 m. Cubicle type boards may be up to 2,4 in height if they can be fully dismantled into individual cubicles. Where, due to space restrictions, a board exceeds 2,4m in height, equipment not normally requiring access, shall be installed in the top section, enabling equipment normally requiring access to be installed lower down in the board. All other specified external dimensions for switchboards shall be strictly adhered to. If the clearances specified in par. 6.2 cannot be adhered to as a result of restricting external dimensions, the Contractor shall obtain the approval of the Engineer before manufacturing the switchboards.

9.1.4 Moisture and Vermin

All switchboards shall be rendered moisture proof and vermin proof and shall be adequately ventilated. Refer to par. 4.10 and 4.11.

9.1.5 Load Balance

The load shall be balanced as equally as possible across multiphase supplies.

9.2. CONSTRUCTION OF FLUSH MOUNTED SWITCHBOARDS

9.2.1 Standard

Flush mounted switchboards shall comply fully with SABS 1180, part I unless the depths of the switchboards are specified, the depths shall be determined in accordance with par. 6.

9.2.2 Expanded Metal

Where switchboards are to be built into 115 mm thick walls, expanded metal shall be spot-welded to the rear of the bonding trays. The expanded metal shall protrude at least 75 mm on each tray side to prevent plaster from cracking.

9.2.3 Knock-outs

Knock-outs shall be provided in the top and bottom ends of each switchboard tray to allow for the installation of conduits for the specified and future circuits. Knock-outs shall be provided for an equal number of 20 mm and 25 mm dia. conduits.

9.2.4 Panel

Front panels shall have machine punched slots for housing the specified and future flush mounted

Switch gear. The distance between the inside of the closed doors and the panel shall not be less than 20 mm. No equipment may be mounted on the panel unless the panel is permanently hinged to the switchboard frame.

9.2.5 Fixing of Front Panels

The front panel shall be secured to the architrave frame by means of 6mm studs and chromium-plated hexagonal domed nuts, hank nuts or captive fasteners. Alternatively the panel may be secured to the architrave frame by means of two pins at the bottom and a latch or lock at the top of the panel. Self-tapping screws will not be allowed. All front panels shall be provided with a minimum of one chrome plated handle.

9.2.6 Door Handles and Catches

Switchboard doors shall be equipped with handles and catches. Locks shall only be provided when specified. In all cases where lockable doors are required and in all cases where the switchboard doors are higher or wider than 450 mm, handles consisting of a push-button-and-handle combination with spring loaded catch or rotary handle-and-catch combination shall be installed. Switchboard doors smaller than 450 mm in height and width may be equipped with spring loaded flush mounted ring type latches. Square key operated catches are not acceptable unless specified.

9.3. CONSTRUCTION OF SURFACE MOUNTED SWITCHBOARDS

9.3.1 Standard

Surface mounted switchboards shall comply with SABS 1180, Part II.

9.3.2 Switchboard Tray

Surface mounted switchboards shall be equipped with a 1,6mm minimum sheet steel reinforced tray, suitably braced and stiffened to carry the chassis, door and equipment. Lugs to secure the switchboard to a vertical surface shall be provided.

9.3.3 Construction

All joints shall be welded or securely bolted. The tray shall be square and neatly finished without protrusions. The front tray sides shall be rounded with an edge of at least 20mm to accommodate flush doors.

9.3.4 Chassis

A sheet steel chassis for the mounting of equipment shall be bolted to the tray and shall comply with the requirements of par. 6.1 and 6.3.

9.3.5 Front Panel and Door

The front panel and door shall comply with par. 2.4 to 2.6 above. Doors shall fit flush in the tray when closed.

9.3.6 Dimensions

Unless the depth of the switchboards is specified, the dimensions shall be determined in accordance with the requirements of par. 6.2 and 6.3.

9.4. CONSTRUCTION OF FREE STANDING SWITCH BOARDS

9.4.1 Framework

A metal framework for free standing switchboards shall be manufactured from angle iron, channel iron or 2mm minimum folded metal. A solid U-channel base frame, sufficiently braced to support all equipment and span floor trenches and access holes shall be provided. Switchboards shall be of cubicle design with 2mm side panels forming divisions between cubicles. The maximum allowable cubicle width is 1,5m. (Refer also to par. 4.7). Joints shall be non-continuously butt-welded. Welds shall be ground smooth and the joint wiped with plumber's metal in order to provide a smooth finish. Switchboards wider than 2m shall be fitted with screwed eye-bolts attached to the framework to facilitate loading and transportation of the board.

9.4.2 Rear and Side Panels

The rear panels shall be removable and shall be manufactured from 2mm minimum sheet steel. The panels shall have returned edges which are recessed in the frame or which fit over lips on the switchboard frame. The panels shall be secured to the frame by means of studs and chromium-plated hexagonal domed brass nuts or hank nuts or captive fasteners equal or similar to "DZUS" or "CAMLOC". Where switchboards are intended for installation in vertical building ducts or against walls, the rear and side panels may consist of a single folded sheet which is either bolted or welded to the frame or which forms part of the folded metal frame.

9.4.3 Front Panels

9.4.3.1 The front panels of floor standing switchboards shall preferably be hinged except where flush mounted equipment prevents this. Alternatively, panels shall be secured by means of the methods described in par. 2.5. The panels shall be arranged in multi-tiered fashion to allow for the logical grouping of equipment in accordance with par. 6.

9.4.3.2 The hinged front panels shall have a dished appearance with 20mm upturns which fit over a lip on the switchboard frame. Alternatively the hinged panels shall have folded edges and shall be fitted flush or slightly recessed in the switchboard frame. The latter method shall be used where doors are required. (Also refer to par. 4.6). Corners shall be welded and smoothed.

9.4.3.3 The panels shall be of 2mm minimum sheet steel with machine punched slots to allow for the flush mounting of instrumentation, switchgear toggles and operating handles. A minimum clearance of 50mm shall be maintained between the rear of equipment mounted on the panels (taking into account terminals or other projections) and the frame and chassis of the switchboard. Separate panels shall preferably be provided for the mounting of instrumentation and for covering flush mounted switchgear. Enclosed switchgear with front panels e.g. combination fuse-switch units, may be flush mounted in the board in lieu of separate hinged panels.

9.4.3.4 Hinged panels shall be suitably braced and stiffened to carry the weight of flush mounted equipment and to prevent warping.

9.4.3.5 Hinged panels with flush mounted equipment and hinges of adequate strength to ensure smooth and reliable operation shall support panels higher than 600mm. 16mm pedestal or similar heavy duty hinges with single fixing bolts may be used on panels smaller than 600mm. On the larger panels long pedestal type hinges with two fixing bolts per hinge are preferred. Piano hinges are not acceptable for this application.

9.4.3.6 A tubular chromium-plated handle shall be fitted on each panel. The handle may be omitted if "DZUS" or "CAMLOC" fasteners are used.

9.4.3.7 Blanking plates shall be fitted over slots intended for future equipment. These plates shall be fixed in a manner which does not require the drilling of holes through the front panel. Dummy circuit-breakers may be fitted where applicable.

9.4.3.8 Front panels containing live equipment such as instrumentation or control switches, shall be bonded to the switchboard frame with a braided copper earth trap with an equivalent cross-sectional area of at least 4mm².

9.4.4 Securing of Front Panels

Hinged panels shall be secured in position by means of square key operated non-ferrous fasteners designed to draw the panels closed or similar quick-release fasteners. Self-tapping screws are not acceptable. Where non-hinged removable panels are specified, they shall be secured in position by means of 6mm studs and hexagonal chromed brass dome nuts and washers or hank nuts. Non-hinged removable panels may alternatively be secured in position by means of two pins at the bottom and a latch or lock at the top.

9.4.5 Chassis

A suitably braced chassis for the mounting of switchgear and equipment shall be firmly secured to the frame of the switchboard. The chassis shall be designed so that the switchgear can be installed in accordance with par. 6. Circuit-breakers and isolating switches which are not of the moulded-case air-break type and the insulators of busbars for ratings of 200 A and more may be secured directly to the framework. (Refer to par. 6.1).

9.4.6 Doors

- (a) Doors need only be provided when specified. Doors shall be arranged in multi-tiered fashion to allow for the logical grouping of equipment in accordance with par. 6.
- (b) Doors shall have a dished appearance with a minimum of 20 mm upturns which fit over a lip on the switchboard frame or shall fit flush in the switchboard frame. Corners shall be welded and smoothed.
- (c) Doors shall be of aluminium sheet steel with machine punched slots to allow for the flush mounting of instrumentation, control and protection equipment. Switchgear shall be flush mounted in the front panels behind the doors unless specified to the contrary. A minimum clearance of 50mm shall be allowed between the rear of equipment mounted on doors (including terminals and projections) and the frame, front panel and chassis).

- (d) Doors shall be suitably braced and stiffened to carry the weight of the equipment and to prevent warping.
- (e) Hinges for doors shall be provided as described in par. 4.3.5. At least three hinges shall be provided on doors higher than 1,2m.
- (f) Doors shall be fitted with handles consisting of a pushbutton-and-handle combination with spring loaded catch or a rotary handle-and-catch combination. Flush mounted ring type handles or square key operated latches are not acceptable. The same key shall fit all locks on the switchboard in cases where locks are required.
- (g) Doors shall be fitted with hypalon or neoprene seals.
- (h) Doors containing any electrical equipment shall be bonded to the switchboard frame with a braided copper earth wire with an equivalent cross-sectional area of at least 4mm².

9.4.7 Sections

For ease of transportation and to facilitate access to the allocated accommodation, switchboards may be dismantled into cubicles or sections. Each section shall be rigidly manufactured to ensure that damage to the switchgear will not occur during transportation and handling. Where required, switchboards shall have temporary wood or steel bracing to protect switchgear and facilitate handling.

9.4.8 Grouping of Switchgear

The switchgear shall be logically arranged and grouped as described in par. 6. Depending upon the number and size of components, a common front panel may be installed over one or more groups of equipment. All equipment shall be installed in accordance with the requirements of par. 6.

9.4.9 Cable Gland Plate

A cable gland plate shall be installed across the full width of each power cubicle at a minimum height of 300mm above the bottom of the switchboard to house the cable glands. A Steel cable channel or other approved support shall be provided to carry the weight of the cable and remove mechanical stress from the cable glands. A minimum distance as required by the bending radius of outgoing cables shall be provided between the lowest terminals of major equipment and the gland plate.

9.4.10 Ventilation

Switchboards shall be properly ventilated, especially cubicles containing contactors, transformers, motor starters, lighting dimmers and other heat producing equipment. Louvres shall be fitted to provide adequate upward or cross ventilation. All louvres shall be vermin proofed with 1,5mm brass mesh or perforated steel plate internally spot welded over the louvres. The internal ambient temperature shall not exceed 40 C.

9.4.11 Vermin Proofing

Free standing boards shall be protected against vermin, especially from below- Where cables have to pass through the gland plate, rubber grommets shall be provided and enough non-hardening compound shall be delivered with the board so that these holes can be sealed properly after installation of the cables.

9.5. CONSTRUCTION OF MAIN LOW TENSION SWITCHBOARDS

Main low tension switchboards and sub-main low tension switchboards heavily equipped shall comply with par. 4.1 to 4.11 as well as the following exceptions or additions:

- (a) These boards shall be fully extensible with removable busbar cover plates in the side panels.
- (b) Doors shall not be supplied unless specifically called for.
- (c) Switchgear and equipment shall be installed in accordance with the requirements of par. 6.
- (d) Provision for metering equipment shall be made in accordance with requirements of local authorities where applicable.

9.6. MOUNTING OF EQUIPMENT

9.6.1 The mounting of equipment shall comply with SABS 1180 where applicable. Equipment to be mounted on the chassis shall be mounted by bolts, washers and nuts or by boltsscrewed into tapped holes in the chassis plate. In the latter case the minimum thickness of the chassis plate shall be 2,5 mm. The latter method shall not be used where boards will be subject to vibration or mechanical shocks. Self-tapping screws will not be accepted.

9.6.2 Space Requirements

In designing the switchboards the following requirements shall be strictly adhered to:-

- (a) A minimum of 50 mm between any piece of equipment and the frame or internal partitioning. This minimum space is required on all sides of the equipment. In the case of a single row of single-pole circuit-breakers the spacing on one side of the row may be reduced to 25 mm if the incoming side of the circuit-breakers is busbar connected.
- (b) A minimum of 75 mm between horizontal rows of equipment. The maximum outside dimensions of equipment shall be considered.
- (c) Circuit-breakers up to a fault rating of 10 kA may be installed adjacent to each other. For higher ratings a minimum of 40 mm shall be allowed between circuit-breakers or isolators.
- (d) Sufficient space shall be provided for wiring allowing for the appropriate bending radius.
- (e) Space for future equipment shall be allowed as described in par. 1.2.

9.6.3 Mounting of Chassis

The chassis of flush mounted and smaller surface mounted boards shall be mounted in accordance with SABS 1180. For all free standing switchboards and surface mounted switchboards where the main switch rating exceeds 100 A (triple-pole), space for wiring shall be provided between the chassis and tray. This space shall be adequate to install the supply cable behind the chassis and terminate on the main switch without sharp bends in the cable cores.

9.6.4 Grouping of equipment

9.6.4.1 Equipment shall be arranged and grouped in logical fashion as follows:

- (a) Main switch - to be installed either at the top or bottom of the board.

- (b) Short circuit protection equipment - fuse gear or fuse-switches.
- (c) Change-over contactors or other contactors controlling the supply.
- (d) Motor supplies.
- (e) Fuse-switches for outgoing circuits.
- (f) Other circuits and equipment.

9.6.4.2 Where a portion of the equipment on the switchboard is supplied from a standby power source, the change-over contactor and the associated equipment shall be grouped in a separate compartment.

9.6.4.3 Where earth leakage units are required, the associated circuit-breakers shall be installed adjacent to the unit.

9.6.5 Mounting of Circuit-Breakers

All moulded-case circuit-breakers shall be flush mounted with only the toggles protruding. Miniature circuit-breakers may be installed in clip-in trays mounted on the frame. All other circuit-breakers shall be bolted to the chassis. Special provision shall be made for large main switches when designing the framework. Care shall be exercised that the rear studs of circuit-breakers are properly insulated from the steel chassis. Where necessary, insulating material shall be installed between the rear studs and the chassis. Circuit-breakers shall be installed so that the toggles are in the up position when "ON" and down when "OFF".

9.6.6 Instrumentation

All metering instruments shall be flush mounted in the front panel or door. The rear terminals of instruments mounted on doors shall be covered with an insulating material to prevent accidental contact. Current transformers for metering shall be mounted so that the rating plate is clearly visible. Fuses for instrumentation shall be mounted in an easily accessible position and clearly marked.

9.6.7 Mounting of Fuses

9.6.7.1 Fuse holders shall be mounted semi-recessed in the front panel so that fuses can readily be changed without removing the front panel. Busbar mounted fuses for instrumentation shall be used as far as possible.

9.6.7.2 Where equipment requiring fuses is specified on a board (fuse switches etc), a ruling shall be obtained from the Engineer on the quantity of spare fuses to be provided.

9.6.8 Equipment in Main Boards

Equipment in main low tension switchboards and sub-main boards shall be grouped in individual compartments. Equipment shall be installed as follows:

9.6.8.1 Rack-out type air circuit-breakers shall be mounted in the bottom section, flush behind the panel with the handle only protruding. If this is not possible, the panel shall be omitted and the air circuit-breakers installed behind a door.

9.6.8.2 If the main switch is a moulded-case circuit-breaker or isolator it shall be flush mounted.

9.6.8.3 Contactors controlling the supply shall be installed behind separate front panels.

9.6.8.4 All metering, protection and indicating equipment shall be clearly visible from the front of the board. Current transformer ratios and multiplication factors shall be clearly marked. Where doors are specified the equipment shall be installed flush in the doors and covered as described in par. 6.6.

9.6.8.5 All circuit-breakers and fuses (with the exception of fuse-switches) may be grouped together behind one or more panels as described in par. 4.8.

9.6.8.6 Fuses or fuse-switches providing back-up protection for circuit breakers, shall be grouped with the associated circuit-breakers. Exposed surfaces of fuse-switches shall be of the same finish and colour as the rest of the board where practical.

9.7. BUSBARS IN SWITCHBOARDS

9.7.1 Application

9.7.1.1 Busbars shall be manufactured of solid drawn high conductivity copper with a rectangular cross-section in accordance with the latest edition of SABS 784, SABS 1195 and BS 159 and BS 1433, where applicable.

9.7.1.2 Although SABS 784 refers only to overhead or rising busbars, busbars in switchboards shall comply with applicable sections of this specification especially as far as insulation and clearance values, creepage distance, joints, insulation resistance, dielectric strength, deflection test, absorption resistance and rated short time withstand current are concerned.

9.7.1.3 Busbars shall be supplied for the following applications:

- (a) Distribution of supply voltage.
- (b) Connection of equipment with ratings exceeding the current rating of 70mm² conductors (par. 8.6).
- (c) Connection of outgoing circuits with current ratings in excess of that allowed for 70mm² conductors (par. 7.8).
- (d) Collector bars for parallel cables (par. 8.1).
- (e) Connection bars for neutral conductors (par. 7.9).
- (f) Earth busbars (par. 7.10).
- (g) Connections to miniature circuit-breakers (par. 8.6).

9.7.2 See Part C15 for further details.

9.8. WIRING

9.8.1 Cabling

Cables connected to incoming or outgoing circuits shall be terminated on the gland plate supplied for this purpose. (Refer to par. 4.9). Power cables up to and including 70 mm² may terminate on clamp type terminals where the clamping screws are not in direct contact with the conductor. Connection to the equipment can then be made with cables that are similarly connected to the clamp terminal. All power cables larger than 70mm² terminate on busbars that are connected to the associated equipment. Parallel incoming or outgoing cables shall be connected to a collector busbar without crossing the conductors.

9.8.2 Terminal Strips

External wiring for low voltage, control, interlocking, alarm, measuring and DC circuits shall terminate on numbered wiring terminals complying with the Engineer's standard specification for "WIRING TERMINALS", Section C9. The correct terminal size as recommended by the manufacturer for each conductor to be connected shall be used

throughout. The terminal numbers shall appear on the wiring diagrams of the switchboard. Terminals for power wiring shall be separated from other terminals. Terminals for internal wiring shall not be interposed with terminals for external circuits. All connections to terminals shall be identified as described in par. 8.8. Where switchboards consist of separate sections, the control wiring passing between sections shall be terminated on strips in each section so that control wiring can be readily re-instated when reassembling the board.

9.8.3 Current Ratings

The current rating of conductors for the internal wiring shall be sufficient for the maximum continuous current that can occur in the circuit. This value shall be determined from the circuit-breaker or fuse protection of the circuit.

TABLE 17.3

CURRENT RATING FOR INTERNAL WIRING

Nominal cross-section mm ²	CONDUCTOR RATING (A)				
	Number of conductors in bunch				
	1	2 - 3	4 - 5	6 - 9	10 and more
2,5	28	25	22	19	16
4	37	33	30	26	22
6	47	42	38	33	28
10	64	54	51	44	38
16	85	76	68	59	51
25	112	101	89	78	67
35	138	124	110	96	88
50	172	154	137	120	103
70	213	191	170	149	127

The above table shall be applied for ambient temperatures up to 30 C. (Refer to table 41.2 in VDE 0100). For higher ambient temperatures the values shall be derated as prescribed by SABS 0142, Table 10.

9.8.4 Internal Wiring

- (a) Standard 600/1 000 V grade PVC-insulated stranded annealed copper conductors to SABS 150 shall be employed for the internal power wiring of switchboards. The smallest conductor size to be used for power wiring in switchboards shall be 2,5mm². Flexible cord of minimum size 1,0mm² may be used for control wiring.
- (b) Where heat generating equipment is present and the internal temperature of the board is likely to exceed 50 C, silicon-rubber insulated stranded conductors shall be used.
- (c) Wiring shall be arranged in horizontal and vertical rows and shall be bound with suitable plastic straps or installed in PVC wiring channels. Under no circumstances may PVC adhesive tape be used for the bunching of conductors or for the colour identification of conductors.
- (d) Bunched conductors shall be neatly formed to present a uniform appearance without twisting or crossing the conductors. Conductors leaving the harnesses shall be so arranged that they are adjacent to the chassis.
- (e) Conductors to hinged panels and doors shall be secured on both the door and the

frame and shall be looped between the two points. The loop shall be arranged to produce a twisting motion when the door is opened or closed. A flexible protection sleeve shall be installed over the conductors.

- (f) Where wiring channels are used, they shall be installed horizontally and vertically. Under no circumstances may power and control circuit wiring be installed in the same wiring channels.

Channel shall not be more than 40% full.

- (g) All wiring between different Panels within the same switchboard shall be installed in wiring channels.
- (h) Grommets shall be installed in each hole in the metalwork through which conductors pass.
- (i) All wiring shall be installed away from terminals, clamps or other current carrying parts. Wiring shall also be kept away from exposed metal edges or shall be protected where they cross metal edges.
- (j) Conductors may be jointed at equipment terminals or numbered terminal strips only. No other connections are allowed.
- (k) Where conductors change direction, smooth bends shall be formed with a radius of at least 5 times the outside diameter of the conductor or harness.
- (l) Where screened cables are specified, the screening shall be earthed in the switchboard or control board only unless clearly specified to the contrary, Screened cables entering control boxes through pressed knock-outs, shall terminate in compression glands. Conductors shall as far as possible remain inside the screening at terminations. Where conductors have to separate from the screen, the braiding shall be separated and the conductors drawn through the braid without damaging the braiding. The conductors shall then be connected to their respective terminals and the screening smoothed and connected to the earth terminal.
- (m) Where neutral connections are looped between the terminals of instruments, it is essential that the two conductor ends be inserted into a common lug or ferrule and are crimped or soldered together in order that the neutral connection is not broken when the conductors are removed from one of the instruments.
- (n) Wiring should as far as possible be confined to the front portions of switchboards for ease of access. This requirement is important for wiring between smaller circuit-breakers and the associated main circuit-breaker as well as the wiring from circuit-breakers to lighting and socket-outlet circuits.
- (o) A maximum of two conductors will be allowed per equipment terminal. Where more conductors must be connected to the same equipment terminal (e.g. a main circuit-breaker feeding other circuit-breakers), stub busbars shall be provided for the various conductors. Refer also to par. 8.6.

9.8.5 Load End Connections

The supply end connections to all equipment shall under all circumstances be at the top and the load end connections at the bottom.

9.8.6 Wiring to Circuit-breakers

Equipment with a rating exceeding the current rating of 70mm² conductors shall be connected by means of busbars to the main busbars. Looped connections may only be

installed for a maximum of two outgoing circuits. Where there are more than two outgoing circuits, busbars shall be used and equipment connected individually to the busbars. Where miniature circuit-breakers are mounted in continuous rows and supplied by busbars connected to each MCB, each busbar shall be supplied by a separate conductor. This conductor shall be connected to the busbar by means of a separate lug and not via an MCB terminal.

9.8.7 Conductor Terminations

Conductors connected to terminals complying with the Engineer's standard specification for "WIRING TERMINALS", Section C9, need not be soldered or ferruled. Connections to circuit-breakers, isolators or contactors shall be made by one of the following methods:

- (a) A ferrule of the correct size,
- (b) soldering the end of the conductor, or
- (c) winding a conductor strand tightly around the end to totally cover the end.

All conductors terminating on meters, fuse holders and other equipment with screwed terminals shall be fitted with lugs. The lugs shall be soldered or crimped to the end of the conductor. The correct amount of insulation shall be stripped from the end to fit into the terminal. Strands may not be cut from the end of the conductor.

9.8.8 Identification

9.8.8.1 The colour of the conductors for all 220/250 V circuits shall correspond to the colour of the supply phase for that circuit. Neutral conductors shall be black.

9.8.8.2 All other conductors in the board, supplying control circuits, etc. shall be coded in colours other than those specified above. A colour code shall be devised for each board and the colour code shall be shown on the wiring diagrams.

9.8.8.3 All conductors that terminate at wiring terminals and all conductors used for the internal wiring of the switchboard, shall further be identified at both ends by means of durable cable marking ferrules. PVC or other tape is not acceptable.

9.8.8.4 The numbers on the markers shall be shown on the wiring diagrams.

9.9. PAINT FINISH

Metal components of the framework, panels and chassis shall be painted in accordance with the Engineer's "STANDARD PAINT SPECIFICATION", Section C39.

9.10. LABELLING

9.10.1 Care shall be taken to ensure that all equipment is fully labelled and that accurate descriptions and safety warning notices appear in three official languages (English, Afrikaans and Setswana).

9.10.2 Material

Engraved plastic or ivory sandwiched strips shall be used throughout. The strips shall bear white lettering on a black background for normal labels and red letters on a white or yellow background for danger notices.

9.10.3 Main Switchboards

Main switchboards and sub-main switchboards shall be supplied with the following bilingual labels:

- (a) Number and allocation of switchboard.

Example:

CONTROL BOARD A4
BEHEERBORD A4

Lettering: at least 10 mm high prominent position. Label on the outside in a prominent position.

- (b) Designation of busbar sections.

Example:

BUSBAR SECTION 2
GELEISTAMSEKSIE 2

Lettering: at least 10mm high. Label on the outside in a prominent position.

- (c) Designation of all switchgear including circuit-breakers, isolators, contactors, etc. If the current rating of circuit-breakers is not clearly marked on the equipment, the value shall be indicated on the engraved label.

Example:

SUPPLY TO BOARD C3
TOEVOER NA BORD C3
PUMP SUPPLY
POMPTOEVOER

Letters at least 5mm high. Label on the outside of the switchboard.

- (d) All other equipment including meters, instruments, indicator lights, switches, push-buttons, circuit-breakers, fuses, contactors, control relays, protection relays, etc. shall be identified. The function of the equipment and circuits shall be clearly indicated. The main switch shall be labelled as such and designated:

"SWITCH OFF IN CASE OF EMERGENCY"

"SKAKEL AF IN NOODGEVAL"

Flush mounted equipment within doors or front panels shall be identified with labels fixed to the doors or front panels respectively. The labels for equipment installed behind panels, shall be fixed to the chassis close to the equipment. If this equipment is positioned too close together to accommodate descriptive engraved labels, the equipment may be identified by a code or number on an engraved label which shall be fixed close to the equipment. The code number shall be identified on a legend card which shall be installed on the switchboard behind a plastic or other protective cover.

9.10.4 Other Switchboards

All equipment on switchboards shall be identified with the necessary bilingual labels. The circuit numbers shall appear at grouped single-pole circuit-breakers. The circuit numbers shall correspond to the circuit numbers on the final installation drawings. The above-mentioned circuits shall be identified on a legend card, which shall be installed on the inside of the switchboard door, or in any other position where it can conveniently be observed. All fuses, including instrument fuses, shall have labels stating function, fuse rating and duty or type where applicable. All other equipment shall be identified separately and their functions shall be clearly indicated.

9.10.5 Fixing of Labels

9.10.5.1. Labels shall not be fixed to components or trunking but to doors, panels, chassis or other permanent structures of the switchboard.

9.10.5.2. Engraved strips shall be secured to facilitate a neat alteration of the designation of the labels. Sufficient fixing points shall be provided to prevent labels from warping. Labels in slotted holders shall be secured in position to prevent unauthorised removal. Labels may be secured by the use of brass bolts and nuts, self-tapping screws, slotted label holders or pop-rivets.

9.11. TESTS

11.1 The Engineer shall be notified when the mechanical construction of the switchboard, i.e. frame, panels and base frame, is complete in order that it may be inspected at the factory.

11.2 Function tests of all equipment, control and interlocking circuits shall be conducted to the satisfaction of the Engineer. Testing equipment and facilities including instruments, dummy loads and additional switchgear and cables shall be provided by the Contractor at no extra cost. The Engineer shall be notified in writing two weeks in advance of any test to be conducted, to allow its representative to be present at such tests. A complete report on the tests shall be handed to the Engineer.

9.12. DRAWINGS

9.12.1 Drawings for Approval

A set of three prints of the shop drawings for the switchboards shall be submitted to the Engineer for approval before the boards are manufactured. The following information shall be presented:

- (a) A complete wiring diagram of the equipment on the boards.
- (b) A complete layout of the arrangement of the switchboards indicating all equipment dimensions and the construction of the boards. The positions and method of fixing and sizes of busbars shall be shown.
- (c) All labelling information in both the official languages on a separate sheet.
- (d) The make, catalogue number and capacity of all equipment such as isolators, circuit-breakers, fuses, contactors, etc.

The approval of drawings shall not relieve the Contractor of his responsibility to the Engineer to supply the switchboards according to the requirements of this Specification.

9.12.2 Final Drawings

A complete set of "as-built" transparent drawings of all switchboards shall be submitted to the Engineer within two weeks after delivery of the boards. The following information shall be presented:

- (a) Item (a) to (d) of the previous paragraph.
- (b) Terminal strip numbers, numbers and colours of conductors connected to the terminal strips and numbers and colours of the conductors utilised for the internal wiring.
- (c) A separate schedule of all equipment.

9.12.3 Manuals

Three sets of manuals for all specified main and sub-main switchboards shall be supplied to the Engineer at no extra cost. These manuals shall include the following information :

- (a) Complete information on the operation of the equipment.
- (b) Complete information for maintenance of the equipment.
- (c) Brochures and ordering information.

(d) A complete equipment list indicating quantities and relevant catalogue numbers.

9.12.4 Completion

The supply contract shall be regarded as incomplete until all tests have been conducted successfully and all drawings and manuals have been handed to the Engineer

10. MOULDED-CASE CIRCUIT-BREAKERS

- 10.1. This section covers single or multi pole moulded case circuit breakers for use in power distribution systems, suitable for panel mounting, for ratings up to 1 000 A, 600 V, 50 Hz.
- 10.2. The circuit breakers shall comply with SABS 156.
- 10.3. The continuous current rating, trip rating and rupturing capacity shall be as specified.
- 10.4. The contacts shall be silver alloy and shall close with a high pressure wiping action.
- 10.5. Where specified, the circuit breaker shall be capable of accommodating factory fitted shunt trip or auxiliary contact units or similar equipment.
- 10.6. The operating handle shall provide clear indication of "ON", "OFF" and "TRIP" positions.
- 10.7. The mechanism shall be of the TRIP-FREE type preventing the unit from being held in the ON position under overload conditions.
- 10.8. All moulded case circuit breakers in a particular installation shall as far as is practical be supplied by a single manufacturer.
- 10.9. The incoming terminals of single pole miniature circuit breakers shall be suitable for connection to a common busbar.
- 10.10. The circuit breaker shall have a rating plate indicating the current rating, voltage rating and breaking capacity.
- 10.11. Extension type operating handles shall be provided for units of 600 A rating and above.

11. EARTH LEAKAGE RELAYS

- 11.1. Earth leakage relays shall be single or three-phase units with a sensitivity of 30mA, with associated circuit breaker or on-load switch for use on 220/250V single phase or 380/433 V three phase, 50 Hz, supplies.
- 11.2. The units shall be suitable for installation in switchboards in clip-in trays or bolted to the chassis.
- 11.3. The earth leakage relay shall function on the current balance principle and shall comply with SABS 767 as amended, and shall bear the SABS mark. Integral test facilities shall be incorporated in the unit.
- 11.4. Circuit breakers with trip coils used integrally with earth leakage units (two pole for single phase units and three pole for three phase units) shall comply with SABS 156.
- 11.5. On-load switches used integrally with earth leakage units (two pole for single-phase units and three pole for three phase units) shall comply with SABS 152.
- 11.6.1. The fault current rating of the unit shall be 2,5kA or 5kA as required, when tested in accordance with SABS 156.

12. MICRO-GAP SWITCHES

- 12.1. Micro-gap switches shall be suitable for ratings up to 400 A at 660 V (triple pole) and may be used for main and distribution switches in domestic applications, offices, small factories and similar applications.
- 12.2. Double pole switches shall be suitable for voltages up to 230V \pm 10%.
- 12.3. The switches shall comply with SABS 152.
- 12.4. Micro-gap switches may be used on AC circuits only.
- 12.5. Metal clad and moulded casings are acceptable.
- 12.6. Micro-gap switches shall be capable of carrying rated current continuously and making and breaking rated current.
- 12.7. Heavy, fully accessible, brass terminals with two screws each shall be provided to facilitate easy wiring. Contacts shall have large contact surfaces, made from high quality material such as solid silver.
- 12.8. The "ON" and "OFF" positions and the rating of the switch shall be clearly and indelibly marked.

13. INDICATOR LIGHTS

- 13.1. Indicator lights shall be of neon, incandescent (filament) or LED types. Lamp voltages shall suit the supply or control voltage. Lamps shall be derated for continuous duty by using economy resistors or using input voltages at least 20 % lower than the rated lamp voltages.
- 13.2. Where LED's are used as indicators on main supply voltages a suitable current limiting capacitor and reverse voltage protection diode shall be used. For low AC or DC voltages (+ 24 V) a current limiting resistor will suffice.
- 13.3. Indicator lights shall comply with BS 1050 where applicable.

- 13.4. Indicator lights shall be suitable for installation in switchboard panels and doors and shall consist of interchangeable lenses, lamp base, suitably rated and accessible terminals and a chromed screw-on retaining ring or other suitable means to secure the units.
- 13.5. It shall be possible to replace lamps from the front of the panel without the use of tools.
- 13.6. Surface mounted indicator lights shall be housed in purpose-made boxes with suitable cover plates.
- 13.7. Indicator lights shall be equipped with standard removable legend plates. Alternatively, the function shall be clearly indicated by means of labels or by engraving on the lenses.
- 13.8. All indicator lights for a specific application or switchboard shall be from the range of one manufacturer and shall preferably be of the same size and shall use the same lamp types.
- 13.9. The following are the preferred colours for indicator lights:
- | | | |
|-----|--------|---|
| (a) | RED | : Abnormal state. |
| (b) | YELLOW | : Attention or caution. (or amber) |
| (c) | GREEN | : Ready for operation. |
| (d) | WHITE | : Circuit live or circuit operating (or clear) normally |
| (e) | BLUE | : Any function not covered by the above colours. |

14. TRIPLE POLE ON-LOAD ISOLATORS

- 14.1. This section covers switches suitable for panel mounting for use in power distribution systems up to 600 V, 50 Hz. Switches for motor isolation are included.
- 14.2. The switches shall be of the triple pole, hand operated type complying with SABS 152.
- 14.3. The switches shall have a high speed closing and opening feature.
- 14.4. The switches shall be suitably rated for the continuous carrying, making and breaking of the rated current specified as well as the through-fault current capacity as specified.
- 14.5. To distinguish the switches from circuit breakers the operating handles shall have a distinctive colour and/or the switch shall be clearly and indelibly labelled "ISOLATOR".

15. TIME SWITCHES

- 15.1. Time switches shall be of single-pole type, suitable for 220/250 V systems, with contacts rated for the duty to be performed with a minimum rating of 15A. Contacts shall be of high quality material, e.g. silver-plated or solid silver.
- 15.2. The clock shall be driven by a self-starting, hysteresis synchronous motor, keeping accurate mains time. All clocks shall be controlled by an electrically wound escapement providing the main spring with a minimum of 15 hours reserve in case of a power failure. The main spring shall be kept fully wound without the use of slipping clutch devices that may wear and fall out of adjustment.
- 15.3. The main spring shall have a minimum of 15 hours reserve under full load and if fully discharged, shall be completely rewound within 15 minutes of the restoration of power.

- 15.4. An external manual bypass switch shall be provided to permit the circuit to be switched "ON" or "OFF" manually without affecting the operation of the time switch.
- 15.5. The time switch shall have a 24 hour dial, with day and night indication, that can be set to switch in 30 minute steps. The dial shall be fitted with 48 tappets corresponding to 48 change-over operations in a 24 hour period.
- 15.6. The time switch shall be fitted with a day omission dial comprising a total of 14 tappets which can be set to switch in 12 hour steps.
- 15.7. The time switch shall be housed in a dust-tight moulded plastic or metal case, consisting of a plastic clip-on front cover and a moulded plastic or metal base. Time switches to be used for surface mounting on walls shall be provided with a suitably positioned 20mm conduit knock-out.

16. CONTACTORS

- 16.1. Contactors shall be of the open or totally enclosed, triple- or double-pole, electromechanically operated, air-break type suitable for 380/433 V or 220/250 V supplies and shall comply with SABS 1092.
- 16.2. Contactors shall have the following characteristics:
 - (a) Enclosed coil easily replaceable.
 - (b) A permanent air gap in the magnetic circuit to prevent sticky operation.
 - (c) Provision for quick and simple inspection of contacts.
 - (d) Clearly marked main and auxiliary terminals.
- 16.3. All parts shall be accessible from the front.
- 16.4. Contactors which are not located in switchboards shall be housed in enclosures which comply with IP 54 of IEC 144.
- 16.5. The current rating of the contactor shall be as specified for the circuit with a switching duty in accordance with the SABS 1092 or IEC 158-1, utilisation category AC1 for lighting and power circuits and utilisation category AC3 for motor starting.
- 16.6. In addition to the required current carrying capacity and switching duty of a contactor, the contactor chosen for a particular application shall be rated for the maximum through fault current allowed by the back-up protection devices at the point where the contactor is installed. Careful co-ordination of short circuit devices shall take place.
- 16.7. All laminations of the magnetic system of the contactor shall be tightly clamped. Noisy contactors will not be accepted.
- 16.8. Non-current-carrying metallic parts shall be solidly interconnected and a common screwed earth terminal shall be provided. The contactor shall be earthed to the switchboard earth bar.
- 16.9. Latched contactors shall be provided with a trip coil and a closing coil. The contactor shall remain closed after de-energising the closing coil and shall only trip on energising the trip coil.
- 16.10. Contactor operating coils shall have a voltage rating as required by the control circuitry and shall have limits of operation and temperature rise as specified in Clause 7.5 and Table IV of IEC 158-1. Latched contactors shall be capable of being tripped at 50 % of the rated

coil voltage.

- 16.11. Contactors for normal/standby changeover circuits shall be electrically and mechanically interlocked. Contactors in star-delta starters shall be electrically interlocked.
- 16.12. Contactors with provision to add auxiliary contacts and convert auxiliary contacts on site are preferred. Contactors with permanently fixed auxiliary contacts shall have at least 1 x N/O and 1 x N/C spare auxiliary contacts in addition to the contacts specified for control purposes and in addition to contacts required for self-holding operations or economy resistances. Where the number of auxiliary contacts required is greater than the number of contacts that can be accommodated on the contactor, an auxiliary relay or additional contactor shall be provided to supply the additional contacts.
- 16.13. It shall be possible to replace main contacts without disconnecting wiring.
- 16.14. Auxiliary contacts shall be capable of making, carrying continuously and breaking 6A at 230V AC, unity power factor for contactors used on 380-433/220-250 V systems.
- 16.15. Auxiliary contact functions required e.g. "lazy" contacts, late-make, late-break, make-before-break, etc. shall be inherent in the contact design. Under no circumstances may these functions be improvised by bending contacts, loading contacts, etc. These functions shall be available in all contactors.
- 16.16. Spare auxiliary contacts shall be wired to numbered terminal strips in the switchboard and shall appear on the switchboard drawings.
- 16.17. All contactors on a specific project shall be from a standard range of one single manufacturer, unless specified to the contrary.

17. STANDARD PAINT SPECIFICATION

17.1. FINISH REQUIRED

Metalwork of electrical equipment such as switchboards, equipment enclosures, sheet steel luminaire components, purpose-made boxes, etc. shall be finished with a high quality paint applied according to the best available method. Baked enamel, electrostatically applied powder coating or similar proven methods shall be used.

17.2. CORROSION RESISTANCE

Painted metal shall be corrosion resistant for a period of at least 168 hours when tested in accordance with SABS Method 155.

17.3. EDGES

Care shall be taken to ensure that all edges and corners are properly covered.

17.4. SURFACE PREPARATION

Surface preparation shall comply with SABS 064. Prior to painting, all metal parts shall be thoroughly cleaned of rust, mill scale, grease and foreign matter to a continuous metallic finish. Sand or shot blasting or acid pickling and washing shall be employed for this purpose.

17.5. BAKED ENAMEL FINISH

- 17.5.1 Immediately after cleaning all surfaces shall be covered by a rust inhibiting, tough, unbroken metal-phosphate film and then thoroughly dried.

- 17.5.2 Within forty eight (48) hours after phosphatising, a passivating layer consisting of a high quality zinc chromate primer shall be applied, followed by two coats of high quality alkyd-based baked enamel.
- 17.5.3 The enamel finish on metal luminaire components shall comply with SABS 783, Type III.
- 17.5.4 Other metal parts e.g. switchboard panels, etc., shall comply with SABS 783, Type IV with a minimum paint thickness after painting of 0,06mm. In coastal areas, the dry film thickness shall be increased to at least 0,1mm.
- 17.5.5 The paint shall have an impact resistance of 5,65 J on cold-rolled steel plate and a scratch resistance of 2 kg.
- 17.6. POWDER COATED FINISH (NOT TO BE USED LESS THAN 50km FROM SEASIDE)
- 17.6.1 Immediately after cleaning the metal parts shall be pre-heated and then covered by a microstructure paint powder applied electrostatically.
- 17.6.2 The paint shall be baked on and shall harden within 10 minutes at a temperature of 190 C.
- 17.6.3 The minimum paint thickness after baking shall be 0,05 mm. The dry film thickness shall be increased in coastal areas. The paint cover shall have an impact resistance of 5,65 J on cold-rolled steel plate and a scratch resistance of 2kg.
- 17.7. TOUCH-UP PAINT
- In the case of switchboards and larger equipment enclosures, a tin of matching touch-up paint not smaller than 1 litre shall be provided.
- 17.8. COLOURS
- 17.8.1 The colour of HV switchboards and HV switchgear enclosures shall be "DARK ADMIRALTY GREY", colour G12 of SABS 1091.
- 17.8.2 The colour of LV switchboards and equipment enclosures in buildings shall be "LIGHT ORANGE", colour B26 of SABS 1091 as recommended in SABS 0140, Part II unless specified to the contrary.
- 17.8.3 The colour of LV distribution kiosks and miniature substations shall be "AVOCADO GREEN", colour C17 or "LIGHT STONE", colour C37 of SABS 1091.
- 17.8.4 The standby power section of LV switchboards in buildings shall be coloured "SIGNAL RED", colour All of SABS 1091.
- 17.8.5 Switchboards for No-Break Power Supplies or sections of switchboards containing No-break power supplies, shall be coloured "DARK VIOLET", colour FO6 or "OLIVE GREEN", colour HO5 of SABS 1091**

PART 4: BILLS OF QUANTITIES

VLEIFONTEIN LIBRARY

ELECTRICAL WORKS

GENERAL NOTES

1. This Bill of Quantities forms part of, and must be read in conjunction with the specification.
2. The Electrical Engineer will check the completed bill of Quantities and reserves the right to adjust any individual price and to rectify any discrepancy whilst the total tender price as quoted remains unaltered.
3. The unit rate for each item in the Bills of Quantities shall include for all materials, labour, profit, transport, etc., everything necessary for the execution and complete installation of the work in accordance with the description.
4. The Bills of Quantities shall not be used for ordering purposes. The Contractor shall check the lengths of cables and overhead conductors on site before ordering any of the cables. Any allowance for off-cuts shall be made in the unit rates.
5. No alterations, erasure or addition is to be made in the text of the Bill of Quantities. Should any alteration, erasure or addition be made it will not be recognised but the original wording of the Bill of Quantities will be adhered to.
6. The rates shall exclude Value-Added Tax and the total carried over to the final summary in PART A which is the main contract document.
7. All material covered by this Specification shall, wherever possible, be of South African manufacture.

PART 5

SCHEDULE OF MATERIAL

PART 5: MATERIAL SCHEDULE ELECTRICAL & MECHANICAL INSTALLATIONS

The contractor shall complete the following schedules and submit them to the Representative/Agent within 21 days of the date of the acceptance of the tender.

The schedules will be scrutinised by the Representative/Agent and should any material offered not comply with the requirements contained in the specification, the Contractor will be required to supply material in accordance with the contract at no additional cost.

NB: Only one manufacturer's name to be inserted for each item.

Item	Material	Make or trade name	Country of origin
1.	Distribution boards		
2.	Circuit breakers 1P, 2P, 3P		
3.	On load isolators without trips		
4.	Contactors 1P, 2P, 3P		
5.	Earth leakage relays 1 phase		
6	Daylight sensitive switch		
7	Conduit		
8	Conduit boxes		
9	Surface switches		
10	Watertight switches		
11.	16A flush socket outlets		
12.	16A surface socket outlets		
13.	16A watertight socket outlets		
14	Type B: 4 INCH 10W LED downlight wall/ceiling mount with 120mins battery backup		
15	Type B: 4 INCH 10W LED downlight wall/ceiling mount		
15	Type D1 Round Downlighter, 1 x 18W, ceiling mount		
16	1200mm 34W LED IP66 corrosion proof light fitting		
17	1200mm 34W LED IP66 corrosion proof light fitting with 120mins battery backup		
18	1200x600mm LED panel recessed light fitting with with battery backup of up to 120mins		
19	18W LED rondo downlight		
20	18W LED rondo downlight with 120mins Battery backup		

NOTE:

Should the contractor wish to supply materials other than that originally offered, prior written approval must be obtained from the Representative/Agent before any orders are placed.

CONTRACTOR:

SIGNED: _____

DATE: _____

PART 6
DRAWINGS



Project No.: 0283

ELECTRICAL SPECIFICATION SHEET

Rev.	Date	Rev. Description	Prepared By	Concurred By
0	9-Sep-2021	First Issue	P Anie	EK Mensah

For Information Only

ELECTRICAL SPECIFICATION SHEET

LIGHTING																					
ITEM	Lighting Legend	Lighting Description	Image	Area of Installation																	
				Store/Micro com	Librarians' Office	Children room	Hall	Foyer	Waiting Area	Reception	Book/Study Space	Store	Computer room	Server room	Passage	Ablutions	Outdoor Lighting	Area Lighting			
1		TYPE B: 4 INCH 10W LED Downlight with battery backup of up to 120mins																	v		
2		TYPE B: 4 INCH 10W LED Downlight																	v	v	
3		18W LED RONDO DOWNLIGHT WITH DALI MODIFICATION		v	v	v							v								
4		18W LED RONDO DOWNLIGHT WITH DALI MODIFICATION WITH BATTERY BACKUP OF 120mins		v	v	v							v								
5		18W LED UP & DOWN FACING IP44 STAINLESS STEEL WALL LIGHT																		v	
6		15W LED ROUND BULKHEAD																		v	
7		1200mm 34W LED IP66 CORROSION PROOF LIGHT FITTING BATTERY BACKUP OF 120mins												v						v	
8		35W 1200x600mm LED PANEL RECESSED LIGHT FITTING with emergency backup of up to 120mins						v	v	v	v	v									
9		35W 1200x600mm LED PANEL RECESSED LIGHT FITTING						v	v	v	v	v									
10		MOTION SENSOR		v									v								
11		DAY/NIGHT SWITCH																		v	v
Small Power																					
1		SINGLE 16A ZA PLUG SOCKET OUTLET @300 A.F.F.L		v	v	v	v	v	v	v	v	v	v	v	v	v	v	v	v		
2		DOUBLE 16A ZA PLUG SOCKET OUTLET @300 A.F.F.L		v				v						v	v						
3		FLOOR POP-UP CONSISTING OF THE FOLLOWING: 16A NORMAL SWITCHED SOCKET OUTLET 2x 16A NORMAL SWITCHED SOCKET OUTLET 2x 16A DATA & TELEPHONE POINTS 1x USB PORT				v								v	v						
4		TABLE/WORKSTATION POP-UP CONSISTING OF THE FOLLOWING: 16A NORMAL SOCKET UN-SWITCHED SA 2 PIN SOCKET UN-SWITCHED TELEPHONE POINTS DATA &																			v
5		16A SINGLE LEVER LIGHT SWITCH			v	v	v							v							v
6		2WAY 16A SINGLE LEVER LIGHT SWITCH																			v

Note(s):
 1. Architect to advise on Colour of light fittings and socket outlets

HA-TSHIKOTA-A

STATUS CODE

0 - Pre - Feasibility study

1 - Feasibility study
A - Preliminary Design

B - Design Review
C - Tender Design
D - Detailed Design
E - For Construction

Group Codes
BUILDINGS
BP - Building IT

BP - Building Public Address
BS - Building Service

BA - Building Architectural
BE - Building Electrical
BF - Building Fire Service
BM - Building Mechanical

DRAWING STATUS

FOR TENDER

PROJECT NUMBER

0283 - VL - TCS

F - As Built

BT - Building Public Telecoms

No	Date	chkd	Details	CLIENT
A	08.09.2021	EM	FOR TENDER	

CONSULTANT

Drawn By
By
oved By

PROJECT

TAKUSA HOUSE,
17a MAGAZYN STREET,
POLOKWANE,
0699

DRAWING TITLE

LIMPOPO NEW LIBRARIES PROJECT
VLEIFONTEIN LIBRARY

Designed
Reviewed/Apr

M.CHABALALA
ANIE
MENSAH

P
E
20100414

Copyright
Reserved

Project code	Status Group	Consultant	Doc Type	Seq No	Rev
VL - C - BE - TCS - TDW - 010 - A					

Name
S.A.I.D
Number
Name

Number
Name
Number
ure
Pr
Pr
Signat

LIBRARY SITE PLAN AREA LIGHTING LAYOUT

SCALE
 CHECKED/REV. No
 DATE

1:250
 A
 08.09.2021

G - For Information Only BU - Building Public Utilities

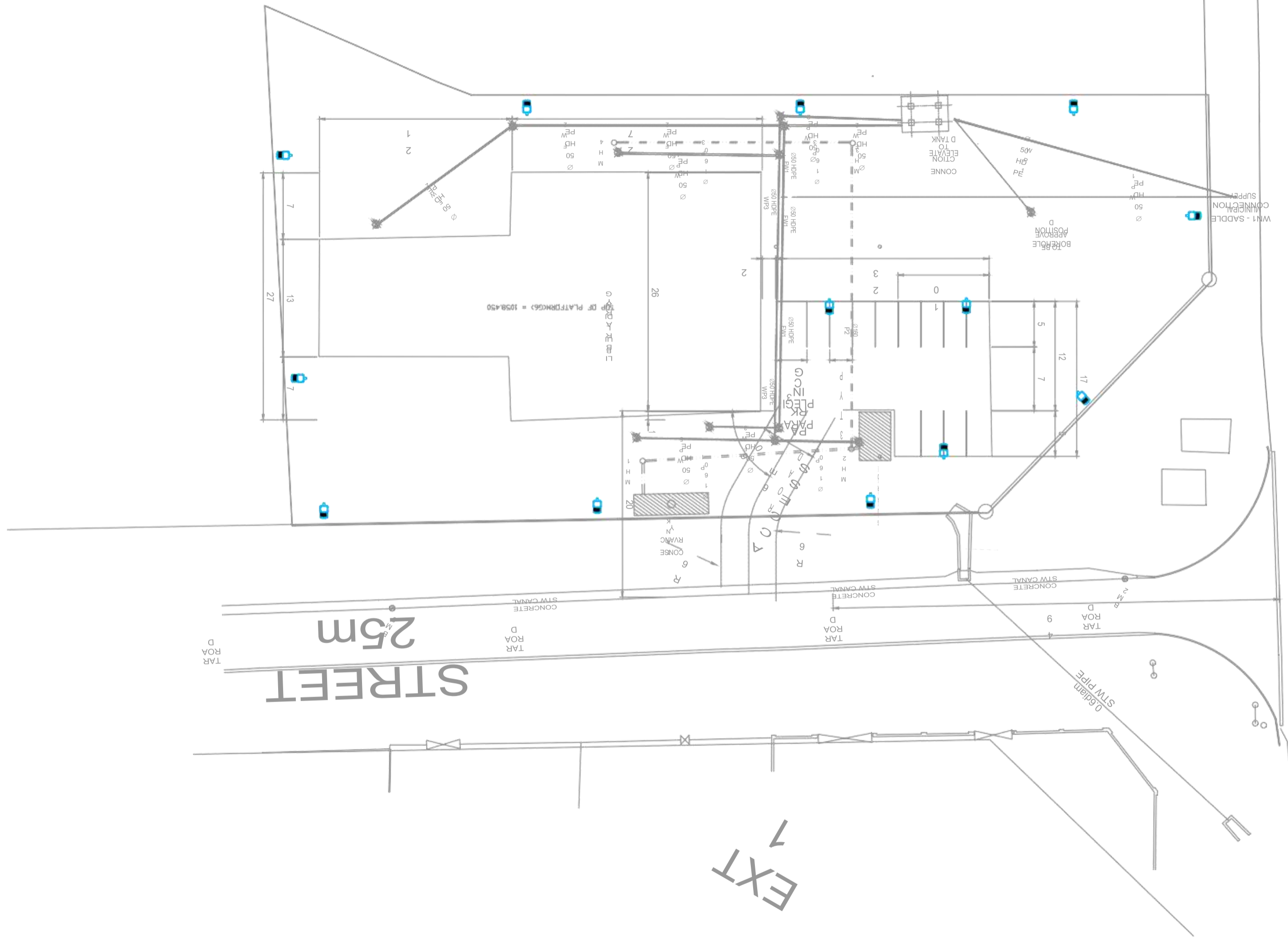

LEGEND		
Item	Description	Qty
	25W LED POST TOP LUMINAIRE MOUNTED ON 4M A POLE	00
	30W LED STREETLIGHT LUMINAIRE MOUNTED ON 4M A POLE	13

LIMPOPO
 PROVINCIAL GOVERNMENT
 REPUBLIC OF SOUTH AFRICA
 DEPARTMENT OF
 PUBLIC WORKS, ROADS & INFRASTRUCTURE

TAKUSA
 CONSULTING

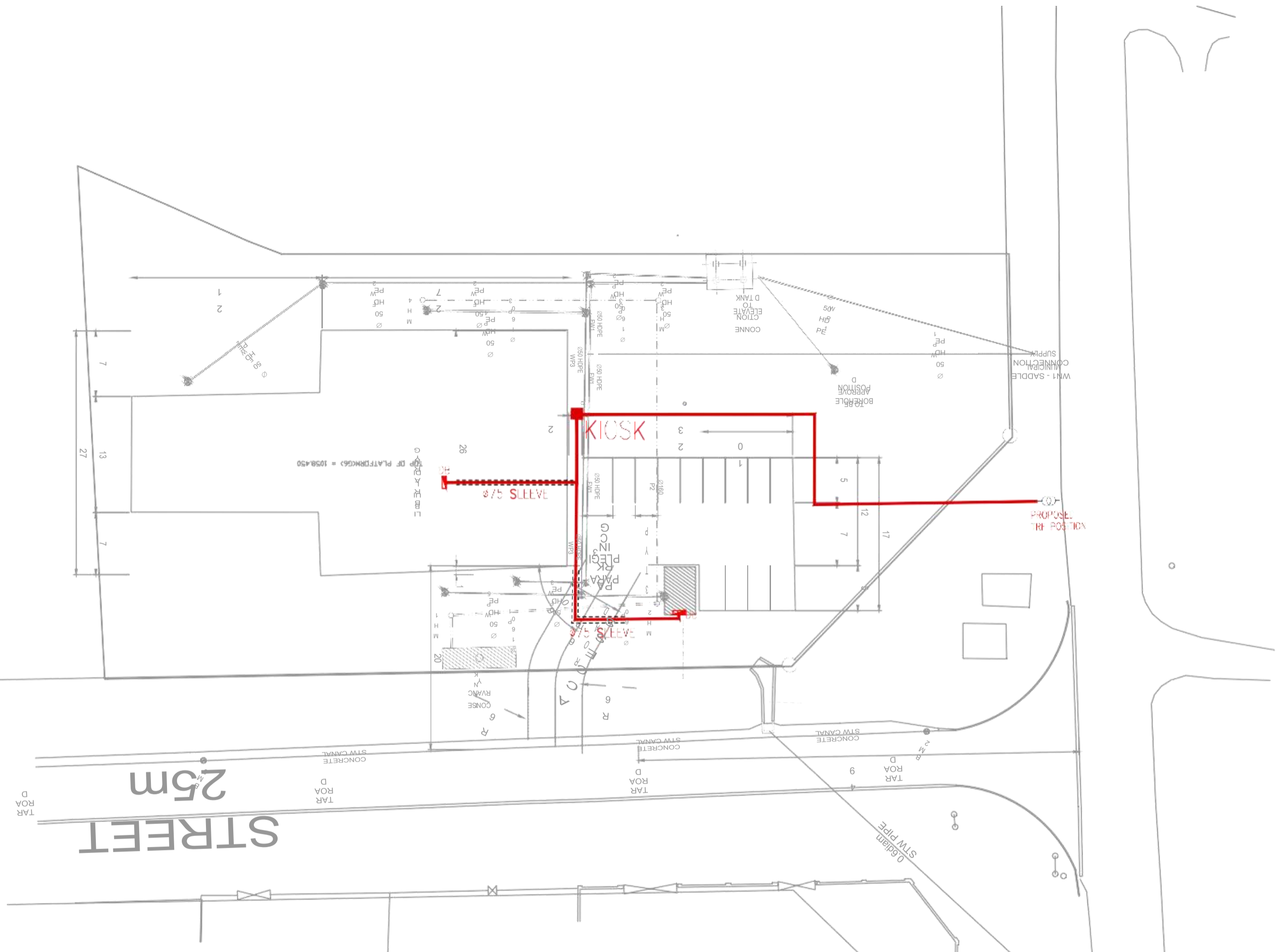

LELEND

ITEM	DESCRIPTION
	TRANSFORMER (TRF)
	MAIN KIOSK
	EXISTING DISTRIBUTION BOARD
	NEW DISTRIBUTION BOARD
	FUTURE DISTRIBUTION BOARD
	NEW LV RETICULATION LINE
	FUTURE LV RETICULATION LINE
	EXISTING LV RETICULATION LINE
	CORRUGATED SLEEVE
	MINIATURE SUBSTATION

STATUS CODE	Group Codes BUILDINGS
0 - Pre-Feasibility study	BP - Building IT
1 - Feasibility study	BP - Building Public Address
A - Preliminary Design	BS - Building Service
B - Design Review	BA - Building Architectural
C - Tender Design	BE - Building Electrical
D - Detailed Design	BF - Building Fire Service
E - For Construction	BM - Building Mechanical
F - As Built	BT - Building Public Telecoms
G - For Information Only	BU - Building Public Utilities

DRAWING STATUS	
FOR TENDER	
PROJECT NUMBER 0283 - VL - TCS	
Drawn By M CHABALALA	Designed By P ANIE
Name M CHABALALA	S.A.I.D Number
Name P ANIE	Pr Number
Name E MENSAH	Pr Number
Name 20100414	Pr Number
Signature	Signature

No	Date	chkd	Details
A	08.09.2021	EM	FOR TENDER

CLIENT

DEPARTMENT OF PUBLIC WORKS, ROADS & INFRASTRUCTURE

CONSULTANT

TAKUSA HOUSE,
17a MAGAZYN STREET,
POLOKWANE,
0699
Tel: 015 291 2154
Fax: 086 659 2099
Email: engage@takusaconsulting.co.za

PROJECT

LIMPOPO NEW LIBRARIES PROJECT
"VLEIFONTEIN LIBRARY"

DRAWING TITLE

LIBRARY SITE PLAN
SITE POWER RETICULATION LAYOUT

Project	Group	Consultant	Doc Type	Seq No	Rev
VL - C - BE - TCS - TDW - 000 - A					
SCALE					1:250
CHECKED					A
REV. NO					
DATE					08.09.2021

01 02 03 04 05 06 07 08 09 10 11

A

A

B

B

C

C

D

D

01 02 03 04 05 06 07 08 09 10 11



STATUS CODE

0 - Pre - Feasibility study

1 - Feasibility study

A - Preliminary Design

B - Design Review

C - Tender Design

D - Detailed Design

E - For Construction

F - As Built

G - For Information Only

Group Codes
BUILDINGS
BP - Building IT

BP - Building Public Address
BS - Building Service

BA - Building Architectural
BE - Building Electrical
BF - Building Fire Service
BM - Building Mechanical
BT - Building Public Telecoms

BU - Building Public Utilities

DRAWING STATUS

FOR TENDER

PROJECT NUMBER

0283 - VL - TCS

Drawn By

M CHABALALA

Designed By

P ANNE

Reviewed/Approved By

E MENSAH

20100414

Name

S.A.I.D. Number

Name

PI Number

Name

PI Number

Signature

Date

08.09.2021

EM

FOR TENDER

CLIENT

CONSULTANT

PROJECT

TAKUSA HOUSE, LIMPOPO NEW LIBRARIES PROJECT
VLEIFONTEIN LIBRARY

17a MAGAZYN STREET,
POLOKWANE,
0699

Tel: 015 291 2154
Fax: 086 659 2099
Email: engage@takusaconsulting.co.za

DRAWING TITLE

LIBRARY FLOOR PLAN
CCTV LAYOUT

Copyright Reserved

Project code Status Group Consultant Doc. Type Seq. No. Rev

VL - C - BE - TCS - TDW - 006/1 - A

SCALE 1:100

CHECKED A

REV. No.

DATE 08.09.2021

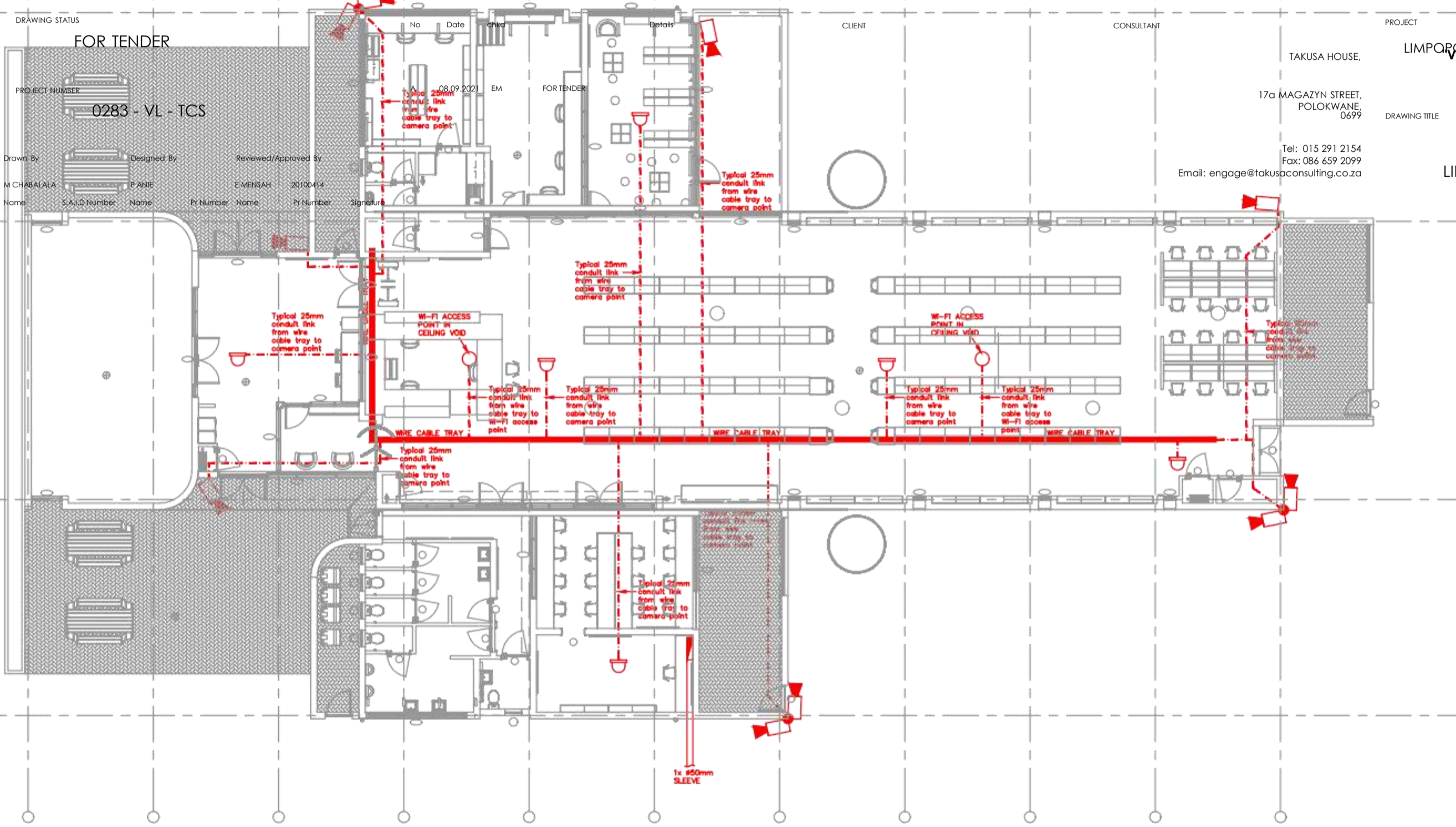

LEGEND	
ITEM	DESCRIPTION
	#50mm PVC SLEEVES
	25mm CONDUIT LINK
	INDOOR DOME CAMERA
	OUTDOOR BALLET CAMERA
	ELECTROGALVANIZED STEEL WIRE CABLE TRAY 200x100x30mm
	EQUIPMENT RACK

 LIMPOPO PROVINCIAL GOVERNMENT REPUBLIC OF SOUTH AFRICA DEPARTMENT OF PUBLIC WORKS, ROADS & INFRASTRUCTURE	 TAKUSA CONSULTING PTY LTD	PROJECT TAKUSA HOUSE, LIMPOPO NEW LIBRARIES PROJECT VLEIFONTEIN LIBRARY 17a MAGAZYN STREET, POLOKWANE, 0699 Tel: 015 291 2154 Fax: 086 659 2099 Email: engage@takusaconsulting.co.za	DRAWING TITLE LIBRARY FLOOR PLAN CCTV LAYOUT	SCALE 1:100	CHECKED REV. No. DATE	A 08.09.2021
---	----------------------------------	--	--	----------------	-----------------------------	-----------------



001 002 003 004 005 006 007 008 009 010 011

STATUS CODE	Group Codes
0 - Pre - Feasibility study	BUILDINGS BP - Building IT
1 - Feasibility study	BP - Building Public Address
A - Preliminary Design	BS - Building Service
B - Design Review	BA - Building Architectural
C - Tender Design	BE - Building Electrical
D - Detailed Design	BF - Building Fire Service
E - For Construction	BM - Building Mechanical
F - As Built	BT - Building Public Telecoms
G - For Information Only	BU - Building Public Utilities

DRAWING STATUS
FOR TENDER

PROJECT NUMBER
0283 - VL - TCS

Drawn By
M CHABALALA

Designed By
P ANIE

Reviewed/Approved By
F MENEMAH

No
A

Date
08.09.2021

chkd
EM

Pr Number
23100414

Name
S.A.I.D Number

Name
Pr Number

Signature

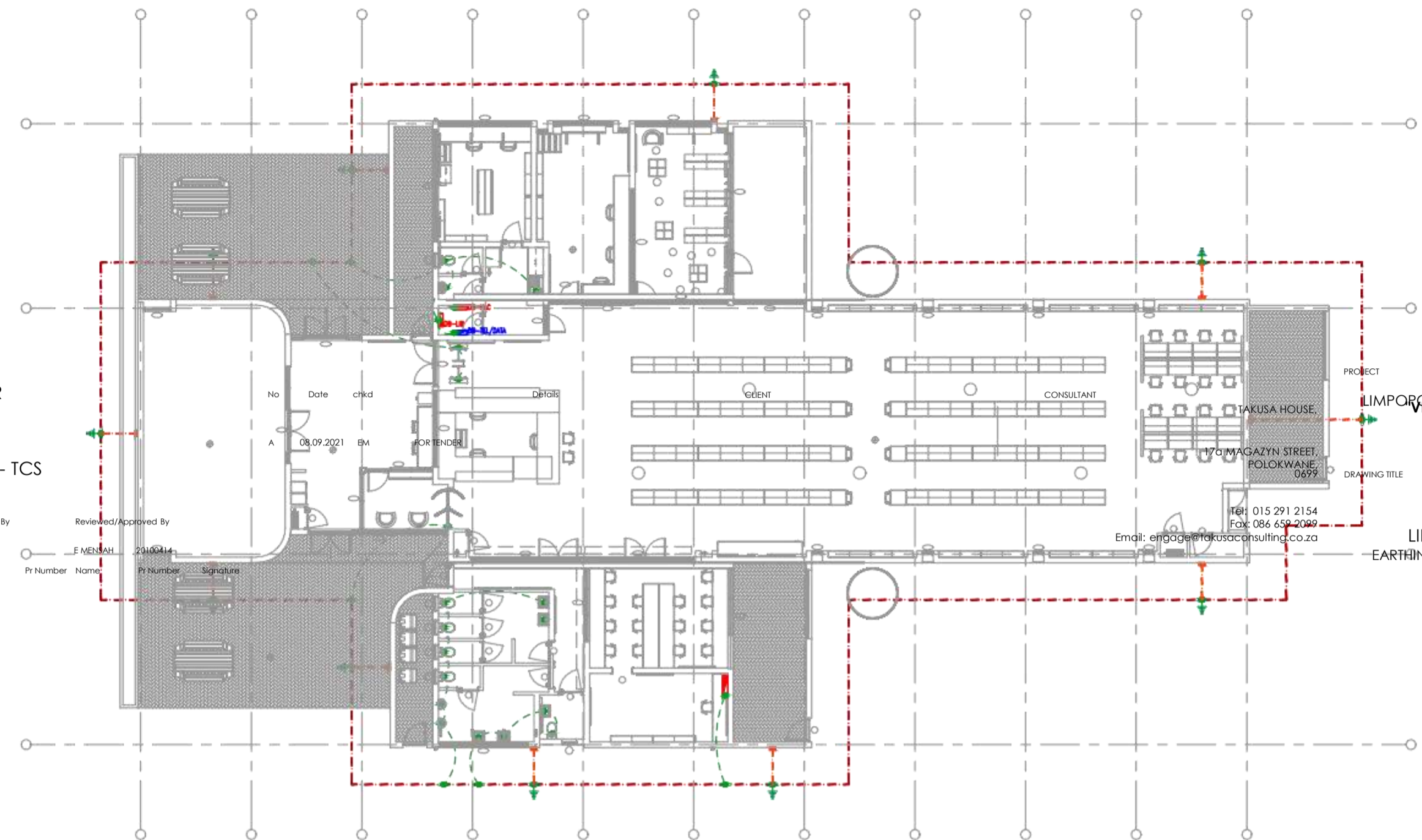

PROJECT
**LIMPOPO NEW LIBRARIES PROJECT
VLEIFONTAIN LIBRARY**

DRAWING TITLE
**LIBRARY FLOOR PLAN
EARTHING & LIGHTNING PROTECTION
LAYOUT**

Project code	Status	Group	Consultant	Doc Type	Seq No	Rev
VL - C - BE - TCS - TDW - 004/1 - A	Copyright Reserved					
SCALE						1:100
CHECKED						A
REV. No						08.09.2021
DATE						

GENERAL NOTES:

- EARTH TERMINATION CONDUCTOR TO BE 50mm² BICR.
- BONDING CONDUCTOR TO BE 16mm² BICR.
- EARTH ELECTRODE (SPIKE) TO BE #15mm x 1.5m LONG COPPER SOLID ROUND BAR, AND MUST BE 0.5m BURIED BELOW GROUND LEVEL.
- EARTH CONDUCTOR TO BE 0.5m BURIED BELOW GROUND LEVEL.

EARTH TERMINATION NOTES:

EARTH TERMINATION SYSTEM GENERAL REQUIREMENTS:

- TYPE B EARTHING ARRANGEMENT SHALL BE USED FOR ANY BUILDING INSTALLATION.
- THE RING EARTH ELECTRODE (TYPE B ARRANGEMENT) SHOULD PREFERABLY:
 - BE BURIED AT A DEPTH OF AT LEAST 0.5m AND
 - AT A DISTANCE OF ABOUT 1.5m AWAY FROM THE EXTERNAL WALLS UNLESS STATED OTHERWISE.
- THE CALCULATION OF AN EARTH TERMINATION SYSTEM SHALL BE DONE IN ACCORDANCE WITH THE FORMULAE IN SANS 10186.

DOWN CONDUCTORS:

- DOWN CONDUCTORS MUST BE INSULATED BY AT LEAST 3mm CROSS LINKED POLYETHYLENE.
- WARNING NOTICES TO BE INSTALLED TO MINIMIZE THE PROBABILITY OF DOWN CONDUCTORS BEING TOUCHED.

EARTHING TEST POINT:

- EARTHING TEST POINT SHOULD BE CAPABLE OF BEING OPENED WITH THE AID OF TOOL.

THE COMPLETE INSTALLATION MUST COMPLY TO THE FOLLOWING SANS SPECIFICATION:

- SANS 10142: THE WIRING OF PREMISES.
- SANS 10196: PART 3: EARTHING SYSTEMS GENERAL PROVISIONS.
- SANS 10196: PART 12: INSTALLATION OF EARTHING SYSTEMS.
- 10186: THE DESIGN AND INSTALLATION OF AN EARTH ELECTRODE.
- 10313: THE PROTECTION OF STRUCTURES AGAINST LIGHTNING.
- SANS 1043: EARTHING SYSTEMS GENERAL PROVISIONS.

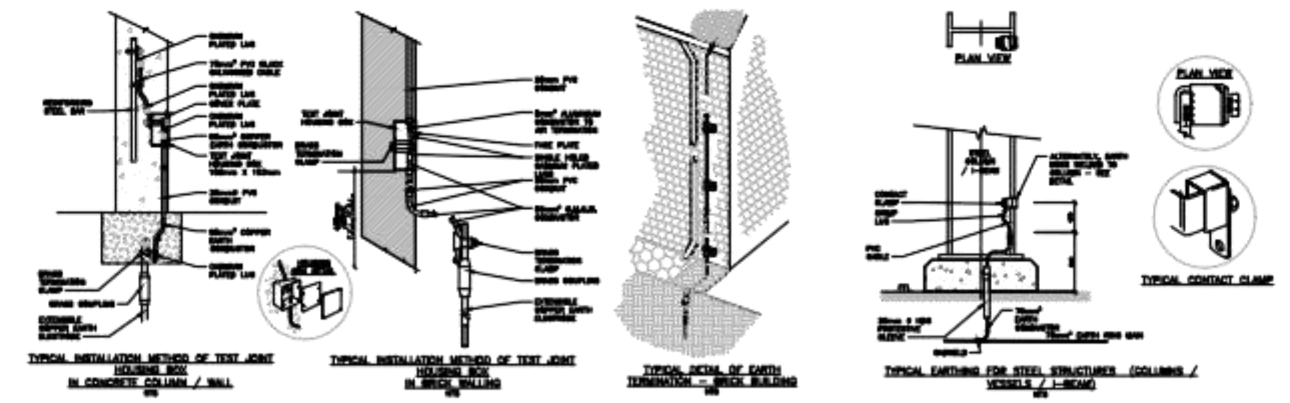
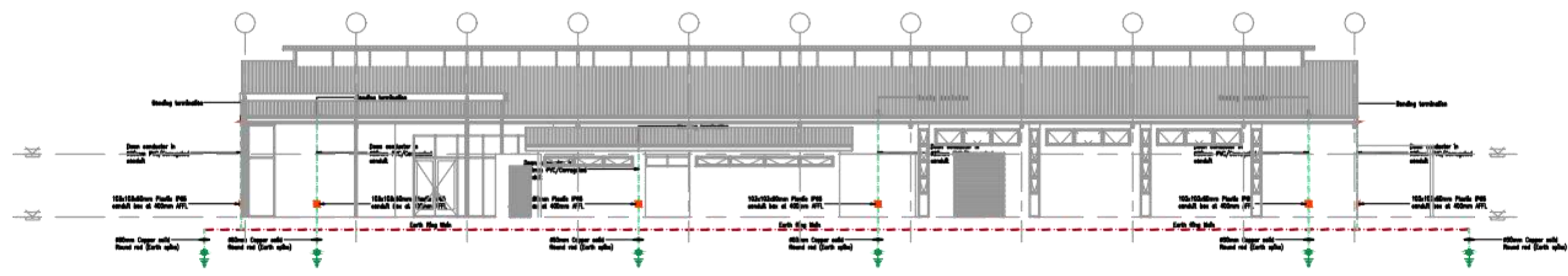

SYMBOL	DESCRIPTION
	EARTH CONDUCTOR
	EARTH RING BUS
	DOWN CONDUCTOR
	EARTHING ROD
	EARTH ELECTRODE (SPIKE)
	BONDING TERMINATION
	EARTHING TEST POINT



ITEM	LIGHTING LEGEND	QTY
	360 DEGREE MOTION SENSOR	02
	MOTION SENSOR	03
	16A SINGLE LEVER LIGHT SWITCH	06
2w	2-WAY 16A SINGLE LEVER LIGHT SWITCH	02
2w	2-WAY 16A DOUBLE LEVER LIGHT SWITCH	00
	TRIPLE LEVER LIGHT SWITCH	01
	MASTER KEY SWITCH	02
	DAY/NIGHT SWITCH	01
	TYPE B: 4 INCH 10W LED DOWNLIGHT WITH DALI MODIFICATION W/ WITH BATTERY BACKUP OF UP TO 120mins	04
	TYPE B: 4 INCH 10W LED DOWNLIGHT WITH DALI MODIFICATION	19
	18W LED RONDOD DOWNLIGHT WITH DALI MODIFICATION	22
	18W LED RONDOD DOWNLIGHT WITH DALI MODIFICATION W/ WITH BATTERY BACKUP OF UP TO 120mins	07

18W LED UP & DOWN FACING IP44 STAINLESS STEEL WALL LIGHT	07
OMNISTAR 14LED315W OPTIC 510 ASYMMETRICAL HIGH BAY LED	00
LED STRIP	00
15W LED ROUND BULKHEAD WITH DALI MODIFICATION	11
VISUAL LED IP40 - 38W 1200x60mm WITH DALI MODIFICATION NW RECESSED	09
VISUAL LED IP40 - 38W 1200x60mm WITH DALI MODIFICATION NW SUSPENDED LINEAR FITTING	36
1200mm 34W LED IP66 CORROSION PROOF LIGHT FITTING WITH DALI MODIFICATION - EMERGENCY	14
1200mm 34W LED IP66 CORROSION PROOF LIGHT FITTING WITH DALI MODIFICATION	05
1200x60mm LED PANEL RECESSED LIGHT FITTING WITH BATTERY BACKUP OF UP TO 120mins	11
1200x60mm LED PANEL RECESSED LIGHT FITTING WITH DALI MODIFICATION	43

STATUS CODE
0 - Pre-Feasibility study
1 - Feasibility study
A - Preliminary Design
B - Design Review
C - Tender Design
D - Detailed Design
E - For Construction
F - As Built
G - For Information Only

Group Codes
BUILDINGS
BP - Building IT
BP - Building Public Address
BS - Building Service
BA - Building Architectural
BE - Building Electrical
BF - Building Fire Service
BM - Building Mechanical
BT - Building Public Telecoms
BU - Building Public Utilities

DRAWING STATUS
FOR TENDER

PROJECT NUMBER
0283 - VL - TCS

CLIENT
TAKUSA HOUSE, LIMPOPO NEW LIBRARIES PROJECT

CONSULTANT
TAKUSA

PROJECT
LIMPOPO NEW LIBRARIES PROJECT

DRAWING TITLE
LIBRARY FLOOR PLAN LIGHTING LAYOUT

Address
17a MAGAZYN STREET, POLOKWANE, 0699

Contact Info
Tel: 015 291 2154
Fax: 086 659 2099
Email: engage@takusaconsulting.co.za

Project code
VL - C - BE - TCS - TDW - 002/1 - A

Scale
1:100

Checked
A

Date
08.09.2021

Author
M CHABALALA

Designer
F ANNE

Reviewer/Approver
E MEBEHAH

Date
08.09.2021

Project No
0283 - VL - TCS

Client
TAKUSA HOUSE

Consultant
TAKUSA

Project
LIMPOPO NEW LIBRARIES PROJECT

Drawing Title
LIBRARY FLOOR PLAN LIGHTING LAYOUT

Address
17a MAGAZYN STREET, POLOKWANE, 0699

Contact Info
Tel: 015 291 2154
Fax: 086 659 2099
Email: engage@takusaconsulting.co.za

Project code
VL - C - BE - TCS - TDW - 002/1 - A

Scale
1:100

Checked
A

Date
08.09.2021

Author
M CHABALALA

Designer
F ANNE

Reviewer/Approver
E MEBEHAH

Date
08.09.2021

Project No
0283 - VL - TCS

Client
TAKUSA HOUSE

Consultant
TAKUSA

Project
LIMPOPO NEW LIBRARIES PROJECT

Drawing Title
LIBRARY FLOOR PLAN LIGHTING LAYOUT

Address
17a MAGAZYN STREET, POLOKWANE, 0699

Contact Info
Tel: 015 291 2154
Fax: 086 659 2099
Email: engage@takusaconsulting.co.za

Project code
VL - C - BE - TCS - TDW - 002/1 - A

Scale
1:100

Checked
A

Date
08.09.2021

Author
M CHABALALA

Designer
F ANNE

Reviewer/Approver
E MEBEHAH

Date
08.09.2021

Project No
0283 - VL - TCS

Client
TAKUSA HOUSE

Consultant
TAKUSA

Project
LIMPOPO NEW LIBRARIES PROJECT

Drawing Title
LIBRARY FLOOR PLAN LIGHTING LAYOUT

Address
17a MAGAZYN STREET, POLOKWANE, 0699

Contact Info
Tel: 015 291 2154
Fax: 086 659 2099
Email: engage@takusaconsulting.co.za

Project code
VL - C - BE - TCS - TDW - 002/1 - A

Scale
1:100

Checked
A

Date
08.09.2021

Author
M CHABALALA

Designer
F ANNE

Reviewer/Approver
E MEBEHAH

Date
08.09.2021

Project No
0283 - VL - TCS

Client
TAKUSA HOUSE

Consultant
TAKUSA

Project
LIMPOPO NEW LIBRARIES PROJECT

Drawing Title
LIBRARY FLOOR PLAN LIGHTING LAYOUT

Address
17a MAGAZYN STREET, POLOKWANE, 0699

Contact Info
Tel: 015 291 2154
Fax: 086 659 2099
Email: engage@takusaconsulting.co.za

Project code
VL - C - BE - TCS - TDW - 002/1 - A

Scale
1:100

Checked
A

Date
08.09.2021

Author
M CHABALALA

Designer
F ANNE

Reviewer/Approver
E MEBEHAH

Date
08.09.2021

Project No
0283 - VL - TCS

Client
TAKUSA HOUSE

Consultant
TAKUSA

Project
LIMPOPO NEW LIBRARIES PROJECT

Drawing Title
LIBRARY FLOOR PLAN LIGHTING LAYOUT

Address
17a MAGAZYN STREET, POLOKWANE, 0699

Contact Info
Tel: 015 291 2154
Fax: 086 659 2099
Email: engage@takusaconsulting.co.za

Project code
VL - C - BE - TCS - TDW - 002/1 - A

Scale
1:100

Checked
A

Date
08.09.2021

Author
M CHABALALA

Designer
F ANNE

Reviewer/Approver
E MEBEHAH

Date
08.09.2021

Project No
0283 - VL - TCS

Client
TAKUSA HOUSE

Consultant
TAKUSA

Project
LIMPOPO NEW LIBRARIES PROJECT

Drawing Title
LIBRARY FLOOR PLAN LIGHTING LAYOUT

Address
17a MAGAZYN STREET, POLOKWANE, 0699

Contact Info
Tel: 015 291 2154
Fax: 086 659 2099
Email: engage@takusaconsulting.co.za

Project code
VL - C - BE - TCS - TDW - 002/1 - A

Scale
1:100

Checked
A

Date
08.09.2021

Author
M CHABALALA

Designer
F ANNE

Reviewer/Approver
E MEBEHAH

Date
08.09.2021

Project No
0283 - VL - TCS

Client
TAKUSA HOUSE

Consultant
TAKUSA

Project
LIMPOPO NEW LIBRARIES PROJECT

Drawing Title
LIBRARY FLOOR PLAN LIGHTING LAYOUT

Address
17a MAGAZYN STREET, POLOKWANE, 0699

Contact Info
Tel: 015 291 2154
Fax: 086 659 2099
Email: engage@takusaconsulting.co.za

Project code
VL - C - BE - TCS - TDW - 002/1 - A

Scale
1:100

Checked
A

Date
08.09.2021

Author
M CHABALALA

Designer
F ANNE

Reviewer/Approver
E MEBEHAH

Date
08.09.2021

Project No
0283 - VL - TCS

Client
TAKUSA HOUSE

Consultant
TAKUSA

Project
LIMPOPO NEW LIBRARIES PROJECT

Drawing Title
LIBRARY FLOOR PLAN LIGHTING LAYOUT

Address
17a MAGAZYN STREET, POLOKWANE, 0699

Contact Info
Tel: 015 291 2154
Fax: 086 659 2099
Email: engage@takusaconsulting.co.za

Project code
VL - C - BE - TCS - TDW - 002/1 - A

Scale
1:100

Checked
A

Date
08.09.2021

Author
M CHABALALA

Designer
F ANNE

Reviewer/Approver
E MEBEHAH

Date
08.09.2021

Project No
0283 - VL - TCS

Client
TAKUSA HOUSE

Consultant
TAKUSA

Project
LIMPOPO NEW LIBRARIES PROJECT

Drawing Title
LIBRARY FLOOR PLAN LIGHTING LAYOUT

Address
17a MAGAZYN STREET, POLOKWANE, 0699

Contact Info
Tel: 015 291 2154
Fax: 086 659 2099
Email: engage@takusaconsulting.co.za

Project code
VL - C - BE - TCS - TDW - 002/1 - A

Scale
1:100

Checked
A

Date
08.09.2021

Author
M CHABALALA

Designer
F ANNE

Reviewer/Approver
E MEBEHAH

Date
08.09.2021

Project No
0283 - VL - TCS

Client
TAKUSA HOUSE

Consultant
TAKUSA

Project
LIMPOPO NEW LIBRARIES PROJECT

Drawing Title
LIBRARY FLOOR PLAN LIGHTING LAYOUT

Address
17a MAGAZYN STREET, POLOKWANE, 0699

Contact Info
Tel: 015 291 2154
Fax: 086 659 2099
Email: engage@takusaconsulting.co.za

Project code
VL - C - BE - TCS - TDW - 002/1 - A

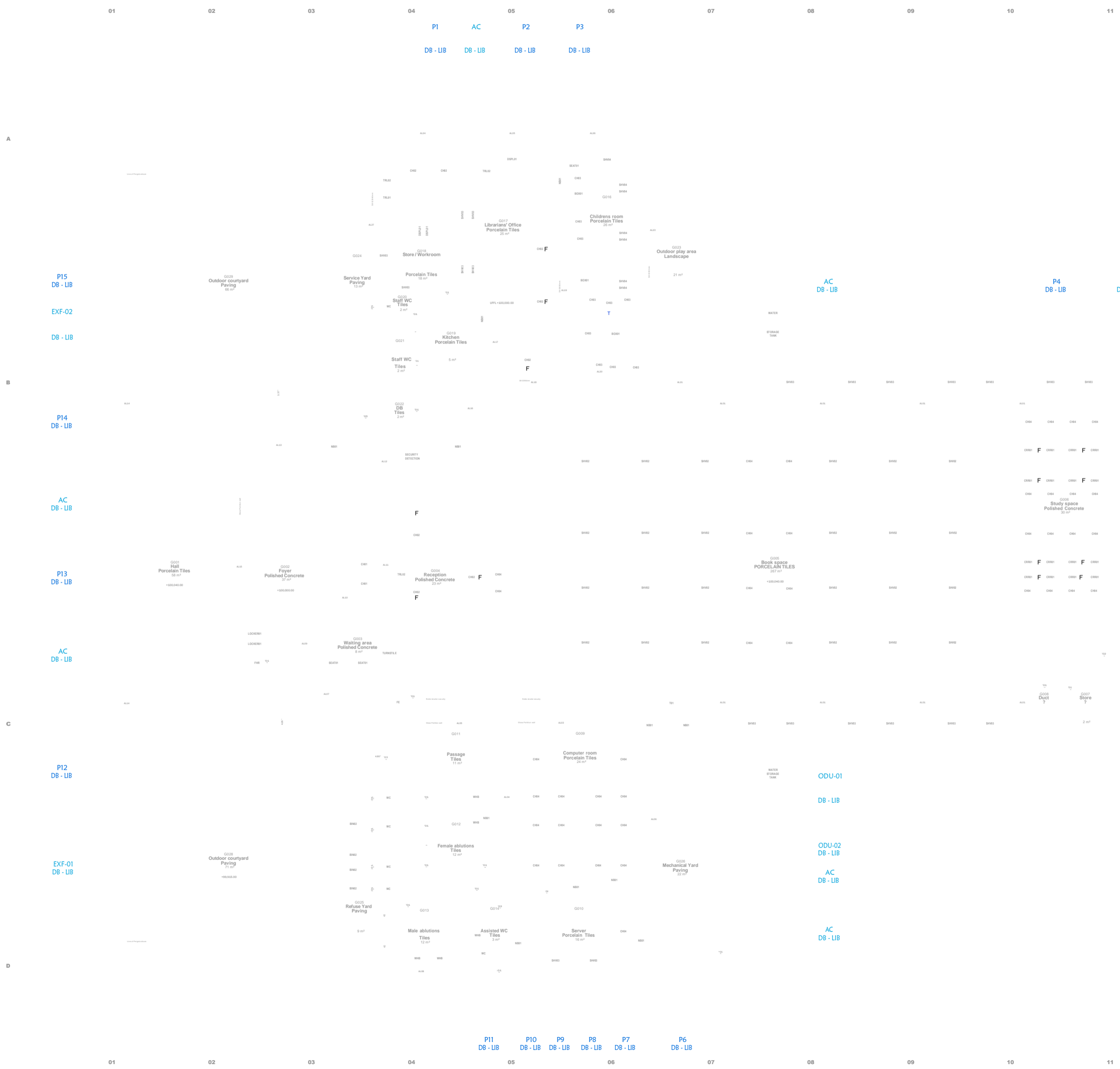

- RJ 45 data points and type a + type c usb ports for socket outlet modules
 Areas: Reception area; Waiting area; Librarian office

- proposed PVC/brushed stainless steel cover for socket outlets and floor pop-ups
 - Client to advise on type of module
 Areas:
 - Hall, Kitchen, children's room, book space & study area

- proposed socket outlet cover to be black powder coated metal plate
 - Client to advise on type of module
 - applicable to wall socket outlets and floor pop-ups
- Areas:
- Reception area; Waiting area; Librarian office

proposed Computer Room
small power installation

- STATUS CODE
- 0 - Pre-Feasibility study
 - 1 - Feasibility study
 - A - Preliminary Design
 - B - Design Review
 - C - Tender Design
 - D - Detailed Design
 - E - For Construction
 - F - As Built
 - G - For Information Only

- Group Codes
- BUILDINGS
 - BP - Building IT
 - BS - Building Public Address
 - BA - Building Service
 - BE - Building Electrical
 - BF - Building Fire Service
 - BM - Building Mechanical
 - BT - Building Public Telecoms
 - BU - Building Public Utilities

DRAWING STATUS: FOR TENDER

PROJECT NUMBER: 0283 - VL - TCS

Drawn By: N NGCEMU
Designed By: S RAMBAU
Reviewed/Approved By: E MENGARI

Date: 08.09.2021
EM FOR TENDER

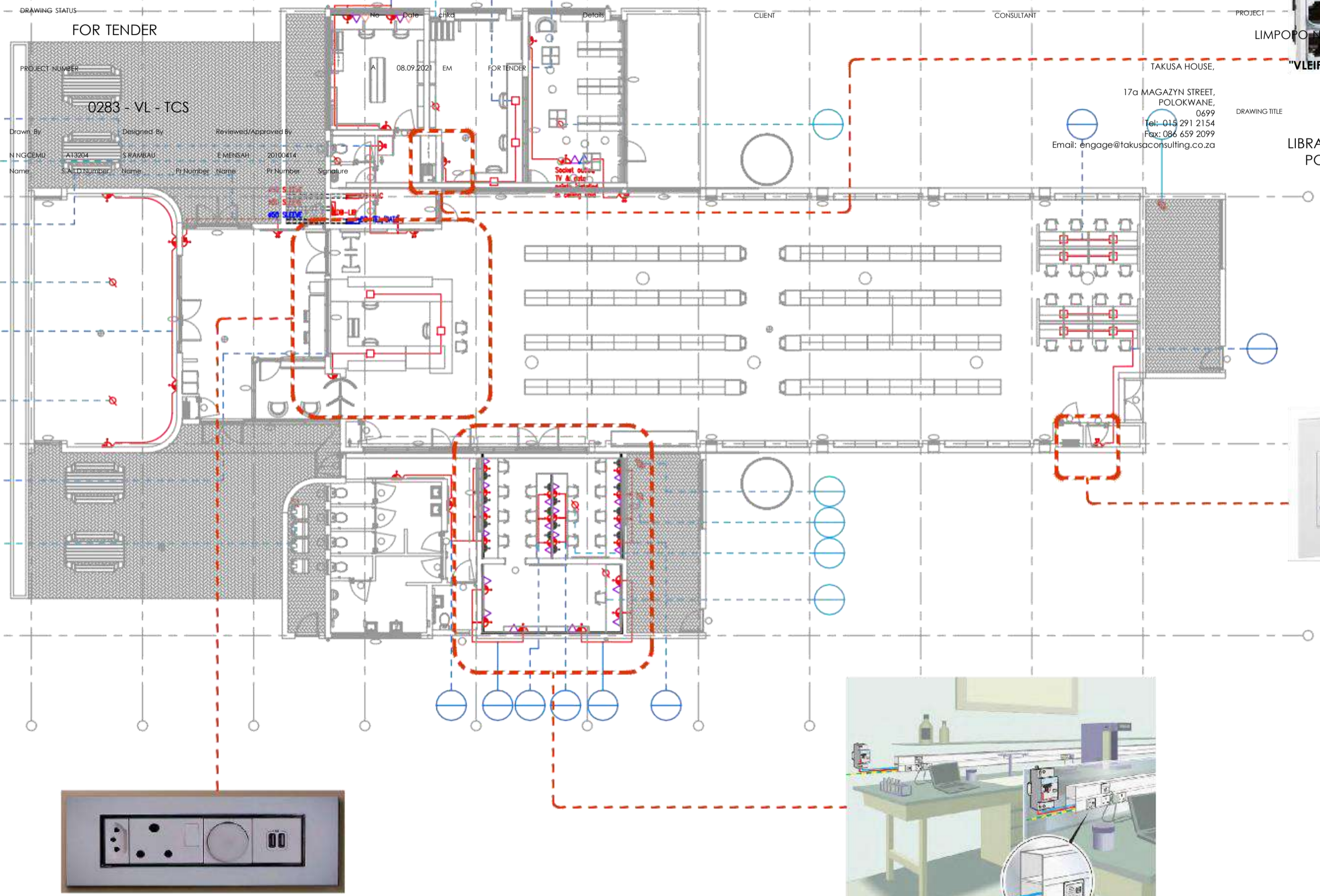

LIMPOPO NEW LIBRARIES PROJECT
"VLEIFONTEIN LIBRARY"

TAKUSA HOUSE,
17a MAGAZYN STREET,
POLOKWANE,
Tel: 013 291 2154
Fax: 084 659 2099
Email: engage@takusaconsulting.co.za

DRAWING TITLE: LIBRARY FLOOR PLAN POWER LAYOUT

SCALE: 1:100

CHECKED: A

REV. No: A

DATE: 08.09.2021

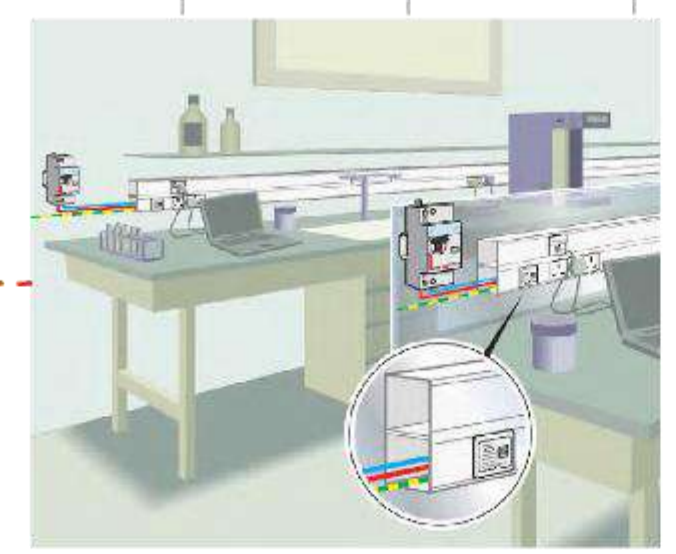

						 LIMPOPO PROVINCIAL GOVERNMENT REPUBLIC OF SOUTH AFRICA DEPARTMENT OF PUBLIC WORKS, ROADS & INFRASTRUCTURE		 TAKUSA CONSULTING			

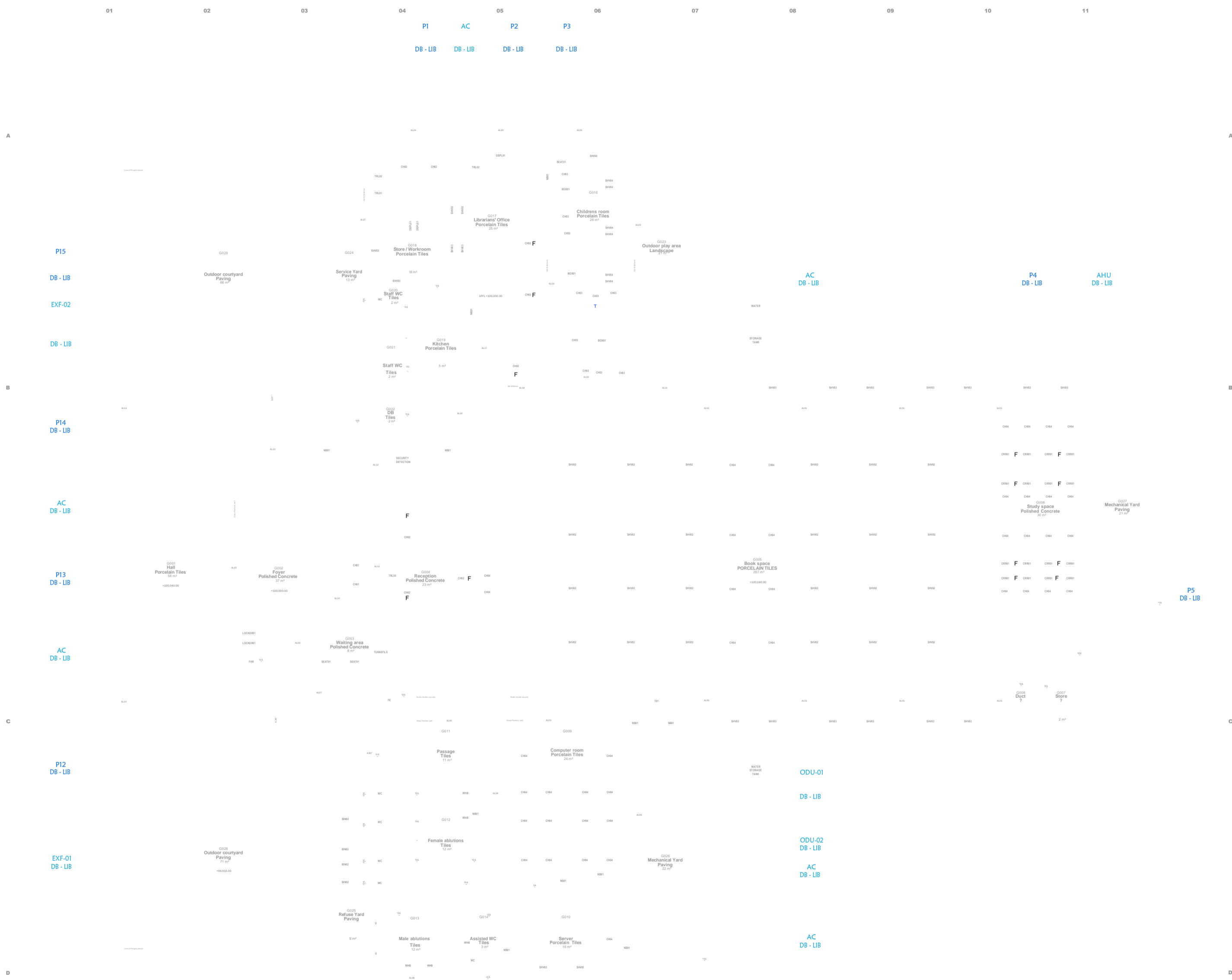

P1 AC P2 P3
 DB-LIB DB-LIB DB-LIB DB-LIB

P15
 DB-LIB
 EXF-02
 DB-LIB

P14
 DB-LIB
 AC
 DB-LIB

P13
 DB-LIB
 AC
 DB-LIB

P12
 DB-LIB
 EXF-01
 DB-LIB

AC
 DB-LIB

P4
 DB-LIB

AHU
 DB-LIB

P5
 DB-LIB

ODU-01

DB-LIB

ODU-02

DB-LIB

AC
 DB-LIB

P11 P10 P9 P8 P7 P6
 DB-LIB DB-LIB DB-LIB DB-LIB DB-LIB DB-LIB

POWER LEGEND

ITEM	DESCRIPTION
TV POINT	
TELEPHONE POINT	
DATA POINT	

STATUS CODE
 0 - Pre-Feasibility study
 1 - Feasibility study
 A - Preliminary Design
 B - Design Review
 C - Tender Design
 D - Detailed Design
 E - For Construction
 F - As Built
 G - For Information Only

Group Codes BUILDINGS
 BP - Building IT
 BS - Building Public Address
 BA - Building Architectural
 BE - Building Electrical
 BF - Building Fire Service
 BM - Building Mechanical
 BT - Building Public Telecoms
 BU - Building Public Utilities

DRAWING STATUS
FOR TENDER

PROJECT NUMBER
0283 - VL - TCS

Drawn By: M CHABALALA
 Designed By: P ANNE
 Reviewed/Approved By: E MENSBAH
 Date: 08.09.2021
 P-Number: 20100414

Name	S.A.I.D. Number	Name	P-Number	Name	P-Number	Signature
M CHABALALA		P ANNE	20100414	E MENSBAH		

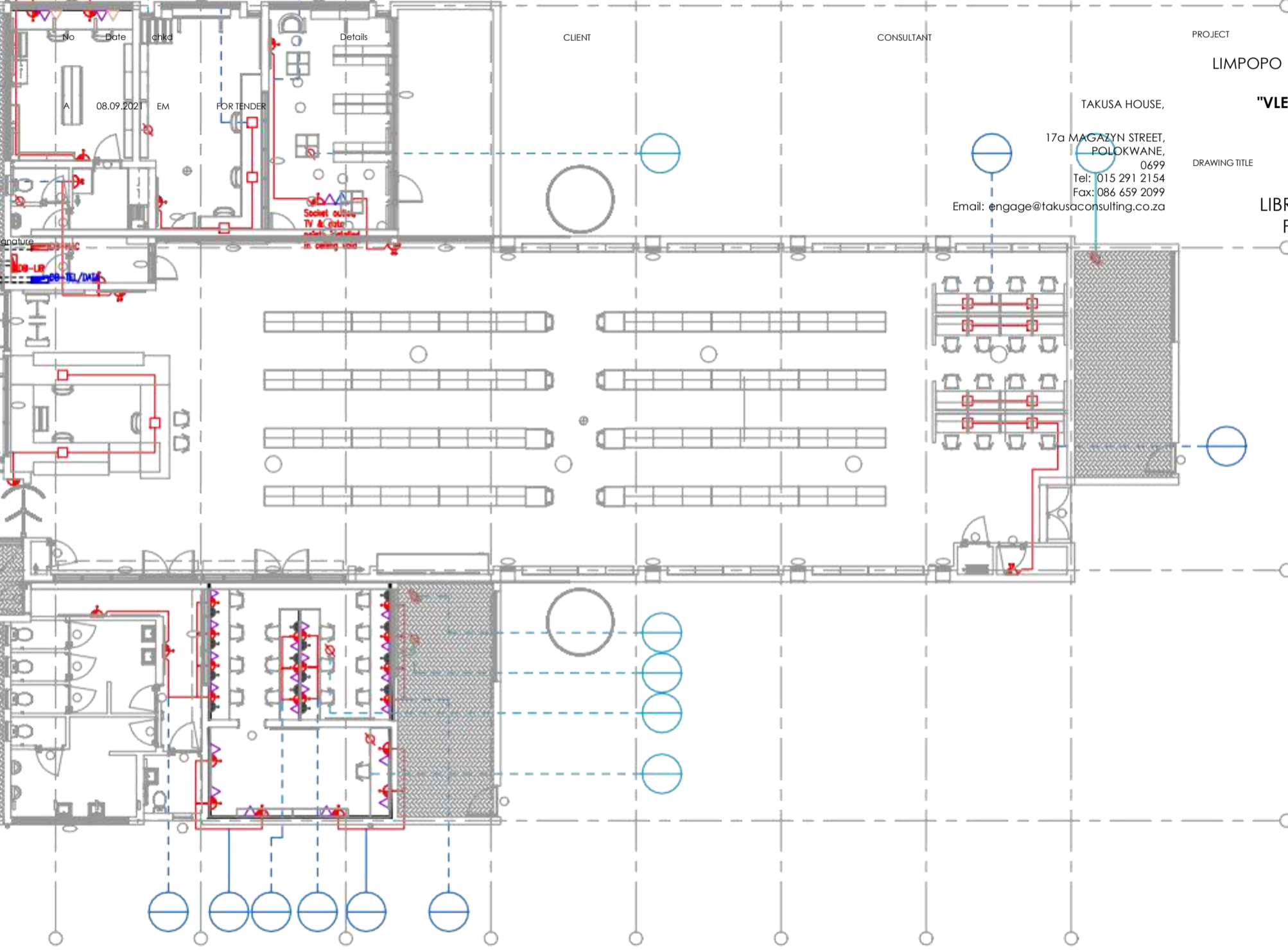

CLIENT
 CONSULTANT
 PROJECT
 LIMPOPO NEW LIBRARIES PROJECT
"VLEIFONTEIN LIBRARY"
 DRAWING TITLE
 LIBRARY FLOOR PLAN
 POWER LAYOUT

TAKUSA HOUSE,
 17a MAGAZYN STREET,
 POLOKWANE,
 Tel: 015 291 2154
 Fax: 086 659 2099
 Email: engage@takusaconsulting.co.za

- SINGLE PHASE ISOLATOR
 - THREE PHASE ISOLATOR
 - THREE PHASE INDUSTRIAL SOCKET OUTLET @ 1200 A.F.F.L
 - SINGLE 16A DEDICATED SOCKET OUTLET @ 300 A.F.F.L
 - SINGLE 16A 2A PLUG SOCKET OUTLET @ 1200 A.F.F.L
 - SINGLE SOCKET OUTLET CW EURO 3 PIN 2x USB POINTS @ 300 A.F.F.L
 - SINGLE 16A 2A PLUG SOCKET OUTLET @ 300 A.F.F.L
 - DOUBLE 16A 2A PLUG SOCKET OUTLET @ 1200 A.F.F.L
 - DOUBLE 16A 2A PLUG SOCKET OUTLET @ 300 A.F.F.L
 - POWER SKIRTING
 - POWER SKIRTING INSTALLED SUPPORTED AT TRUSS LEVEL
 - PEDESTAL FOR MEETING/PRESENTERS TABLE CONSISTING OF THE FF:
 - 16A NORMAL SOCKET UN-SWITCHED
 - 16A DEDICATED SOCKET UN-SWITCHED
 - SA 2 PIN SOCKET UN-SWITCHED
 - 2x USB POINTS
 - ONE TIER CLUSTER WALL BOX CONSISTING OF THE FOLLOWING:
 - 16A NORMAL SOCKET UN-SWITCHED
 - 16A DEDICATED SOCKET UN-SWITCHED
 - SA 2 PIN SOCKET UN-SWITCHED
 - 2x USB POINTS
 - ELECTRICAL DISTRIBUTION BOARD
- | Project code | Status | Group | Consultant | Doc Type | Seq No | Rev |
|-------------------------------------|----------|-------|------------|----------|--------|-----|
| VL - C - BE - TCS - TDW - 001/1 - A | Reserved | | | | | |
- SCALE 1:100
 CHECKED
 REV. No A
 DATE 08.09.2021

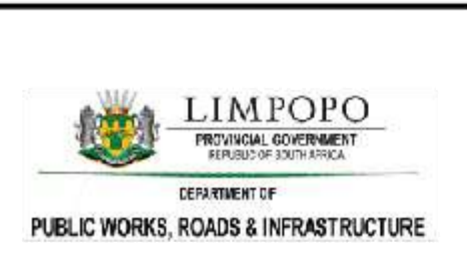

DB-CH GUARD HOUSE DB

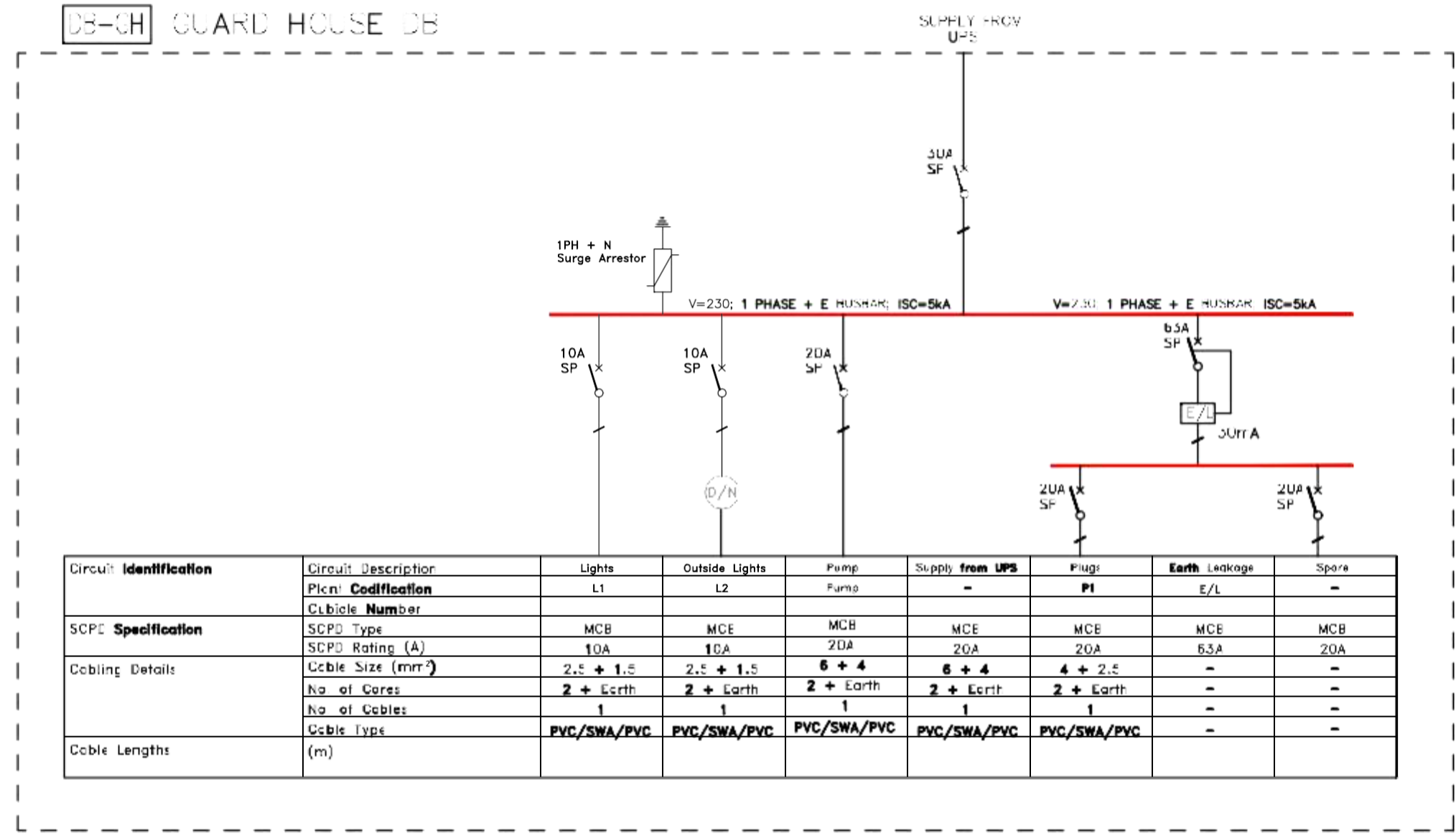

BOND PROPERTIES

Type	Flux
Material	-
IP Rating	44
Depth	-
Colour	Grey
Panels	2
Tray Size	-
Drawn	Yes
Access	Front
Cable Entry	Bottom
ConNA Exit	Top
Overriding Labels	Yes

QTY	DESCRIPTION	FULLY LEVEL
THREE PHASE BREAKERS		
To	Flux board with lockable door, fitted and wired with the following equipment	
To	30A Surge Arrestor	30A
To	6.5A SP	
To	10A SP	
To	20A SP	20A
SINGLE PHASE BREAKERS		
To	6.5A SP	
To	10A SP	
To	20A SP	20A

STATUS CODE	Group Codes BUILDINGS	DRAWING STATUS	
	0 - Pre - Feasibility study	FOR TENDER	
PROJECT NUMBER	BP - Building IT	No	Date
	0283 - VL - TCS	A	08.09.2021
Drawn By	BS - Building Service	chkd	Details
	BA - Building Architectural		
Designed By	BE - Building Electrical	CLIENT	
	BF - Building Fire Service	LIMPOPO PROVINCIAL GOVERNMENT	
Reviewed/Approved By	BM - Building Mechanical	DEPARTMENT OF PUBLIC WORKS, ROADS & INFRASTRUCTURE	
	BT - Building Public Telecoms	CONSULTANT	
Name	BU - Building Public Utilities	TAKUSA HOUSE, 17a MAGAZYN STREET, POLOKWANE, 0699	
S.A.I.D Number		Tel: 015 291 2154 Fax: 086 659 2099	
P ANIE		Email: engage@takusaconsulting.co.za	
E MENSAH		PROJECT	
20100414		LIMPOPO NEW LIBRARIES PROJECT	
		"VLEIFONTEIN LIBRARY"	
		DRAWING TITLE	
		GUARD HOUSE DB-GH	
		SINGLE LINE DIAGRAM LAYOUT	

Project code	Status	Group	Consultant	Doc Type	Seq No	Rev
VL - C - BE - TCS - TDW - 003/1/3 - A						
SCALE						NTS
CHECKED						A
REV. No						
DATE						08.09.2021

LIBRARY DB

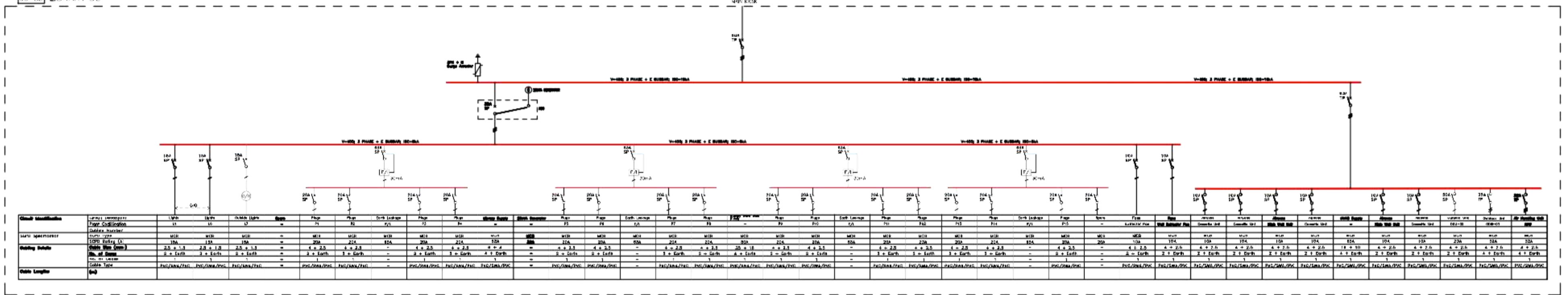

Group Identification	Phase	Line	Conductor	Size	Phase	Line	Conductor	Size	Phase	Line	Conductor	Size	Phase	Line	Conductor	Size	Phase	Line	Conductor	Size	Phase	Line	Conductor	Size	Phase	Line	Conductor	Size	Phase	Line	Conductor	Size	Phase	Line	Conductor	Size		
Wiring	100	100	100	100	100	100	100	100	100	100	100	100	100	100	100	100	100	100	100	100	100	100	100	100	100	100	100	100	100	100	100	100	100	100	100	100		
Wiring	200	200	200	200	200	200	200	200	200	200	200	200	200	200	200	200	200	200	200	200	200	200	200	200	200	200	200	200	200	200	200	200	200	200	200	200	200	
Wiring	300	300	300	300	300	300	300	300	300	300	300	300	300	300	300	300	300	300	300	300	300	300	300	300	300	300	300	300	300	300	300	300	300	300	300	300	300	300

BOARD PROFILES

Type	Fluor
Material	-
IP Rating	44
Depth	-
Colour	Orange
Mounts	2
Tray Size	-
Colour	Red
Access	Front
Cable Entry	Bottom
Outside Exit	Top/Bottom
Crossing Labels	Yes

QTY	DESCRIPTION	FAULT LEVEL
1x	Three Phase Breakers	
1x	100A SP	100A
1x	200A SP	200A
1x	300A SP	300A
1x	100A Surge Arrester	
1x	200A Surge Arrester	
1x	300A Surge Arrester	
4x	63A SP	63A
17x	100A SP	100A
7x	150A SP	150A
5x	200A SP	200A
4x	300A Earth Leakage	

STATUS CODE	Group Codes BUILDINGS	PROJECT NUMBER	No	Date	chkd	Details
0 - Pre - Feasibility study	BP - Building IT	0283 - VL - TCS	A	08.09.2021	EM	FOR TENDER
1 - Feasibility study	BP - Building Public Address					
A - Preliminary Design	BS - Building Service					
B - Design Review	BA - Building Architectural					
C - Tender Design	BE - Building Electrical					
D - Detailed Design	BF - Building Fire Service					
E - For Construction	BM - Building Mechanical					
F - As Built	BT - Building Public Telecoms					
G - For Information Only	BU - Building Public Utilities					

Drawn By	Designed By	Reviewed/Approved By
N NGCEMU A13204	P ANIE	E MENSAH 20100414
Name	S.A.I.D Number	Name Pr Number Signature

CLIENT

DEPARTMENT OF PUBLIC WORKS, ROADS & INFRASTRUCTURE

CONSULTANT

TAKUSA HOUSE, 17a MAGAZYN STREET, POLOKWANE, 0699
Tel: 015 291 2154 Fax: 086 659 2099
Email: engage@takusaconsulting.co.za

PROJECT

LIMPOPO NEW LIBRARIES PROJECT
"VLEIFONTEIN LIBRARY"

DRAWING TITLE

LIBRARY DB-LIB
SINGLE LINE DIAGRAM LAYOUT

Project code	Status	Group	Consultant	Doc Type	Seq No	Rev
VL - C - BE - TCS - TDW - 003/1/2 - A						
SCALE						NTS
CHECKED						A
REV. No						
DATE						08.09.2021

MAIN KIOSK

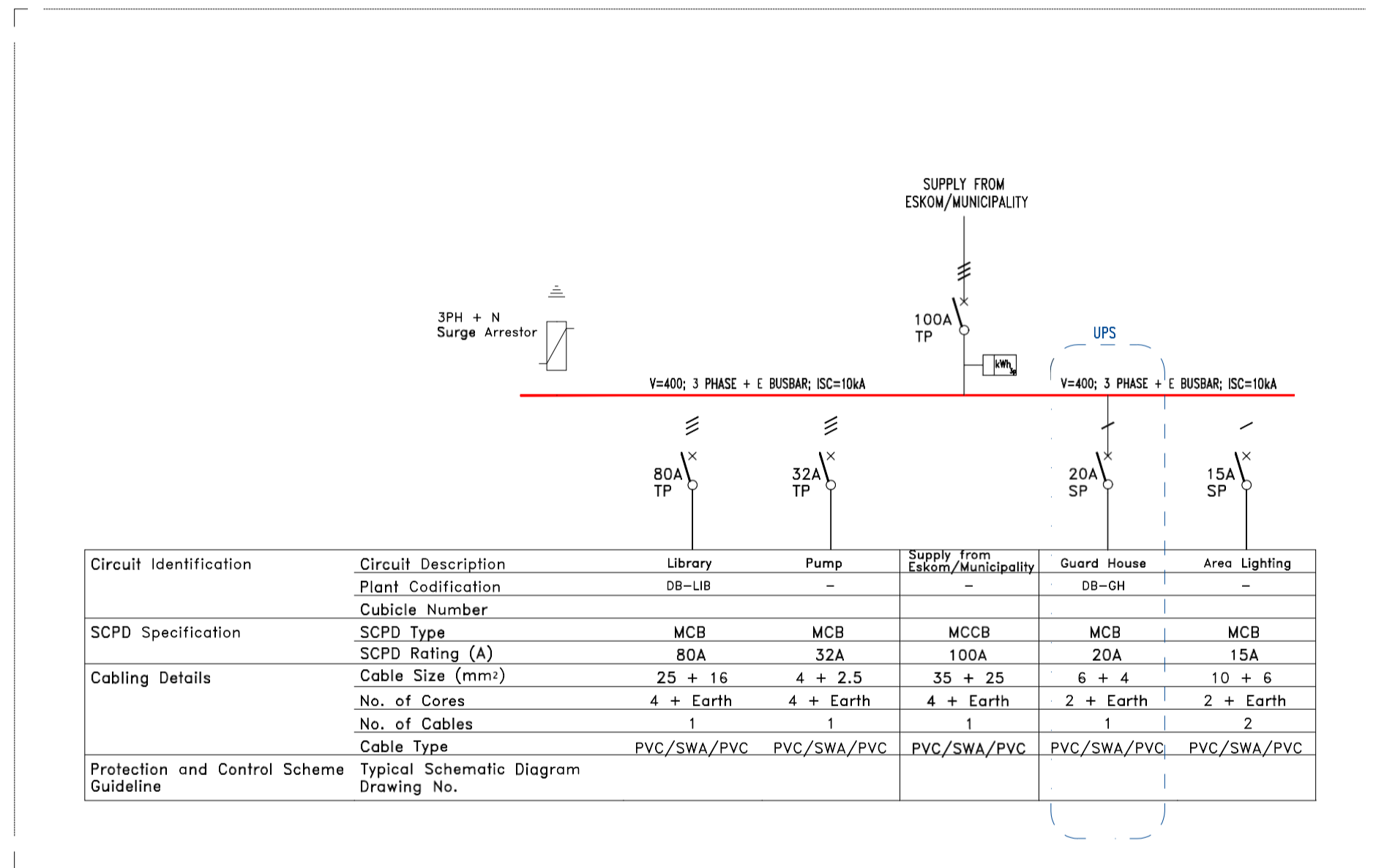

Circuit Identification	Circuit Description	Library	Pump	Supply from Eskom/Municipality	Guard House	Area Lighting
	Plant Codification	DB-LIB	-	-	DB-GH	-
	Cubicle Number					
SCPD Specification	SCPD Type	MCB	MCB	MCCB	MCB	MCB
	SCPD Rating (A)	80A	32A	100A	20A	15A
Cabling Details	Cable Size (mm ²)	25 + 16	4 + 2.5	35 + 25	6 + 4	10 + 6
	No. of Cores	4 + Earth	4 + Earth	4 + Earth	2 + Earth	2 + Earth
	No. of Cables	1	1	1	1	2
	Cable Type	PVC/SWA/PVC	PVC/SWA/PVC	PVC/SWA/PVC	PVC/SWA/PVC	PVC/SWA/PVC
Protection and Control Scheme Guideline	Typical Schematic Diagram Drawing No.					

BOARD PROPERTIES	
Type	Floor Standing
Material	-
IP Rating	46
Depth	-
Colour	Gray
Panels	2
Tray Size	-
Doors	Yes
Access	Front
Cable Entry	Bottom
Cable Exit	Bottom
Cascading Labels	Yes

QTY	DESCRIPTION	FAULT LEVEL
THREE PHASE BREAKERS		
1x	Floor standing board with lockable door, filled and wired with the following equipment:	
1x	100A TP	10kA
1x	80A TP	
1x	32A TP	
1x	5kA Surge Arrestor	
-	-	
-	-	
SINGLE PHASE BREAKERS		
1x	15A SP	
1x	10A SP	10kA
-	-	
-	-	

STATUS CODE	Group Codes BUILDINGS	DRAWING STATUS
0 - Pre - Feasibility study	BP - Building IT	FOR TENDER
1 - Feasibility study	BP - Building Public Address	PROJECT NUMBER
A - Preliminary Design	BS - Building Service	0283 - VL - TCS
B - Design Review	BA - Building Architectural	
C - Tender Design	BE - Building Electrical	Drawn By
D - Detailed Design	BF - Building Fire Service	Designed By
E - For Construction	BM - Building Mechanical	Reviewed/Approved By
F - As Built	BT - Building Public Telecoms	Name
G - For Information Only	BU - Building Public Utilities	Name

No	Date	chkd	Details
A	08.09.2021	EM	FOR TENDER

CLIENT

DEPARTMENT OF PUBLIC WORKS, ROADS & INFRASTRUCTURE

CONSULTANT

TAKUSA HOUSE, 17a MAGAZYN STREET, POLOKWANE, 0699
Tel: 015 291 2154 Fax: 086 659 2099
Email: engage@takusaconsulting.co.za

PROJECT

LIMPOPO NEW LIBRARIES PROJECT "VLEIFONTEIN LIBRARY"

DRAWING TITLE

LIBRARY MAIN KIOSK SINGLE LINE DIAGRAM LAYOUT

Project code	Status	Group	Consultant	Doc Type	Seq No	Rev
VL - C - BE - TCS - TDW - 003/1/1 - A						
SCALE						NTS
CHECKED						A
REV. No						
DATE						08.09.2021

01 02 03 04 05 06 07 08 09 10 11

A

A

B

B

C

C

D

D

01 02 03 04 05 06 07 08 09 10 11



- STATUS CODE**
- 0 - Pre - Feasibility study
 - 1 - Feasibility study
 - A - Preliminary Design
 - B - Design Review
 - C - Tender Design
 - D - Detailed Design
 - E - For Construction
 - F - As Built
 - G - For Information Only

- Group Codes**
- BP - Building IT
 - BP - Building Public Adress
 - BS - Building Service
 - BA - Building Architectural
 - BE - Building Electrical
 - BF - Building Fire Service
 - BM - Building Mechanical
 - BT - Building Public Telecoms
 - BU - Building Public Utilites

DRAWING STATUS

FOR TENDER

PROJECT NUMBER

0283 - VL - TCS

Drawn By

M CHABALALA

Name

Designed By

P ANNE

Name

Reviewed/Approved By

E MENSAB

Name

PI Number

20100414

Signature

CLIENT

CONSULTANT

PROJECT

TAKUSA HOUSE,

LIMPOPO NEW LIBRARIES PROJECT
VLEIFONTEIN LIBRARY

17a MAGAZYN STREET,
POLOKWANE,
0699

Tel: 015 291 2154
Fax: 086 659 2099

Email: engage@takusaconsulting.co.za

DRAWING TITLE

**LIBRARY FLOOR PLAN
TRUNKING LAYOUT**

Project code	Status	Group	Consultant	Doc. Type	Seq. No.	Rev
VL - C - BE - TCS - TDW - 005/1 - A						
SCALE						1:100
CHECKED						A
REV. No						
DATE						08.09.2021

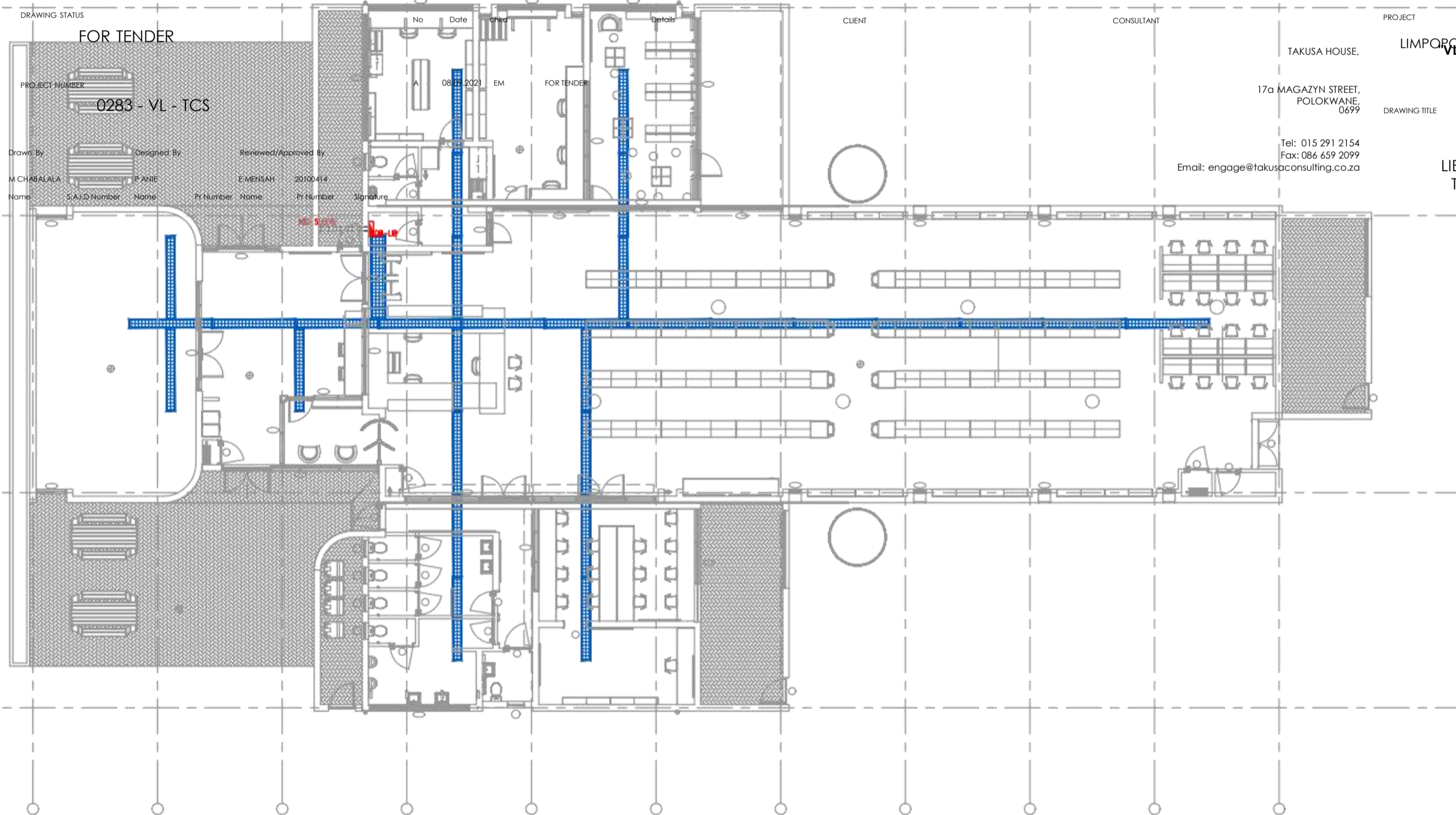

LEGEND

Item	Description	Qty
■	Electrical Distribution Board	01
----	#50/#75/#110mm PVC/Corrugated sleeve	lot
■	3000x300x50mm Heavy duty trunking	30
■	3000x500x50mm Heavy duty trunking	01

LIMPOPO
 PROVINCIAL GOVERNMENT
 REPUBLIC OF SOUTH AFRICA
 DEPARTMENT OF
PUBLIC WORKS, ROADS & INFRASTRUCTURE

TAKUSA
 CONSULTING PTY LTD

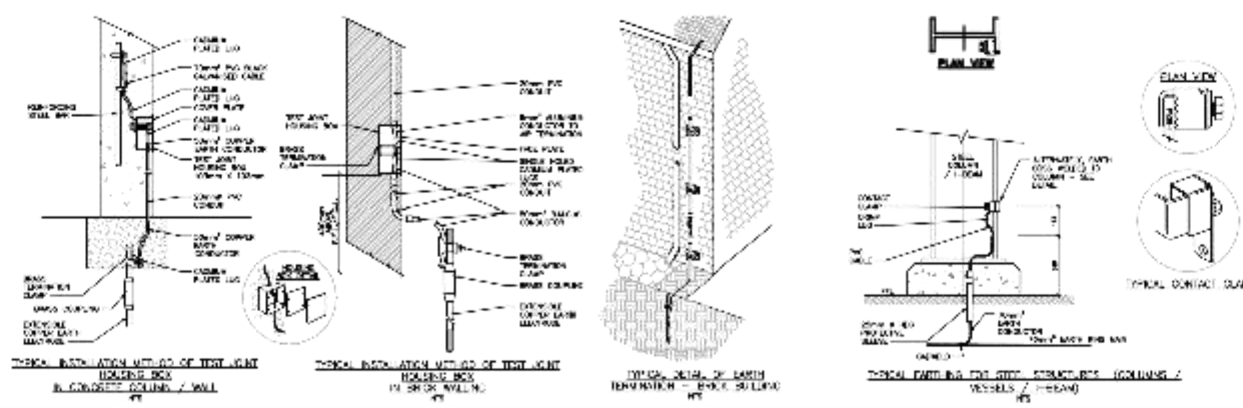
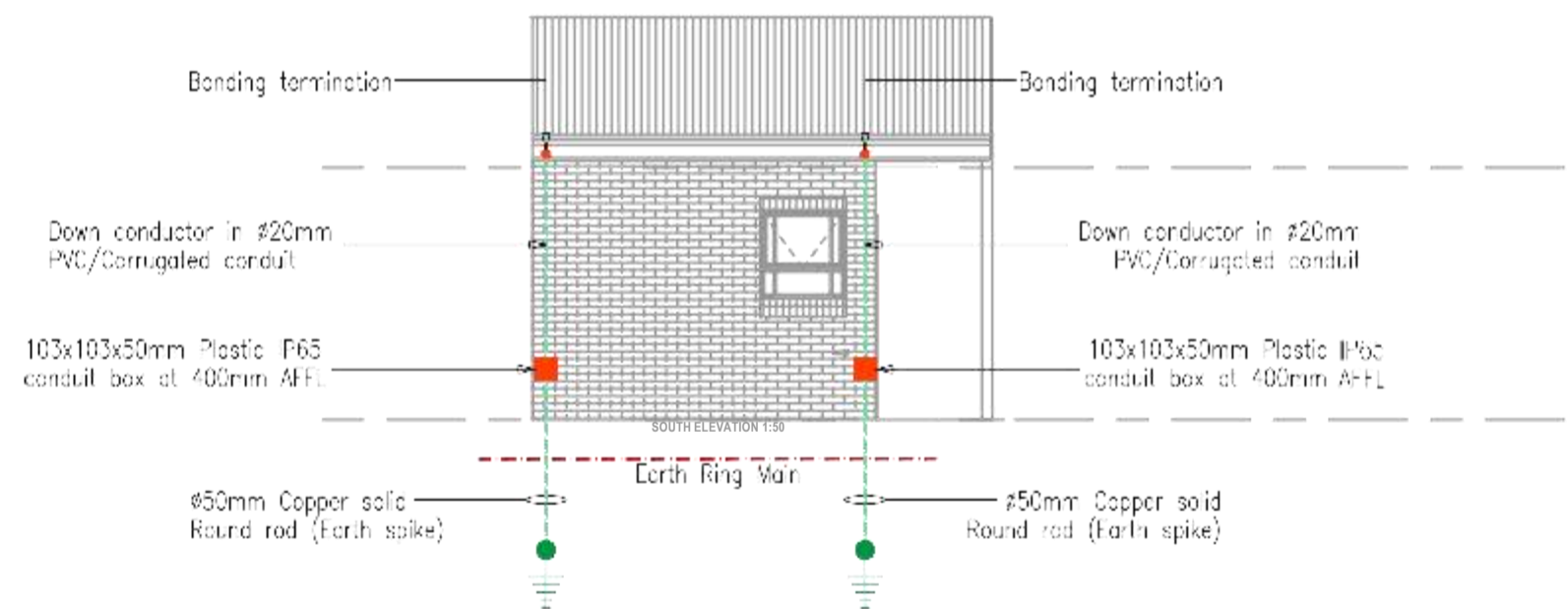
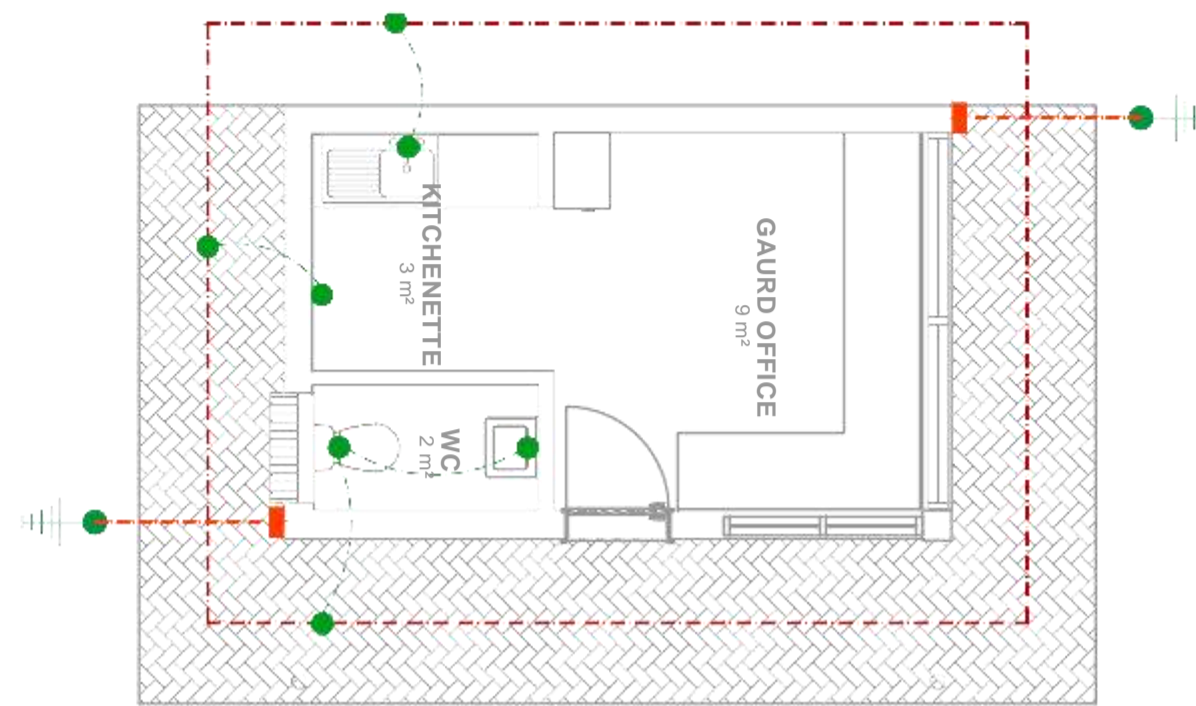

SYMBOL	DESCRIPTION
	EARTH RING MAIN
	DOWN CONDUCTOR
	EARTHING ROD
	EARTH ELECTRODE (SPIKE)
	BONDING TERMINATION
	EARTHING TEST POINT

GENERAL NOTES:

- EARTH TERMINATION CONDUCTOR TO BE 20MM² BARE.
- BONDING CONDUCTOR TO BE 16MM² BARE.
- EARTH ELECTRODE (SPIKE) TO BE 4.5m x 1.5m LONG COPPER SOLID ROUND BAR AND MUST BE 200 BURIED BELOW GROUND LEVEL.
- EARTH CONDUCTOR TO BE 0.5m BURIED BELOW GROUND LEVEL.

EARTH TERMINATION NOTES:

EARTH TERMINATION SYSTEM GENERAL REQUIREMENTS

- TYPE B EARTHING ARRANGEMENT SHALL BE USED FOR ANY BUILDING INSTALLATION.

THE RING EARTH ELECTRODE (TYPE B ARRANGEMENT) SHOULD PREFERABLY:

- BE BURIED AT A DEPTH OF AT LEAST 0.5m AND
- AT A DISTANCE OF ABOUT 1.5m AWAY FROM THE EXTERNAL WALLS UNLESS STATED OTHERWISE.

- THE CALCULATION OF AN EARTH TERMINATION SYSTEM SHALL BE DONE IN ACCORDANCE WITH THE FORMULAE IN SANS 10186.

DOWN CONDUCTOR NOTES:

- DOWN CONDUCTORS MUST BE INSULATED BY AT LEAST 3mm CROSS LINKED POLYETHYLENE.
- WARNING NOTICES TO BE INSTALLED TO AVOID THE PROBABILITY OF DOWN CONDUCTORS BEING TOUCHED.

EARTHING TEST POINT:

- EARTHING TEST POINT SHOULD BE CAPABLE OF BEING OPENED WITH THE AID OF TOOL.

THE COMPLETE INSTALLATION MUST COMPLY TO THE FOLLOWING SANS SPECIFICATION:

- SANS 10186: THE WORKING OF BUILDINGS
- SANS 10186: PART 2: EARTHING SYSTEMS GENERAL PROVISIONS
- SANS 10186: PART 3: INSTALLATION OF EARTHING SYSTEMS
- SANS 10186: PART 4: DESIGN AND INSTALLATION OF AN EARTH ELECTRODE
- SANS 10186: THE PROTECTION OF STRUCTURES AGAINST LIGHTNING
- SANS 1063: EARTHING SYSTEMS GENERAL PROVISIONS

STATUS CODE	Group Codes BUILDINGS
0 - Pre-Feasibility study	BP - Building Public Address
1 - Feasibility study	BS - Building Service
A - Preliminary Design	
B - Design Review	F - As Built
C - Tender Design	G - For Information Only
D - Detailed Design	
E - For Construction	

DRAWING STATUS	
FOR TENDER	
PROJECT NUMBER	0283 - VI - TCS
BA - Building Architectural	BE - Building Electrical
BF - Building Fire Service	BM - Building Mechanical
BT - Building Public Telecoms	
BU - Building Public Utilities	

No	Date	chkd	Details
A	08.09.2021	EM	FOR TENDER

CLIENT

CONSULTANT

TAKUSA HOUSE,
17a MAGAZYN STREET,
POLOKWANE,
0699

Drawn By
Designed
Reviewed/Approved By

PROJECT

LIMPOPO NEW LIBRARIES PROJECT
VLEIFONTEIN LIBRARY

DRAWING TITLE

M CHABALALA
ANIE
MENGAM

P
E
20100414

Project code	Status	Group	Consultant	Doc Type	Seq No	Rev
VL C BE TCS TDW 004/2 A	Copyright Reserved					
Name	Number	Name	Pr	S.A.I.D Number	Number	Signature

Tel: 015 291 2154
Fax: 086 659 2099
Email:
engage@takusaco
nsulting.co.za

GUARD
HOUSE
FLOOR PLAN
EARTHING &
LIGHTNING
PROTECTION
LAYOUT

SCALE

CHECKEDREV. No

DATE

1:40

A

08.09.2021

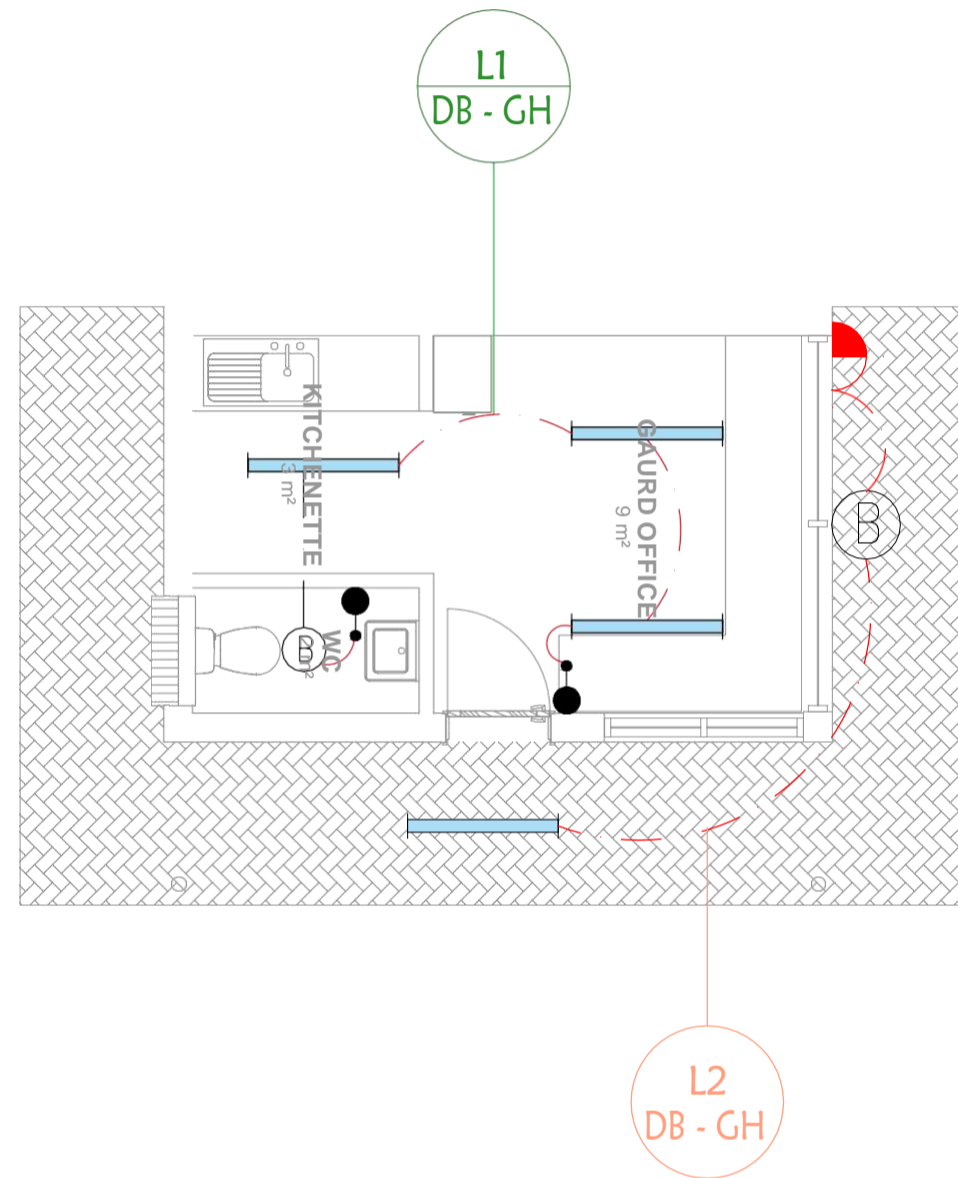

ITEM	LIGHTING LEGEND	QTY
	360 DEGREE MOTION SENSOR	00
	MOTION SENSOR	00
	16A SINGLE LEVER LIGHT SWITCH	02
	2-WAY 16A SINGLE LEVER LIGHT SWITCH	00
	2-WAY 16A DOUBLE LEVER LIGHT SWITCH	00
	TRIPLE LEVER LIGHT SWITCH	00
	MASTER KEY SWITCH	00
	DAYNIGHT SWITCH	01
	TYPE B 4 INCH 15W LED DOWNLIGHT WITH DALI MODIFICATION W/ WITH BATTERY BACKUP OF UP TO 120mins	00
	TYPE B 4 INCH 15W LED DOWNLIGHT WITH DALI MODIFICATION	00
	18W LED RONDRO DOWNLIGHT WITH DALI MODIFICATION	00
	18W LED RONDRO DOWNLIGHT WITH DALI MODIFICATION W/ WITH BATTERY BACKUP OF UP TO 120mins	00
	18W LED UP & DOWN FACING IP44 STAINLESS STEEL WALL LIGHT	00
	OMNISTAR 14LED015H OPTIC 1520 ASYMMETRICAL HIGH BAY LED	00
	LED STRIP	00
	15W LED ROUND BULKHEAD WITH DALI MODIFICATION	02
	VISUAL LED IP40 - 38W 1200x50mm WITH DALI MODIFICATION NW RECESSED	00
	VISUAL LED IP40 - 38W 1200x50mm WITH DALI MODIFICATION NW SUSPENDED LINEAR FITTING	00
	1200mm 36W LED IP66 CORROSION PROOF LIGHT FITTING WITH DALI MODIFICATION	00
	1200mm 36W LED IP66 CORROSION PROOF LIGHT FITTING WITH DALI MODIFICATION	04
	1200x600mm LED PANEL RECESSED LIGHT FITTING WITH BATTERY BACKUP OF UP TO 120mins	00
	1200x600mm LED PANEL RECESSED LIGHT FITTING WITH DALI MODIFICATION	00

STATUS CODE	Group Codes	DRAWING STATUS	No	Date	chkd	Details
	BUILDINGS	FOR TENDER	A	08.09.2021	EM	FOR TENDER
0 - Pre - Feasibility study	BP - Building IT	PROJECT NUMBER	0283 - VL - TCS			
1 - Feasibility study	BP - Building Public Address	Drawn By	M CHABALALA	Designed By	P ANIE	Reviewed/Approved By
A - Preliminary Design	BS - Building Service	Name	S.A.I.D Number	Name	Pr Number	Name
B - Design Review	BA - Building Architectural					
C - Tender Design	BE - Building Electrical					
D - Detailed Design	BF - Building Fire Service					
E - For Construction	BM - Building Mechanical					
F - As Built	BT - Building Public Telecoms					
G - For Information Only	BU - Building Public Utilities					

CLIENT	CONSULTANT	PROJECT
 LIMPOPO PROVINCIAL GOVERNMENT REPUBLIC OF SOUTH AFRICA DEPARTMENT OF PUBLIC WORKS, ROADS & INFRASTRUCTURE	 TAKUSA CONSULTING SERVICES	LIMPOPO NEW LIBRARIES PROJECT "VLEIFONTEIN LIBRARY"
17a MAGAZYN STREET, POLOKWANE, 0699 Tel: 015 291 2154 Fax: 086 659 2099 Email: engage@takusaconsulting.co.za	DRAWING TITLE GUARD HOUSE FLOOR PLAN LIGHTING LAYOUT	SCALE 1:40 CHECKED A REV. No DATE 08.09.2021

PROJECT CODE VL - C - BE - TCS - TDW - 002/2 - A	CONSULTANT TAKUSA CONSULTING SERVICES	PROJECT LIMPOPO NEW LIBRARIES PROJECT "VLEIFONTEIN LIBRARY"	Project code VL - C - BE - TCS - TDW - 002/2 - A	Consultant TAKUSA CONSULTING SERVICES	Doc Type A	Seq No A	Rev A
SCALE 1:40	CHECKED A	REV. No A	DATE 08.09.2021	SCALE 1:40	CHECKED A	REV. No A	DATE 08.09.2021

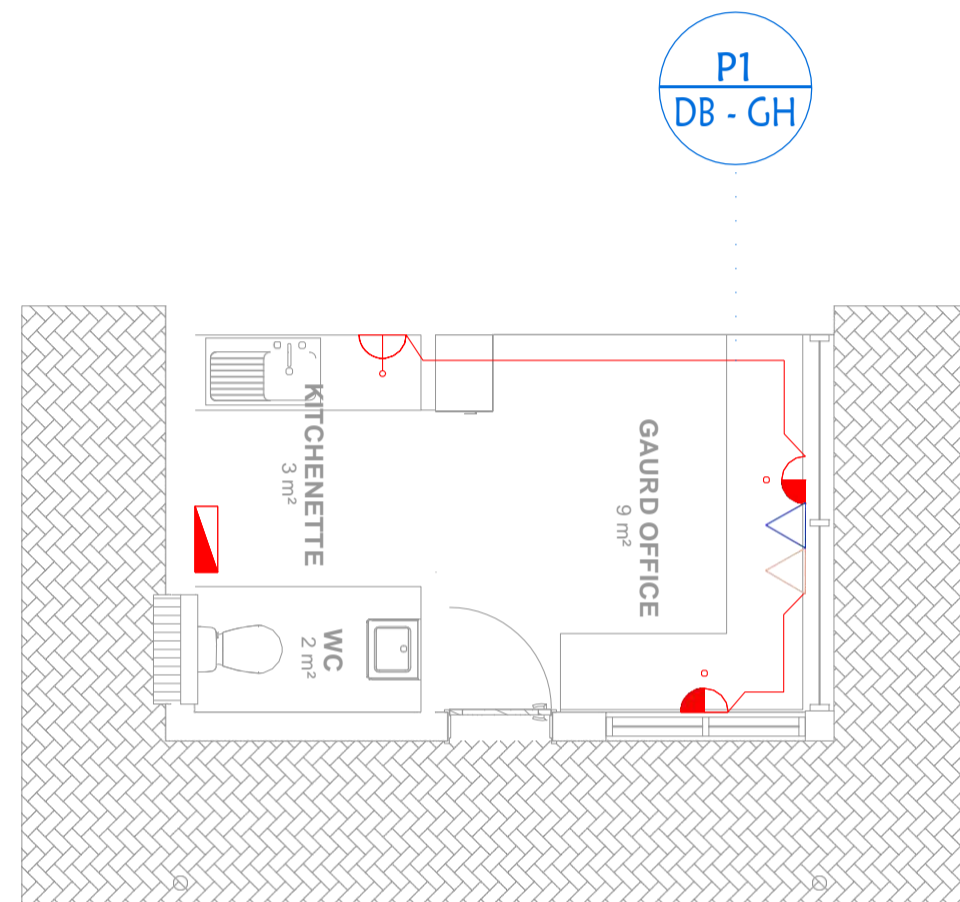

POWER LEGEND	
ITEM	DESCRIPTION
	TV POINT
	TELEPHONE POINT
	DATA POINT
	SINGLE PHASE ISOLATOR
	THREE PHASE ISOLATOR
	THREE PHASE INDUSTRIAL SOCKET OUTLET @1200 A.F.F.L
	SINGLE 16A DEDICATED SOCKET OUTLET @300 A.F.F.L
	SINGLE 16A 2A PLUG SOCKET OUTLET @1200 A.F.F.L
	SINGLE SOCKET OUTLET C/W EURO 3 PIN, 2x USB POINTS @300 A.F.F.L
	SINGLE 16A 2A PLUG SOCKET OUTLET @300 A.F.F.L
	DOUBLE 16A 2A PLUG SOCKET OUTLET @300 A.F.F.L
	DOUBLE 16A 2A PLUG SOCKET OUTLET @1200 A.F.F.L
	POWER SKIRTING
	POWER SKIRTING INSTALLED SUPPORTED AT TRUSS LEVEL
	PEDestal FOR MEETING/PRESENTER'S TABLE CONSISTING OF THE FF: - 16A NORMAL SOCKET UN-SWITCHED - 16A DEDICATED SOCKET UN-SWITCHED - 2x USB POINTS
	ONE TIER CLUSTER WALL BOX CONSISTING OF THE FOLLOWING: - 16A NORMAL SOCKET UN-SWITCHED - 16A DEDICATED SOCKET UN-SWITCHED - 2x USB POINTS
	ELECTRICAL DISTRIBUTION BOARD

STATUS CODE	Group Codes BUILDINGS
0 - Pre - Feasibility study	BP - Building IT
1 - Feasibility study	BP - Building Public Address
A - Preliminary Design	BS - Building Service
B - Design Review	SA - Building Architectural
C - Tender Design	BE - Building Electrical
D - Detailed Design	BF - Building Fire Service
E - For Construction	BM - Building Mechanical
F - As-Built	BT - Building Public Telecoms
G - For Information Only	BU - Building Public Utilities

DRAWING STATUS	
FOR TENDER	
PROJECT NUMBER	0283 - VL - TCS
Drawn By	M-CHABALALA
Designed By	P-ANIE
Reviewed/Approved By	E-MENSAH
Name	S.A.I.D Number
Name	Pr Number
Name	Pr Number
Name	Pr Number
Signature	

No	Date	chkd	Details
A	08.09.2021	EM	FOR TENDER

CLIENT

PROVINCIAL GOVERNMENT
REPUBLIC OF SOUTH AFRICA

DEPARTMENT OF
PUBLIC WORKS, ROADS & INFRASTRUCTURE

CONSULTANT

TAKUSA HOUSE,
17a MAGAZYN STREET,
POLOKWANE,
0699
Tel: 015 291 2154
Fax: 086 659 2099
Email: engage@takusaconsulting.co.za

PROJECT

LIMPOPO NEW LIBRARIES PROJECT
"VLEIFONTEIN LIBRARY"

DRAWING TITLE

**GUARD HOUSE FLOOR PLAN
POWER LAYOUT**

Project code	STATUS	Consultant	Doc Type	Seq No	Rev
VL - C - BE - TCS - TDW - 001/2 - A					
SCALE					1:40
CHECKED					A
REV. No					
DATE					08.09.2021

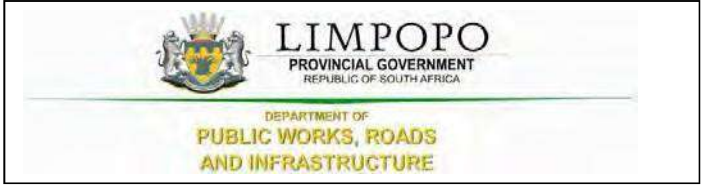

PART C7.2. 3: MECHANICAL SPECIFICATIONS AND DRAWINGS



LIMPOPO

PROVINCIAL GOVERNMENT
REPUBLIC OF SOUTH AFRICA

DEPARTMENT OF PUBLIC WORKS, ROADS & INFRASTRUCTURE

PROJECT NAME NEW LIBRARIES FOR THE LIMPOPO DEPARTMENT OF SPORTS, ART AND CULTURE (DSAC) AT THE FOLLOWING LOCATIONS: BOTSHABELO (WATERBERG DISTRICT), TSHAULU (VHEMBE DISTRICT), SEKHUKHUNE DISTRICT AND VLEIFONTEIN (VHEMBE DISTRICT)

LIBRARY NAME ALL SITES

PROJECT NO. LDPWRI-PROF/18005

DOCUMENT TITLE SPECIFICATIONS FOR MECHANICAL INSTALLATIONS

PART NUMBER 2 – GENERAL SPECIFICATIONS

REVISION 00

EMPLOYER	CONSULTING ENGINEERS
LIMPOPO DEPARTMENT OF PUBLIC WORKS AND INFRASTRUCTURE 43 CHURCH STREET POLOKWANE 0700	SUPERIOR QUALITY ENGINEERING AND TECHNOLOGIES 60 MAGAZYN STREET POLOKWANE 0699

SEPTEMBER 2021

	New Libraries for the Limpopo Department of Sports, Art and Culture (DSAC) Library Name: LDPWRI-PROF/18005	Rev	00
		SQET File	
		ECSA Stage	4
		Discipline	Mechanical

DOCUMENT CONTROL

Project Name	New Libraries for the Limpopo Department of Sports, Art and Culture (DSAC) at the following locations: Botshabelo (Waterberg District), Tshaulu (Vhembe District), Sekhukhune district and Vleifontein (Vhembe District)
Project Number	LDPWRI-PROF/18005
Library Name	-
Client Name	New Limpopo Department of Public Works and Infrastructure

ECSA Project Stage	Stage 4: Specifications
Document Type	Specifications For Mechanical Installations
Part Number	2 – General Specifications
Installations	Mechanical
SQET File Number	

	COMPILED	REVIEWED	SIGNED	APPROVED
NAME	T. C Mango	T. Magada	B. Nyambiya	
ORGANISATION	SQET	SQET	SQET	
DESIGNATION	Lead Engineer	Project Engineer	Principal Engineer	
DATE	06 September 2021	07 September 2021	09 September 2021	

	New Libraries for the Limpopo Department of Sports, Art and Culture (DSAC) Library Name: LDPWRI-PROF/18005	Rev	00
		SQET File	
		ECSA Stage	4
		Discipline	Mechanical

GENERAL SPECIFICATIONS FOR MECHANICAL INSTALLATIONS

PART 2

	New Libraries for the Limpopo Department of Sports, Art and Culture (DSAC) Library Name: LDPWRI-PROF/18005	Rev	00
		SQET File	
		ECSA Stage	4
		Discipline	Mechanical

SPECIFICATIONS FOR MECHANICAL INSTALLATIONS

PART 2

Contents

SCOPE OF WORKS	Error! Bookmark not defined.
REGULATIONS EMPLOYED	Error! Bookmark not defined.
1. NOTICE	5
2. STANDARD MEASURES.....	5
3. MATERIALS AND WORKMANSHIP.....	5
4. DRAWINGS	6
5. SITE CONDITIONS	8
6. DEVIATIONS FROM BID DOCUMENTS.....	8
7. PROGRAMMING OF WORK	8
8. MANUFACTURER’S RATINGS.....	8
9. NOTICES	9
10. GUARANTEE	9
11. LUBRICATION	9
12. COMMISSIONING AND TESTING	9
13. PERFORMANCE TOLERANCE	11
14. TEST CERTIFICATES.....	12
15. APPLICATION FOR INSTALLATION	12
16. POWER, WATER AND DRAIN CONNECTIONS.....	12
17. QUALITY OF MATERIALS.....	12
18 .SERVICE ACCESS	13
19. STANDARD SPECIFICATIONS	13
20. KYOTO PROTOCOL.....	13
21. GENERAL MAINTENANCE AND SERVICING	14
22. MAINTENANCE INSTRUCTION OF OWNER’S STAFF	14
23. SPARE PARTS AND AGENCIES.....	14
24. TOOLS.....	15
25. OPERATING, MAINTENANCE INSTRUCTIONS, WIRING AND CONTROL DIAGRAMS.....	15
SECTION 1: System Description.....	16

	New Libraries for the Limpopo Department of Sports, Art and Culture (DSAC) Library Name: LDPWRI-PROF/18005	Rev	00
		SQET File	
		ECSA Stage	4
		Discipline	Mechanical

SECTION 2: Commissioning Data	16
SECTION 3: Operating Instructions	16
SECTION 4: Mechanical Equipment	16
SECTION 5: Maintenance Instructions	16
SECTION 6: Electrical Equipment	17
SECTION 7: Instrumentation and Control	17
SECTION 8: Drawings.....	17
26. EQUIPMENT TO BE USED WHEN ERECTING INSTALLATION	17
27. ASSEMBLY OF COMPONENTS	17
28. WELDING.....	18
29. GALVANIZING.....	18
30. PAINTING.....	20
31. ERECTION OF EQUIPMENT.....	21
a. Equipment Plinths.....	22
b. Clamping Down Bolts and Bolts for Equipment.....	22
c. Vibration Isolation.....	23
d. Damping.....	23
32. ELECTRICAL EQUIPMENT AND INSTALLATION	23
33. SELECTION OF EQUIPMENT	24
34. HEAT PUMPS.....	Error! Bookmark not defined.
1. FIRE HOSE REEL	Error! Bookmark not defined.
2. FIRE EXTINGUISHERS.....	Error! Bookmark not defined.
3. HEAT PUMP.....	Error! Bookmark not defined.
4. FIRE EXTINGUISHERS.....	Error! Bookmark not defined.

	New Libraries for the Limpopo Department of Sports, Art and Culture (DSAC) Library Name: LDPWRI-PROF/18005	Rev	00
		SQET File	
		ECSA Stage	4
		Discipline	Mechanical

GENERAL REQUIREMENTS

1. NOTICE

- 1.1 This Standard Specification forms part of, and is to be read on conjunction with the Supplementary Specifications for the Mechanical Installations.
- 1.2 In so far as the conditions herein contained are at variance with anything contained in the supplementary specifications, the contract shall be in terms of the Supplementary Specifications for each particular service.
- 1.3 Where reference is made to “Contractor” or “Sub-Contractor”, it shall be read to mean the successful Bidder appointed to execute the contract specified in the Supplementary Specification

2. STANDARD MEASURES

- 2.1 The dimensions, weights, etc., shown on the drawings and mentioned in the specifications shall be taken as the Republic of South Africa’s legal standard weights and measures.

3. MATERIALS AND WORKMANSHIP

- 3.1 All work is to be executed with materials of the best quality and in the most substantial manner under the inspection and to the entire satisfaction of the Engineer.
- 3.2 The entire installation shall be in accordance with the following:
 - a. The national Building Regulations and Building Standards Act No. 103 of 1977 as amended in 1984 and all amendments thereafter.
 - b. The latest revision of SABS 0400: The Applications of the National Building Regulations, as amended.
 - c. SABS Code of Practice for the Wiring of Premises No. 0142 of 1981, as amended.
 - d. The Machinery and Occupational Health and Safety Act No. 85 of 1993.
 - e. Any other relevant by-laws of local or other authorities.
- 3.3 All apparatus, components, parts, fitting and materials supplied and/or installed whether especially specified herein or not shall conform in respect of quality, manufacture, tests and performance with the requirements of the appropriate current South African (SABS) or British Standard Specifications (BS) and Addenda thereto, except where otherwise required by this specification or permitted by approval of the Engineer in writing. All materials and

	New Libraries for the Limpopo Department of Sports, Art and Culture (DSAC) Library Name: LDPWRI-PROF/18005	Rev	00
		SQET File	
		ECSA Stage	4
		Discipline	Mechanical

workmanship which may, in the opinion of the Engineer be inferior to that specified for the work will be condemned. All condemned material and workmanship must be replaced or rectified as the case may be, to the satisfaction of the Engineer.

- 3.4 No second-hand equipment of any description may be offered for supply or installation.
- 3.5 If so required, the Engineer may call for samples of material and equipment for approval. Such samples shall be submitted within 14 days of the request and if judged necessary by the Engineer may only be returned after completion of the installation in order to ensure that the quality of the installed product is the same as that of the approved sample.
- 3.6 Any fitting or item of equipment not specifically mentioned but obviously necessary for the successful completion of the installation is to be included so as to form a complete working installation.

4. DRAWINGS

- 4.1 The bid drawings issued with the Supplementary Specification are schematic and do not necessarily purport to show the exact position, size or details of construction of equipment.
- 4.2 Bidders must satisfy themselves that the equipment offered by them can be accommodated in the available space and positioned in such a way that access for maintenance, repairs or removal is not obstructed.
- 4.3 Contractor's drawings: Where indicated in the Supplementary Specification these drawings are to be prepared by the Contractor at his/her expense in accordance with this document and shall be on a scale of not less than 1:50. These drawings shall at least consist of:
 - a. Builder's work drawings: These shall indicate all work to be done by others (bases, foundations, holes in concrete and masonry, etc.) as well as the sizes, capacities and positions of service connections (electrical, water, drainage, etc.) to be provided by others, all in accordance with the supplementary specification.
 - b. General arrangement drawings: These shall indicate all equipment, distribution systems, testing and inspection requirements as well as instrumentation positions and access requirements. During their preparation, the Contractor shall take cognisance of all relevant architectural, structural, electrical and other service drawings in order to properly co-ordinate his/her layout. These drawings can be obtained via the Engineer. The drawings shall be amended as required during the contract period, and up to date copies kept on site for reference purposes.
- 4.4 Positions and sizes of air grilles, louvered openings through reinforced concrete beams and slabs, etc., as indicated on the bid drawings shall be adhered to as far as possible. Amendments will only be considered if absolutely unavoidable.

	New Libraries for the Limpopo Department of Sports, Art and Culture (DSAC) Library Name: LDPWRI-PROF/18005	Rev	00
		SQET File	
		ECSA Stage	4
		Discipline	Mechanical

- a. Shop drawings: These shall be based on the General Arrangement drawings, and shall show in detail the construction of all the parts of the works, method of assembly where applicable, erection and construction materials and connections, welds, gaskets, sealants, fastenings, reinforcing and all other necessary detail.
 - b. Electrical Drawings: Electrical drawings shall comprise complete control and power wiring diagrams, as well as front and side elevations giving major dimensions of control panels as well as instrumentation and switch position layouts.
 - c. As-Built drawings and wiring diagrams: These are up-to-date approved drawings at the completion of the contract. Bidders shall allow in their price for submitting to the Engineer a set of each of the up-to-date general arrangement drawings, shop drawings, as well as electrical drawings together with the O&M manuals specified herein.
- 4.5 Submission of contractor's drawings: Drawings shall be submitted to the Engineer in an orderly fashion commencing within the following time limits or as determined by the main contract programme (where applicable):

Builders work drawings	:	within 2 weeks of bid acceptance.
General layout drawings	:	within 4 weeks of bid acceptance.
Shop drawings	:	within 6 weeks of bid acceptance.
Electrical drawings	:	within 6 weeks of bid acceptance.
As-built drawings	:	at completion before first hand-over.

By submitting drawings, the Contractor represents that he/she has determined and verified all site measurements, site instruction criteria, materials, catalogue numbers and similar data, or will do so, and that he/she has checked and co-ordinated each of his/her drawings with the requirements of the works and the contract documents, taking into account drawings of all other relevant disciplines. At the time of submission, the Contractor shall inform the Engineer in writing of any deviation in the Contractor's drawings from the requirements of the supplementary documents. After scrutiny the Engineer may at his/her discretion and depending on the number of discrepancies, requires amendment and resubmission prior to approval. Drawings shall be resubmitted until approved prior to any portion of the works related to the drawings being commenced. Should the Contractor, during drawing amendment, alter any portion of his/her drawings not specifically required by the Engineer, he/she shall point this out in writing when resubmitting the drawing. Approval of the Contractor's drawings in no way indemnifies him/her from being responsible for the correctness of the drawings and satisfactory operation of the installation.

- 4.6 If the Bidder wishes to submit alternative proposals, differing from the Engineer design, drawings indicating such proposals comprehensively shall be submitted with this Bid.

	New Libraries for the Limpopo Department of Sports, Art and Culture (DSAC) Library Name: LDPWRI-PROF/18005	Rev	00
		SQET File	
		ECSA Stage	4
		Discipline	Mechanical

5. SITE CONDITIONS

5.1 It is the responsibility of the Bidder to visit the site during the bid phase and to familiarise himself/herself with conditions related to it. If the location of the site is not indicated in the Supplementary Specification, it can be obtained from the Engineer. No claim for additional payment related to ignorance of site conditions will be accepted. By submitting a bid, it is accepted that the Bidder is fully aware of all site conditions as well as the access to it, and has allowed for this in his/her bid price.

6. DEVIATIONS FROM BID DOCUMENTS

6.1 No deviations or alterations from that of the specification, schedules or drawings shall be made without first obtaining the written approval of the Engineer.

7. PROGRAMMING OF WORK

- 7.1 The contract works shall proceed concurrently with the building construction or in accordance with an approved programme in all respects.
- 7.2 It is essential that the Contractor programmes his/her construction and all other work in conjunction with the Main Contractor and the main contract programme in order to avoid possible delays or clashes of trades.
- 7.3 For direct contracts the Contractor shall submit a detailed programme in the form of a bar chart based on the contract period and the various activities and components of the installation. This programme shall be submitted to the Engineer within two weeks of site hand-over.

8. MANUFACTURER'S RATINGS

- 8.1 All equipment such as fans, compressors, cooling towers, pumps, etc. shall be selected to be operated well within the manufacturer's ratings. Equipment offered for use beyond these limits will not be considered.
- 8.2 Bidders must submit manufacturer's ratings of all equipment offered. Ratings shall be given in the SI system.

	New Libraries for the Limpopo Department of Sports, Art and Culture (DSAC) Library Name: LDPWRI-PROF/18005	Rev	00
		SQET File	
		ECSA Stage	4
		Discipline	Mechanical

9. NOTICES

9.1 The Contractor shall supply and install all notices and warning signs that are required by the appropriate laws or regulations and by these documents.

10. GUARANTEE

- 10.1 The 12-month guarantee called for in the Supplementary Specification, shall apply to all items of plant related to the HVAC installations delivered to site and/or erected. It is the responsibility of the Contractor to negotiate with his/her suppliers in order to secure their equipment guarantee on this basis.
- 10.2 The date of acceptance shall be that appearing in the acceptance certificate issued by the Engineer and shall define the start of the guarantee period and free maintenance period (where applicable).
- 10.3 No Claims for extended guarantee or otherwise from Suppliers, Principals, etc., will be considered even if equipment is required on site long before acceptance date.

11. LUBRICATION

11.1 All bearings must be packed with approved grease or filled with the correct oil, and all gearboxes and sumps must be filled with the lubricant specified by the manufacturer. The Contractor will be responsible for the supply of all lubricants required for the initial fill. All lubricants must be new and supplied in sealed drums or containers.

12. COMMISSIONING AND TESTING

- 12.1 Commissioning Engineers - The Bidder shall allow in his/her Bid price for the services of approved and expert Commissioning Engineers, as may be appropriate for the individual specialised sections of his/her contract, as well as a competent Engineer in overall control of the installation. Testing and commissioning shall be carried out by these Engineers. Should undue problems be encountered at any time, the Contractor may be requested by the Engineer to obtain the services of a representative of the manufacturer of specified items of equipment, at no cost to the Engineer.
- 12.2 Notice of Testing and Commissioning - The Engineer shall receive not less than two weeks advance notice of any tests to be witnessed by the Engineer.

	New Libraries for the Limpopo Department of Sports, Art and Culture (DSAC) Library Name: LDPWRI-PROF/18005	Rev	00
		SQET File	
		ECSA Stage	4
		Discipline	Mechanical

- 12.3 Failure of Works, Site or Commissioning Tests - Should the Engineer be notified to attend official tests as laid down, and should the equipment fail the test for any reason whatsoever, such that the Engineer is required to re-witness the test, the time, transport and disbursement by the Engineer in so doing will be for the Contractor's account, which amount may be deducted at the option of the Engineer from monies due to the Contractor.
- 12.4 Quality Testing of Equipment - The Engineer reserves the right to arrange for testing of any piece of equipment at will, to check on compliance with the relevant specifications. Should the particular piece of equipment pass the test, the cost of such testing will be borne by the Client. However, should it fail the test, the cost of the test, rectification of the shortcomings, re-testing and repetition of the same test on the remaining like items will be for the Contractor's account.
- 12.5 Inspection during Manufacture - The Contractor will advise the Engineer when the items to be supplied are in the course of manufacture. The Engineer reserves the right to inspect any items during the course of manufacture and witness any performance tests that may be required thereon. The Contractor shall give the Engineer at least two weeks advance notice of work tests.
- 12.6 Testing - The Contractor shall be responsible for carrying out all tests laid down in the specific sections elsewhere in this document, in addition to those listed hereafter and in the Supplementary Specification. Testing and balancing shall not begin until the system has been completed and is in full working order. The plant shall be tested and operated to meet the performance figures and duties specified. All safety features and interlocks will be tested. The Contractor will be responsible for all costs incurred in the testing, including the supply, calibration and use of all instruments and tools, but not the supply of water or power on site. All instruments and test equipment used shall be provided by the Contractor, and shall be accurately calibrated and maintained in good working order. All test instruments used for tests to be witnessed by the Engineer shall be provided with calibration certificates, which must be available to the Engineer.

Specific attention is drawn to the fact that calibration certificates will be required for the following:

- Watt meters, ammeters, voltmeters, frequency meters, pressure gauge, flow meters, orifices plates, temperature gauges and relative humidity meters.
- All instruments shall be of above standard grade, and test pressure gauges shall not be less than 150mm in diameter. The maximum scale of the instrument shall not exceed 1.5 times the full test requirement.
- It is essential that the Contractor inspects and tests all equipment before requesting the Engineer to inspect or witness acceptance tests thereon.
- All acceptances tests, whether in the manufacturers works or on site, must be carried out in the presence of the Engineer.

	New Libraries for the Limpopo Department of Sports, Art and Culture (DSAC) Library Name: LDPWRI-PROF/18005	Rev	00
		SQET File	
		ECSA Stage	4
		Discipline	Mechanical

- Should the Engineer wish to verify the calibration of any instruments, the Contractor shall make the necessary arrangements for the instrument to be re-calibrated by a recognised authority. Should the instrument prove to be correctly calibrated, the cost of the re-calibration test will be borne by the Client. Should the instrument prove to be in error, the cost of the tests will be borne by the Contractor.
- Two copies of the complete test reports shall be submitted to the Engineer, prior to the first delivery of the project. Reports shall cover all tests carried out on individual sections, including such works tests as may have been conducted. All reports shall be neatly types.

12.7 Commissioning - The Contractor shall carry out all tests and commissioning of the systems installed by him/her, in a co-ordinated and properly organised manner. Air Conditioning and Ventilation installations shall be commissioned in accordance with the following Codes or such other recognised commissioning procedure or code approved by the Department. Should the tests be carried out over an area outside the range of normal speech, it is required that the Contractor make available at least four batteries powered, two-way radio sets, to facilitate communications. The testing procedure shall be sufficiently comprehensive to prove the correct functioning of each and every piece of equipment, and its suitability for the application. After all systems and equipment have been tested and commissioned to the satisfaction of the Engineer, a detailed demonstration of all functions of the system shall be carried out in the presence of the Engineer, so as to allow him/her to become fully acquainted with the operation of the system. The commissioning tests shall include the tests laid down under the specific section's hereafter, and a full operational test of all pumps, compressors, fans and control gear in all modes of operation. The Contractor shall allow for the replacement and cost of any materials and fuel used for testing purposes, as part of the contract. The demonstration to the users shall include a repeat of the operational tests above. The planning of this demonstration shall take place in collaboration with the Engineer. A certificate of completion will not be issued until all tests have been satisfactorily completed, and the plant has operated successfully, to the complete satisfaction of the Engineer.

13. PERFORMANCE TOLERANCE

All performance figures obtained during testing and commissioning must be within -5% and +5% of the specified performance figures given in the supplementary specification. Should the plant fail to comply with these figures after it has been tested and operated for a period of seven days, then the Contractor shall have a further four weeks to meet the requirements of the specification, after which the Engineer shall have the right to reject the plant and recover all monies paid to the Contractor for the rejected plant.

	New Libraries for the Limpopo Department of Sports, Art and Culture (DSAC) Library Name: LDPWRI-PROF/18005	Rev	00
		SQET File	
		ECSA Stage	4
		Discipline	Mechanical

14. TEST CERTIFICATES

The Contractor shall ensure that copies of all relevant test certificates, inspection reports, materials analysis certificates and similar data as may be required under various sections of this specification, or by Government Licensing and Inspection Authorities or Local Authorities, shall be provided before handing over the plant. Acceptance of the plant will be delayed if such certificates are not available. In particular, attention is drawn to pressure vessel and boiler construction and materials test certificates.

15. APPLICATION FOR INSTALLATION

The Contractor shall allow for the submission of the necessary forms, fees and drawings to the Inspector of Machinery or other relevant Authorities to obtain permission to install equipment where this is required. He shall also, in co-operation with the Engineer make any arrangements that may be required for Government Inspectors or other relevant inspectors to carry out prescribed tests.

16. POWER, WATER AND DRAIN CONNECTIONS

- 16.1 Power, water and drain points in the plant room will be provided by and at the expense of the Client.
- 16.2 All plumbing between equipment and water and drain points shall form part of this contract.
- 16.3 The exact details of terminal points will be set out in the Supplementary Specification.
- 16.4 Electrical supply shall terminate in an isolator, by Electrical Contractor, supply from this isolator to HVAC equipment by HVAC contractor.

17. QUALITY OF MATERIALS

- 17.1 Only new materials of high quality shall be used throughout and shall be subject to the approval of the Engineer.
- 17.2 All materials, where applicable, shall conform in respect of quality, manufacture, tests and performance, with the requirements of the SABS standards or, where no such standards exist, they shall conform to the appropriate current specification of the British Standard Institution. Materials manufactured in South Africa shall be used wherever possible.

	New Libraries for the Limpopo Department of Sports, Art and Culture (DSAC) Library Name: LDPWRI-PROF/18005	Rev	00
		SQET File	
		ECSA Stage	4
		Discipline	Mechanical

- 17.3 Imported materials shall comply with the requirements of the relevant SABS or British Standard Specifications, although these materials need not necessarily bear the SABS mark.
- 17.4 All materials shall be suitable for the particular site conditions. These conditions shall include weather conditions as well as prevailing conditions during installation and subsequent permanent use.
- 17.5 Should the materials or components not be suitable for use under temporary site conditions, where applicable, the Contractor shall provide at his/her own cost, suitable protection until these unfavourable site conditions cease to exist.

18. SERVICE ACCESS

- 18.1 Where equipment such as fans, dampers, etc. are installed in ceiling voids, the Contractor shall ensure that access will be possible for maintenance purposes after installation.

19. STANDARD SPECIFICATIONS

- 19.1 Unless otherwise specified in the supplementary specification, the following standard specifications (including amendments) of the organisations indicated shall form part of this specification.
- a. SABS 1125-1977 : Room air conditioners.
 - b. SABS 0140-1978 : Identification colour marking.
 - c. SABS 0139-1981 : The prevention, automatic detection and extinguishing of fire in buildings.
 - d. SABS 0147-1992: Refrigerating systems including plants associated with air conditioning systems.
 - e. SABS 1424-1987: Filters for air-conditioning and general ventilation.
- 19.2 Bidders shall indicate in their bid submission whether their bid and/or equipment as applicable complies with any of the above specifications or carries the SABS mark.

20. KYOTO PROTOCOL

Bids for equipment utilising chlorofluorocarbons (CFCs), hydrochlorofluorocarbons (HCFCs) or hydrofluorocarbons (HFCs), to be supplied and installed shall be within the constraints and schedules of the Kyoto Protocol and the Copenhagen Agreement and such amendments thereto as may be made by the international community. Where bids are submitted for equipment not complying with this Protocol it shall be clearly indicated, in writing, in the bid submission.

	New Libraries for the Limpopo Department of Sports, Art and Culture (DSAC) Library Name: LDPWRI-PROF/18005	Rev	00
		SQET File	
		ECSA Stage	4
		Discipline	Mechanical

21. GENERAL MAINTENANCE AND SERVICING

- 21.1 Unless otherwise specified in the Supplementary Specification, the Contractor shall be responsible for all maintenance and servicing of the installation for the full 12-month guarantee period. During this period, the Contractor shall make good any defect due to inferior materials or workmanship and maintain all plant and equipment in perfect operating condition.
- 21.2 The Contractor shall be entirely responsible for carrying out regular inspection at intervals not greater than 1 month, unless otherwise specified, and for full servicing of all components of the installation in accordance with the manufacturer's instructions. For this purpose, the Contractor shall prepare a detailed inspection and service report in the form of a checklist and log sheet showing all functions to be carried out at each inspection and service. Copies of these service reports shall be regularly submitted to the Engineer after each service.
- 21.3 The Contractor shall also maintain a plant log book on site in which he/she shall record, sign and date all work carried out at each inspection as well as log all temperatures and pressure readings, etc.
- 21.4 The Contractor shall allow for all expendable materials necessary for servicing such as lubricating oils, grease, refrigerant and cleaning materials.
- 21.5 Replacement filters, if required, will be provided by and at the expense of the Client.

22. MAINTENANCE INSTRUCTION OF OWNER'S STAFF

- 22.1 Bidders shall make proper allowance in their bid price for instruction of the Client's / Owner's staff in the maintenance, repair and adjustment of all the equipment. Allowance must be made for the proper hands-on tuition of the owner's personnel at the appropriate time to enable them to take over operational duties.

23. SPARE PARTS AND AGENCIES

- 23.1 Where Bidders offer plant embodying units of manufacture other than those of their principals and for which they are not accredited South African agents, and for which they do

	New Libraries for the Limpopo Department of Sports, Art and Culture (DSAC) Library Name: LDPWRI-PROF/18005	Rev	00
		SQET File	
		ECSA Stage	4
		Discipline	Mechanical

not stock spare parts, they should state in the bid the name of the accredited South African agents from whom spare parts for such units are obtainable.

- 23.2 In all cases, Bidders should furnish an undertaking from agents to the effect that they are prepared to carry the necessary stock of spare parts for their particular units.
- 23.3 Bidders are also required to furnish the same undertakings as regards the spares for units manufactured by their own principals.
- 23.4 During adjudication of bids, consideration may be given not only to the cost of the plant offered, by also to the cost of the spares.

24. TOOLS

- 24.1 All special tools required, i.e., tools specially designed for the particular equipment offered, must be supplied and listed in the bid offer and included in the unit price. In the case of a number of identical items of plant being supplied it will only be necessary to supply two sets of tools covering all units, and not one set for each unit.
- 24.2 It is the responsibility of the Contractor to ensure that all tools are handed over to the Engineer on completion of the contract, in brand new condition. No damaged tools will be accepted, and the contract will not be considered complete until such tools are satisfactorily received. Tools handed over shall be suitably mounted on a wallboard or supplied in a high- quality metal box or other container as may be agreed to by the Engineer.

25. OPERATING, MAINTENANCE INSTRUCTIONS, WIRING AND CONTROL DIAGRAMS

- 25.1 The Contractor shall prepare and supply comprehensive manuals for the successful operation and maintenance of the installation. A draft of the manual shall be submitted to the Engineer after commissioning, for approval. The draft shall then be corrected, if required, and THREE sets of the manual shall be submitted before first acceptance of the plant will be considered.
- 25.2 Manuals shall be prepared in the same language as the contract documents unless otherwise required by the Engineer. These manuals shall be bound in hard file covers with clear titles and indices and shall contain the following information as a minimum, in the sections indicated:

	New Libraries for the Limpopo Department of Sports, Art and Culture (DSAC) Library Name: LDPWRI-PROF/18005	Rev	00
		SQET File	
		ECSA Stage	4
		Discipline	Mechanical

SECTION 1: System Description

Refer to PART 6 : Drawings

SECTION 2: Commissioning Data

The results of all checks and measurements as recorded during the commissioning period, shall be compiled in such a manner that every check and measurement is clearly defined.

SECTION 3: Operating Instructions

- i. Plant running check list and frequency of servicing.
- ii. Safety precautions to be taken.
- iii. Manual and automatic operation.
- iv. Operator's duties.
- v. Lubricating oils and service instructions.
- vi. Pre-start checklist for each system.
- vii. Starting and stopping procedures.

SECTION 4: Mechanical Equipment

- i. Description of all major items of equipment with the make, model number, names, addresses and telephone numbers of the Supplier, Manufacturer or their Agents.
- ii. Design capacities of all equipment including selection parameters, selection curves, capacity tables, etc.
- iii. Manufacturer's brochures and pamphlets.
- iv. Schedule of spares with part numbers recommended to be held in stock by the Engineer.

SECTION 5: Maintenance Instructions

- i. Schedule of maintenance particulars, frequency of service and replacements.
- ii. Troubleshooting guide.
- iii. Part number of all replacement items and spares.
- iv. Capacity curves of pumps, fans and compressors.
- v. Serial number of main items of equipment.

	New Libraries for the Limpopo Department of Sports, Art and Culture (DSAC) Library Name: LDPWRI-PROF/18005	Rev	00
		SQET File	
		ECSA Stage	4
		Discipline	Mechanical

SECTION 6: Electrical Equipment

- i. Schedule of equipment indicating manufacturer, type, model number, capacity and address and telephone number of suppliers.
- ii. Maintenance instructions.
- iii. Manufacturer's brochures and pamphlets.
- iv. Complete "as-built" circuit diagrams and diagrammatic representation of inter-connections of electrical equipment.

SECTION 7: Instrumentation and Control

- i. Description of each control system.
- ii. Schedule of control equipment indicating make, type, model number, rating, capacity and name, address and telephone number of suppliers.
- iii. Maintenance instructions.
- iv. Manufacturer's brochures and pamphlets.

SECTION 8: Drawings

- i. Paper prints (reduced if so desired) of all "as-built" mechanical and electrical Contractor's drawings.
- ii. Wiring diagrams, framed behind glass shall be mounted adjacent to each relevant control panel.

26. EQUIPMENT TO BE USED WHEN ERECTING INSTALLATION

- 26.1 Bids shall allow for a complete installation, including the provision of mobile cranes, air compressors, lifting tackle, measuring equipment, precision levels, and all other special or regular tools and equipment that may be needed to complete the entire installation in accordance with the specification, and to the satisfaction of the Engineer.
- 26.2 The Contractor will be responsible for any damage caused to buildings, equipment, etc. during the course of the erection of his/her equipment.

27. ASSEMBLY OF COMPONENTS

- 27.1 It is essential that all mating components such as couplings, taper lock bushes, machine faces, etc., be thoroughly cleaned with a suitable solvent before assembly. All surfaces must be free from burrs or irregularities, which may prevent the correct mating of the surfaces.

	New Libraries for the Limpopo Department of Sports, Art and Culture (DSAC) Library Name: LDPWRI-PROF/18005	Rev	00
		SQET File	
		ECSA Stage	4
		Discipline	Mechanical

27.2 A molybdenum -disulphide lubricant similar or equivalent to Mobil- grease Super shall be used on the threads of all bolts and between the mating surfaces of all parts closely fitted together, such as shafts and couplings, keys and base plates. PTFE tape shall be used in all screwed pipe connections.

28. WELDING

28.1 Welding shall be carried out in accordance with the current edition of SABS 044 Parts I to VII where applicable.

28.2 All welder filler or butt joints shall be free from porosity, cavities and entrapped slag. Joints shall be ground smooth, if required for aesthetic reasons only, without affecting weld strength.

28.3 The joints in the weld run, where welding has been recommended, shall be as smooth as possible and shall show no pronounced hump or crater in the weld surface.

28.4 The profile of the weld shall be uniform, of approximately equal leg length and free from overlap at the toe of the weld. Unless otherwise specified the surface shall be either flat or slightly convex in the case of fillet welds and with reinforcement of not more than 3mm in the case of butt welds.

28.5 The weld face shall be uniform in appearance throughout its length.

28.6 Filler metal electrodes shall be of an approved type for the material being used and shall be kept in a dry condition. All electrodes shall conform to SABS 455.

28.7 Only welders in possession of a valid approved competence certificate shall be employed.

28.8 All welds must show proper fusion.

28.9 Where welding is contemplated in pipework systems, Bidders shall allow for the removal and testing by an approved body of 5% of the welded joints in the system. These will be removed at random as indicated by the Department and tested. Should faulty welding be discovered, all other joints shall be X-ray tested by the SABS or an approved body, all at the expense of the Contractor.

29. GALVANIZING

29.1 Unless otherwise specified in the Supplementary Specification the following items shall always be galvanized:

	New Libraries for the Limpopo Department of Sports, Art and Culture (DSAC)		Rev	00
	Library Name:		SQET File	
	LDPWRI-PROF/18005		ECSA Stage	4
			Discipline	Mechanical

- 29.2 Fabricated mild steel sections exposed to the weather.
- 29.3 Steel grilles and louvres exposed to the weather.
- 29.4 Where hot dip galvanizing is called for, items to be galvanized shall be entirely pre-fabricated and then dismantled in sections for galvanizing. No cutting of threads or welding will be accepted after galvanizing.
- 29.5 All hot dip galvanizing shall be carried out in accordance with SABS 934 and SABS 763 where applicable, including preparation for galvanizing.
- 29.6 Mild steel plate and sections shall be of good commercial quality, best suited for galvanizing. The materials shall be free from slag or coarse laminations, fine fissures and rolled-in impurities.
- 29.7 Castings shall be sound, dense and clean, and free from distortion, porosity, carbon and slag enclosures, blowholes and other injurious conditions.
- 29.8 Welding flux shall be chipped away and all welds wire brushed before galvanizing.
- 29.9 The surface to be galvanized shall be free from paint, oil, grease and similar impurities.
- 29.10 All exposed surfaces including welds shall be thoroughly sand blasted prior to galvanizing.
- 29.11 The Engineer reserves the right to inspect all steel components before galvanizing and shall have the right to reject or ask for remedial treatment of any material which is considered to be unsuitable. This applies particularly to welds.
- 29.12 The galvanizing coating shall be smooth, adherent, continuous and free from black spots or flux stains.
- 29.13 Globular extra-heavy deposits of zinc which interfere with the intended use of the material will not be acceptable. Excessively protuberant lumps and nodules shall be removed by hot wiping or by the skilful application of mechanical means, however there shall remain a sufficient minimum thickness of unbroken zinc coating. Flaws on small parts and working surfaces shall be repaired only by stripping and re-dipping.
- 29.14 Repairs to galvanized coatings will not be accepted. Items damaged will need to be re-galvanized.
- 29.15 Coating thickness shall be as per table 1 of SABS 763 unless otherwise specified in the supplementary specification.
- 29.16 The SABS requirement for uniformity shall apply.
- 29.17 Galvanized surfaces specified with paint finishing shall not be passivized.

	New Libraries for the Limpopo Department of Sports, Art and Culture (DSAC) Library Name: LDPWRI-PROF/18005	Rev	00
		SQET File	
		ECSA Stage	4
		Discipline	Mechanical

30. PAINTING

- 30.1 The entire installation, other than aluminium or stainless-steel pipe cladding, shall be painted, unless otherwise specified in the Supplementary Specification.
- 30.2 Painted items shall include plant room floors, equipment plinths and bases.
- 30.3 Before any painting is applied, the surfaces shall be prepared according to SABS 064, Code for Preparation of Steel Surfaces for Painting. All surfaces shall be moisture free, clean and properly prepared.
- 30.4 During painting, the Contractor shall ensure that all the necessary fire prevention and firefighting precautions have been taken.
- 30.5 Name plates, labels and notices on equipment shall not be painted.
- 30.6 Items which do not require painting such as diffusers and grilles, shall only be installed after the paint work on the plant, ceiling or walls have been completed.
- 30.7 Painted surfaces on proprietary manufactured items shall be adequately protected. Equipment on which the paint work has been damaged during installation shall be repainted before first delivery of the plant will be considered.
- 30.8 Unless otherwise specified in the Supplementary Specification the installation shall be painted in accordance with SABS colour coding where applicable. Colour code bands and arrow indicators shall be as per SABS 0140 of 1978, and the basic colour shall cover the full length and circumference of pipes and ducts.
- 30.9 Plastered surface inside plenums shall be painted with a suitable alkali resistant primer to SABS 1414-1987 followed by a universal undercoat with a final coat of high gloss enamel paint to SABS 630, Grade I. The colour of the final coat shall be white.
- 30.10 Lagged and plastered ductwork and plastered surfaces outside plenums shall be painted with a suitable alkali resistant primer to SABS 1414 of 1987 followed by one undercoat to SABS 681, type II and one coat high gloss enamel paint to SABS 630, Grade I or PVA exterior type emulsion paint to SABS 634 of 1974 as top coat.
- 30.11 Ferrous casings of cooling towers, evaporative condensers and sprayed coils including galvanized iron castings, sumps, fans and ductwork connected to outlets of cooling towers or evaporative condensers, shall be internally painted with two coats of epoxy-tar paint to SABS 801, type II.
- 30.12 Angle iron framework shall be similarly painted with epoxy paint before side covers are fitted. All steel surfaces shall be cleaned and painted with a wash primer or zinc chromate primer (un-galvanized iron) before the

	New Libraries for the Limpopo Department of Sports, Art and Culture (DSAC) Library Name: LDPWRI-PROF/18005	Rev	00
		SQET File	
		ECSA Stage	4
		Discipline	Mechanical

- 30.13 Exposed and unlagged galvanized piping shall be painted with one coat wash primer (self-etch primer) to SABS 723 followed by one undercoat to SABS 681, type II and one coat gloss enamel paint to SABS 630, Grade 1 as top coat.
- 30.14 Unlagged black piping, flat iron, angle iron, rods, etc., for supports, brackets, frames duct stiffeners, etc., shall be painted on all sides with a zinc chromate primer to SABS 679 type I, followed by one coat universal undercoat and one finishing coat of enamel paint to SABS 630 Grade 1.
- 30.15 Where specified in the supplementary specification, aluminium shall be painted with a wash primer to SABS 723 followed by a zinc chromate primer to SABS 679, type I and one coat universal undercoat to SABS 681-1972 type II and one final coat of enamel paint to SABS 630, Grade 1.
- 30.16 Where specified in the supplementary specification, steel surfaces shall be cleaned and then treated with the hot phosphate process to a minimum weight of 1.6 g/m² coating followed by two coats of backing enamel to SABS 783 type I.
- 30.17 All galvanized surfaces requiring painting other than those covered in 3.13.17 below shall be thoroughly degreased. In case a detergent is used, the surface shall be well rinsed and dried. It shall then be painted with one coat wash primer (self-etch primer) to SABS 723. When dry, the surface shall be painted with one undercoat to SABS 681 type II and one coat universal undercoat and one coat high gloss enamel paint to SABS 630, Grade 1 as top coat.
- 30.18 All galvanized surfaces inside air handling plenums and external within 50km of the coast, or as specified in the supplementary specification, shall be cleaned with a galvanized iron cleaner until a water break free surface is achieved. After drying one primer coat of “Galvo-Grip” or approved paint shall be applied followed by one coat of universal undercoat paint. A final coat of gloss enamel to SABS 630, Grade I shall then be applied.
- 30.19 For air handling units the entire air-conditioning unit casings, including galvanized iron eliminators, sumps, drip pans, fans, etc., shall be painted internally with two coats of epoxy-tar paint to SABS 801, type II. The white rust preventative compound on galvanized iron shall be removed as specified above before the paint is applied. Angle iron framework shall be similarly painted with epoxy paint before side covers are fitted.
- 30.20 Exposed piping with canvas covered insulation shall be painted two coats of bitumen aluminium paint to SABS 802 followed by the colour coding basic colour as per table 1.

31. ERECTION OF EQUIPMENT

- 31.1 General - Unless otherwise specified in the Supplementary Specification the design, manufacture and installation of all the mechanical and electrical equipment shall be such as to ensure compliance with the relevant sections of SABS 0103 of 1983 “The Measurement and

	New Libraries for the Limpopo Department of Sports, Art and Culture (DSAC)	Rev	00
	Library Name:	SQET File	
	LDPWRI-PROF/18005	ECSA Stage	4
		Discipline	Mechanical

Rating of Environmental Noise with Respect to Annoyance and Speech Communications”, as amended. Any installation where the measures residual sound level exceeds the maximum desired residual sound level as per SABS 0103 shall be rectified to comply with SABS 0103 at the Contractor’s own expense. In all plant room applications where, airborne noise cannot be limited or comply with the set standards, provision shall be made for acoustical treatment of the equipment involved or, alternatively, total enclosure thereof with acoustical panelling to comply with requirements laid down in this specification. Such provisions shall be included in the bid price and no claims for payment to comply with this requirement will be entertained.

- 31.2 Tenderers shall allow for a complete installation, including the provision of mobile cranes, air compressors, lifting tackle, measuring equipment, precision levels, and all other special or regular tools and equipment that may be needed to complete the entire installation in accordance with the specification, and to the satisfaction, of the Department.

The Contractor will be responsible for any damage caused to buildings, equipment, etc. during the course of the erection of his equipment.

a. **Equipment Plinths** - Plinths as specified hereunder shall not be confused with any form of inertia or anti-vibration base. Unless otherwise specified in the Supplementary Specification, equipment plinths shall form part of the air conditioning and ventilation contract. Plinths shall be provided for all mechanical and electrical equipment. Plinths cast on concrete surfaces shall protrude at least 200mm above floor levels and depending on the position of the vibration mountings, shall be at least 200mm wider or longer than the inertia bases mounted on top. Plinths for equipment which do not need inertia bases or plinths for inertia bases with recessed vibration mountings shall be of the same size as the equipment or bases mounted on top. Plinths shall consist of 1,6mm thick channel or angle iron formers with 10mm thick reinforcing bars located at 150mm pitch in each direction and filled with concrete. The top surface of the concrete shall be floated to an even and smooth finish to allow for not less than 25mm and not more than 50mm of suitable cement or epoxy grout under the equipment base frame. A 25mm 45° chamfer shall finish off all grout corners. Plinths as specified above shall also be provided for field assembled plenum chambers and other equipment.

b. **Clamping Down Bolts and Bolts for Equipment** - The Contractor shall be responsible for the supply of all necessary holding down bolts for the machines supplied by him. He shall also supply all bolts necessary for assembling all the equipment supplied by him. Holding down bolts shall preferably be cast into concrete bases when the bases are being cast. All bolts shall, in this instance, be provided with galvanised sheet metal sleeves approximately three times the diameter of the bolt, and projecting a minimum of four-bolt diameters below the surface of the concrete. This sleeve must be kept free of concrete until the final grouting takes place. Under exceptional circumstances, the provision of suitably sized pockets for the holding down bolts will be permitted. Where galvanised bolts are called for, they shall be fully galvanised all over. No re-cutting of threads will be permitted after galvanising. All nuts must run freely on the threads.

	New Libraries for the Limpopo Department of Sports, Art and Culture (DSAC) Library Name: LDPWRI-PROF/18005	Rev	00
		SQET File	
		ECSA Stage	4
		Discipline	Mechanical

- c. **Vibration Isolation** - Proper provisions shall be made in the foundations and mountings of all equipment capable of transmitting vibration forces to its environment, whether local or remote for vibration isolation.
- d. **Damping** - Where static deflections in excess of 8mm are indicated, steel springs shall be employed incorporating acoustic sound pads in series with the spring. The horizontal stiffness of the springs shall not exceed that in the vertical, in particular for systems mounted at vertical frequencies below 5Hz. Low frequency mounts shall incorporate rubber snubbers to accommodate extreme horizontal or vertical motions such as can occur near resonance during start up. The snubbers shall however not be relied upon to provide the necessary horizontal stability of the machine in normal operational conditions. Spring layouts and inertia blocks shall be employed to avoid this situation. For static deflections below 8mm, rubber in shear mounts may be used provided the frequency is above 6Hz.
- For small static deflections less than 4mm and particularly for high-speed machines and general acoustic isolation, ribbed rubber neoprene composite pads may be employed subject to the specified requirements. No equipment shall be installed in critical areas without correct and approved vibration isolation. Sufficient stability and damping shall be incorporated in the mountings to minimise the movement of the machine during start up or changes in the operating conditions. The selection of mounts shall take proper cognisance of unequal distribution of the mounting weight of equipment and rotational and/or pressure forces acting thereon.

32. ELECTRICAL EQUIPMENT AND INSTALLATION

- 32.1 Unless otherwise stated in the Supplementary Specification Bidders must allow in their price for the complete electrical installation and wiring in accordance with SABS code of Practice for the Wiring of Premises 0142 of 1981 as amended.
- 32.2 All electrical equipment and wiring shall be in accordance with the current issue of the Standard Specification for Electrical Equipment and Installation for Mechanical Services. Copies can be obtained from the Department, Private Bag X65, PRETORIA, 0001.
- 32.3 Power terminal points will be as specified in the Supplementary Specification.
- 32.4 Ammeters and pilot lights shall be provided for electric heaters, one of each for each step of heating.

	New Libraries for the Limpopo Department of Sports, Art and Culture (DSAC) Library Name: LDPWRI-PROF/18005	Rev	00
		SQET File	
		ECSA Stage	4
		Discipline	Mechanical

- 32.5 All compressor motors over 5kW shall be provided with an approved electronic type motor protection unit in addition to the protection called for in the Standard Specification for Electrical Equipment and Installation for Mechanical Services.
- 32.6 Clause 1.2.1 (a) of the Standard Electrical Specification shall read “The South African Bureau of Standards Code of Practice for the Wiring of Premises as amended”.
- 32.7 In conventional field assembled plants lighting wired from the air conditioning control panel shall be provided for the filter chamber, coil chamber and fan chamber and shall comprise of bulkhead fittings permanently fixed to the walls or ceiling and earthed directly to the main earthing bar of the switchboard by means of a 4mm² bare copper earth continuity conductor, in addition to being earthed by means of the continuity of the conduit as specified in the Standard Electrical Specification.
- 32.8 The fault level of the air conditioning distribution board shall be as specified in the Supplementary Specification.
- 32.9 In the case of small wiring direct from busbars, e.g., voltmeter supply, suitable protection fuses shall be mounted directly onto the busbars.
- 32.10 The possibility of inadvertent contact with live terminals shall be avoided at all cost. All apparatus and wiring behind readily accessible hinged doors or panels shall be protected against finger contact by means of insulating panels (Perspex or similar approved material) or other approved method. Busbar mounted voltmeter fuses shall be mounted on insulated back plates to afford complete safety from hand contact with busbars or other conductors in the immediate vicinity.

33. SELECTION OF EQUIPMENT

- 33.1 All equipment shall be selected with due regard to the installation site conditions, particularly with respect to:
- Altitude
 - Ambient temperatures
 - Atmospheric conditions
- 33.2 Equipment shall at all times be selected to operate within the limits recommended by the particular manufacturer.
- 33.3 Where equipment will be required to operate at conditions deviating from the manufacturer’s standard selection tables, re-rating shall be done strictly in accordance with the manufacturer’s methods.



LIMPOPO

PROVINCIAL GOVERNMENT
REPUBLIC OF SOUTH AFRICA

DEPARTMENT OF
PUBLIC WORKS, ROADS & INFRASTRUCTURE

PROJECT NAME NEW LIBRARIES FOR THE LIMPOPO DEPARTMENT OF SPORTS, ART AND CULTURE (DSAC) AT THE FOLLOWING LOCATIONS: BOTSHABELO (WATERBERG DISTRICT), TSHAULU (VHEMBE DISTRICT), SEKHUKHUNE DISTRICT AND VLEIFONTEIN (VHEMBE DISTRICT)

LIBRARY NAME ALL SITES

PROJECT NO. LDPWRI-PROF/18005

DOCUMENT TITLE SPECIFICATIONS FOR MECHANICAL INSTALLATIONS

PART NUMBER 3 – TECHNICAL SPECIFICATIONS
3.3 WET SERVICES

REVISION 00

EMPLOYER	CONSULTING ENGINEERS
LIMPOPO DEPARTMENT OF PUBLIC WORKS AND INFRASTRUCTURE 43 CHURCH STREET POLOKWANE 0700	SUPERIOR QUALITY ENGINEERING AND TECHNOLOGIES 60 MAGAZYN STREET POLOKWANE 0699

SEPTEMBER 2021

	New Libraries for the Limpopo Department of Sports, Art and Culture (DSAC) Library Name: LDPWRI-PROF/18005	Rev	00
		SQET File	
		ECSA Stage	4
		Discipline	Mechanical

DOCUMENT CONTROL

Project Name	New Libraries for the Limpopo Department of Sports, Art and Culture (DSAC) at the following locations: Botshabelo (Waterberg District), Tshaulu (Vhembe District), Sekhukhune district and Vleifontein (Vhembe District)
Project Number	LDPWRI-PROF/18005
Library Name	-
Client Name	New Limpopo Department of Public Works and Infrastructure

ECSA Project Stage	Stage 4: Specifications
Document Type	Specifications For Mechanical Installations
Part Number	3 – Technical Specifications 3.3 Wet Services
Installations	Mechanical
SQET File Number	

	COMPILED	REVIEWED	SIGNED	APPROVED
NAME	T. C Mango	T. Magada	B. Nyambiya	
ORGANISATION	SQET	SQET	SQET	
DESIGNATION	Lead Engineer	Project Engineer	Principal Engineer	
DATE	06 September 2021	07 September 2021	09 September 2021	

	New Libraries for the Limpopo Department of Sports, Art and Culture (DSAC) Library Name: LDPWRI-PROF/18005	Rev	00
		SQET File	
		ECSA Stage	4
		Discipline	Mechanical

TECHNICAL SPECIFICATION

CONTENTS

DOCUMENT CONTROL	1
1 GENERAL ADMINISTRATIVE REQUIREMENTS	3
1.1 GENERAL	3
1.2 CONFIDENTIALITY	3
1.3 DEVIATIONS FROM STANDARD SPECIFICATION.....	3
1.4 COMPLIANCE WITH REGULATIONS	3
1.5 MUNICIPAL CONNECTIONS.....	4
1.6 MUNICIPAL COSTS	4
1.7 MAKE OF EQUIPMENT	4
1.8 MATERIALS, WORKMANSHIP AND ALTERNATIVE MANUFACTURE.....	4
1.9 DRAWINGS, BUILDER’S WORK AND CO-ORDINATION WITH OTHER TRADES.....	5
1.10 CONFIRMATION OF ISSUES	6
1.11 OTHER ENGINEERING CONTRACTS.....	6
1.12 NOISE.....	6
1.13 PROTECTION.....	6
1.14 TESTING AND INSPECTIONS.....	7
1.15 TUITION	7
1.16 GUARANTEE AND MAINTENANCE	7
2 HVAC.....	9
2.1 PIPING	9
2.2 SPECIFICATIONS FOR AIR-HANDLING UNIT	9
2.3 SPECIFICATIONS FOR VRV SYSTEM	10
2.4 SPECIFICATIONS FOR SPLIT SYSTEM.....	10
2.5 SPECIFICATIONS FOR EXTRACTION FANS.....	11
2.6 SPECIFICATIONS FOR SUPPLY FAN.....	11
2.7 SPECIFICATIONS FOR RETURN AIR GRILLE	11
2.8 SPECIFICATIONS FOR SIDE WALL AIR GRILLES	12
2.9 SPECIFICATIONS FOR CEILING GRILLES.....	12
2.10 SPECIFICATIONS FOR DOOR GRILLES	12
2.11 SPECIFICATIONS FOR DIFFUSERS.....	12
2.12 SPECIFICATIONS FOR DIFFUSERS.....	13
2.13 SPECIFICATIONS FOR EXTRACTION VANES.....	13
2.14 SPECIFICATIONS FOR BALANCING DAMPERS.....	13
2.15 SPECIFICATIONS FOR AHU FILTER BANKS.....	13
2.16 SPECIFICATIONS FOR FAN FILTER BANKS.....	14
2.17 SPECIFICATIONS FOR FAN DUCT ATTENUATORS.....	14
2.18 SPECIFICATIONS FOR DUCTING	14

	New Libraries for the Limpopo Department of Sports, Art and Culture (DSAC) Library Name: LDPWRI-PROF/18005	Rev	00
		SQET File	
		ECSA Stage	4
		Discipline	Mechanical

GENERAL SPECIFICATIONS

1 GENERAL ADMINISTRATIVE REQUIREMENTS

1.1 GENERAL

This Standard Specification shall be read in conjunction with the Bills of Quantities, if any, the Project Specification and Drawings, in which the exact extent of the work will be identified.

1.2 CONFIDENTIALITY

All drawings, memoranda, ideas and information supplied for the works shall remain the property of the party so supplying such drawings, memoranda, ideas and information on the express understanding that they will be treated as private and confidential and not be used in any way, except in connection with the single installation for which they are intended

No details of any drawings, memoranda, ideas and information shall be published or disclosed in any trade or technical paper or elsewhere without the previous consent in writing of the party that supplied such drawings, memoranda, ideas and information.

1.3 DEVIATIONS FROM STANDARD SPECIFICATION

The quality of workmanship, materials to be used, equipment etc., shall be as specified in these documents. Where discrepancies exist between the Bills of Quantities, the Standard Specification and the Detailed Specification, the Detailed Specification shall have preference over both the Bills of Quantities and Standard Specification. The Standard Specification shall furthermore have preference over the Bills of Quantities.

Any discrepancies found between the Bills of Quantities, Standard and Detailed Specifications shall be brought to the attention of the Quantity Surveyor and Engineer in writing within seven (7) days of its discovery.

1.4 COMPLIANCE WITH REGULATIONS

The works shall comply with all the requirements and bylaws of the relevant local authorities. Where the proposed layouts, or any of the materials specified, etc., do not comply with the regulations, the matter shall immediately be brought to the attention of the Engineer in writing.

The complete works shall comply in particular with the specifications and requirements of:

1. All South African National Standards associated with the construction and safety of wet services installations and associated equipment.
2. The Occupational Health and Safety Act, Act 85 of 1993, as amended.
3. The appropriate South African National Standards governing building regulations.
4. The South African National Standards applicable to the wiring of premises.
5. This detailed specification and the drawings forming part of the tender documents.

Certificates of approval from the local authority, if called for, shall be delivered to the Engineer and/or Quantity Surveyor before the final payment certificate shall be issued.

	New Libraries for the Limpopo Department of Sports, Art and Culture (DSAC) Library Name: LDPWRI-PROF/18005	Rev	00
		SQET File	
		ECSA Stage	4
		Discipline	Mechanical

1.5 MUNICIPAL CONNECTIONS

The Sub-contractor shall make application, with the relevant local authority for the municipal mains connection, complete with all meter(s), necessary valves, valve chamber, etc. as directed by the local authority.

The connection(s) details are described in the Detailed Specification and/or drawings.

1.6 MUNICIPAL COSTS

The cost of the municipal connection, inspection fees, or any other charges levied by the local authority shall be borne by the Sub-contractor.

Where a Provisional Sum has been allowed for these costs, the plumbing Sub-contractor shall obtain a firm price from the local authority on award of the subcontract, and advise the Engineer and Quantity Surveyor of these costs in writing.

1.7 MAKE OF EQUIPMENT

Similar items of equipment used throughout this contract shall be of the same make and, where applicable, of the same model.

1.8 MATERIALS, WORKMANSHIP AND ALTERNATIVE MANUFACTURE

Materials, workmanship and equipment offered shall be as specified herein. Should the tenderer wish to offer alternative materials, equipment, etc., the details shall be submitted at close of tender in a covering letter accompanying the tender and clearly identifying the extent, quality and advantages of the alternative(s).

All materials shall be of the qualities specified and the Sub-contractor shall, upon request by the engineer, furnish the engineer with proof to his reasonable satisfaction that the materials are of the specified quality

The Sub-contractor shall keep the contractor and the engineer informed regarding the placing of all orders for materials and the progress of manufacture or any article or materials

All materials shall be new unless otherwise instructed or specified.

Materials, goods and equipment described by trade names or catalogue references shall be of the type and manufacture specified. Alternative materials, goods and equipment equal to those specified may be offered. The decision whether the alternative articles are acceptable shall rest with the engineer

Where alternatives for such materials, goods and equipment are permitted, the Sub-contractor shall be liable for latent defects in such materials, goods and equipment and or the cost of making good physical loss and repairing damage to the works resulting therefrom.

Once accepted, the same type and make of material, goods and/or equipment shall be used and installed throughout the project for a specific application.

	New Libraries for the Limpopo Department of Sports, Art and Culture (DSAC) Library Name: LDPWRI-PROF/18005	Rev	00
		SQET File	
		ECSA Stage	4
		Discipline	Mechanical

1.9 DRAWINGS, BUILDER'S WORK AND CO-ORDINATION WITH OTHER TRADES

The principal agent and/or architect is responsible for the primary coordination of the design elements and the Sub-contractor shall cooperate in the detailed coordination while preparing his shop drawings.

The drawings applicable to the works where relevant shall consist of:

1. The wet services engineer's drawings.
2. The architect's drawings.
3. The structural engineer's drawings.
4. Consultant's drawings of other disciplines.
5. The drawings of other service installations that are relevant for co-ordination and installation purposes.
6. The installation drawings of other Sub-contractors, where applicable.

Electronic copies of the engineer's drawings, specifications and schedules and relevant drawings of other agents shall be issued to the Sub-contractor for information and for installation purposes.

The physical sizes of the equipment offered shall be suitable for the locations shown on the drawings and shall be positioned in such a manner to ensure reasonable access all around the equipment for maintenance purposes and as may be recommended by the suppliers of the equipment.

The Sub-contractor shall, at tender stage, check and ensure that enough space has been allocated for the erection of his equipment and services, taking note of other services sharing the same space. Should the spaces indicated on the Engineer's drawings not be adequate, the tenderers shall at the time of tender advise the Engineer accordingly and, where relevant, submit with their tenders a sketch indicating the required space.

The Sub-contractor shall plan his work in advance and shall coordinate all space requirements in conjunction with the Principal Contractor, especially where other trades share the same space. Where conflicts occur, the Sub-contractor shall request clarification from the Architect and/or Engineer.

Provision will be made in the design of the building structure to accommodate the specified installation. The Sub-contractor shall supply to the engineer two copies of Builder's work drawing, or marked-up structural or other drawings detailing any changes and additional requirements such as holes, machine bases, chases, recesses, service ducts, wooden sleeves and frames, etc., as herein identified being provided by others and which will be required to accommodate his services, plant and materials. This information is to be supplied timeously to the engineer in accordance with the design and construction programme.

No structural element shall be erected and no holes shall be cut or made through the structure and no items of equipment shall be supported from the structure without the prior approval of the Structural Engineer or at least the Principal Contractor. Where foundations, machine bases, drained ducts, floor channels, cable sleeves, etc., have been identified herein to be provided by others, the Sub-contractor shall liaise and assist the Principal Contractor or others in setting out, locating, etc., of these items.

The Sub-contractor shall be responsible for the cost of all cutting, patching, making good, etc., as may be required to accommodate his work due to late or wrong information been given by the Sub-contractor.

Formal shop drawings need not be prepared by the Sub-contractor, but copies of the engineer's drawings shall be marked up by the Sub-contractor and submitted via the contractor to the engineer for approval. These approved marked-up drawings shall be considered to be the working drawings. The engineer's approval of drawings or samples is limited to checking for conformity with design requirements. This shall not relieve the Sub-contractor of responsibility for erecting, installing, fitting or for deviating from the requirements of the

	New Libraries for the Limpopo Department of Sports, Art and Culture (DSAC) Library Name: LDPWRI-PROF/18005	Rev	00
		SQET File	
		ECSA Stage	4
		Discipline	Mechanical

agreement unless the Sub-contractor has informed the engineer in writing of such deviation at the time of submission of drawings or samples, and the engineer has given written approval for the specific deviation. The engineer's approval shall not relieve the Sub-contractor of responsibility for errors or omissions in the drawings or samples.

Any work installed before approval of working drawings may be liable for removal at the engineer's discretion.

The engineer's drawings and specifications shall be considered binding with regard to the quality, quantity, general scheme system, arrangement and function of the works. All dimensions specially marked on the drawings shall be strictly followed.

1.10 CONFIRMATION OF ISSUES

Notwithstanding anything to the contrary as may be set down in the Subcontract Agreement, but rather as an extension to these clauses, it will be in the interest of the Sub-contractor to ensure that any verbal instruction, directive, explanation, etc., given as well as any agreement made or whatever, whether it will involve a variation or not, is confirmed in writing by the Engineer and/or the Principal Contractor within 14 days of it being given or made.

Failure on the side of the Sub-contractor to do so may invalidate any claim for a variation to the works and additional payment.

1.11 OTHER ENGINEERING CONTRACTS

Where water supplies and drainage are requested for air-conditioning plants, water softeners, boilers, calorifiers, hot water tanks, sterilisers and similar equipment provided outside the scope of the plumbing Sub-contractor's work, the extent of the plumbing Sub-contractor's responsibility will be as stated in the Project Specification.

The plumbing Sub-contractor shall, unless otherwise instructed in the Project Specification, terminate his piping with isolating valves in the positions indicated on the drawings.

1.12 NOISE

All water systems, including all mechanical equipment installed in said system, shall be free from objectionable noises, such as water hammer, etc. The Sub-contractor shall in the installation of all materials and equipment, and at commissioning, ensure the above.

Any equipment generating unacceptable noises, in the opinion of the Engineer, shall be corrected or dampened as directed by the Engineer at no additional cost to the subcontract.

1.13 PROTECTION

The Sub-contractor shall protect all work and material, i.e. his and others, from damage by his work and workmen, and shall be liable for all damage caused should the protection not be provided or prove to be inadequate. The Sub-contractor's responsibility in this respect shall extend until his work and equipment have been finally inspected, tested and accepted.

	New Libraries for the Limpopo Department of Sports, Art and Culture (DSAC) Library Name: LDPWRI-PROF/18005	Rev	00
		SQET File	
		ECSA Stage	4
		Discipline	Mechanical

Open ends of pipework shall be closed with temporary covers or plugs during storage and construction to prevent entry of obstructing material. This shall be strictly enforced.

1.14 TESTING AND INSPECTIONS

The plumbing Sub-contractor shall, at his own cost, make all necessary arrangements and provide all necessary facilities for testing and inspection of the installation by the local authorities concerned and other authorised interested parties. The plumbing Sub-contractor shall provide any instruments or equipment required for these tests. The execution of these tests shall be to the complete satisfaction of the inspecting authorities/parties.

1.15 TUITION

The sub-contractor shall provide capable instructor/s to train the client's personnel. The instructor/s shall be available for a total period of 1 (one) working day (eight hours) after the system has been commissioned and handed over to the client. The Operating and Maintenance Manuals shall be in possession of the client before the training commences.

Training provided must include:

1. Information provided in the Design Intent Report (including energy / environmental features)
2. Review of controls set up, programming, alarms and troubleshooting
3. Review of O&M manuals
4. Building operation (start up, normal operation, unoccupied operation, seasonal changeover, shutdown)
5. Measures that can be taken to optimise energy efficiency
6. Occupational Health and Safety (OH&S) issues
7. Maintenance requirements and sourcing replacements; and
8. Obtaining and addressing occupant satisfaction feedback

1.16 GUARANTEE AND MAINTENANCE

The Sub-contractor shall guarantee the works against defects for a period of one (1) year from date of completion.

The guarantee shall cover all defects to the works and shall provide for the replacement or repair of all components that become defective during the guarantee period. Consumable components are excluded from the guarantee.

Where component parts or equipment are supplied by the employer, the contractor or the agent or where the make is specified without an alternative, then the Sub-contractor shall be responsible for such component parts or equipment only to the extent that the Sub-contractor is able to assign to the employer the benefit of warranties by the supplier or manufacturer.

The works is to be operated and maintained in accordance with the Operating and Maintenance Manuals prepared by the Sub-contractor. Any damage to the works resulting from the employer's failure to comply with the procedures set out in these manuals will not be covered by the guarantee.

	New Libraries for the Limpopo Department of Sports, Art and Culture (DSAC) Library Name: LDPWRI-PROF/18005	Rev	00
		SQET File	
		ECSA Stage	4
		Discipline	Mechanical

The sub-contractor shall provide free maintenance for a period of 1 (one) year following the hand over to the client. The maintenance shall include for all management, labour, lubricating materials, cleaning materials and transport.

The guarantee shall be given to the Principle Contractor. Where the guarantee period extends beyond the patent defects liability period of the Principal Building Agreement, the guarantee shall be ceded to the employer for the remainder of the period.

	New Libraries for the Limpopo Department of Sports, Art and Culture (DSAC) Library Name: LDPWRI-PROF/18005	Rev	00
		SQET File	
		ECSA Stage	4
		Discipline	Mechanical

TECHNICAL SPECIFICATIONS

2 HVAC

2.1 PIPING

Air-conditioned rooms shall be maintained at 23 °C and a relative humidity of 50% during summer and winter conditions. High workmanship standards shall be attained with all finishes, colour selection and painting that shall blend with architectural requirements, as well as the rest of the specification (this document).

All refrigerant piping, power cables and drain pipes shall be covered by galvanised steel or PVC trunking that shall be painted to blend in with other background colours as required by architectural design and the rest of the specification (this document). Performance parameters of air-conditioning units shall be derated for specified conditions.

2.2 SPECIFICATIONS FOR AIR-HANDLING UNIT

Air Handling Unit			
Parameter(Unit)			
Unit	Model	—	FOUR53
	Product Code	—	
Nominal Capacity	Cooling	kW	53
		Btu/h	180000
	Heating	kW	56
		Btu/h	191000
EER/C.O.P.		Btu/W	
Sound Pressure Level (H/M/L)*		dB (A)	76.9
Air Flow Volume		CFM	7000
Rated ESP		Pa	90
Power supply		V-Hz-Ph	380-415-50-3
Power Input	Cooling		16.7
	Heating		17.2
MCA		A	
Refrigerant	Refrigerant Type	—	R410A
	Throttling Method	—	Throttle
	Charge	kg	61 +3.0
Evaporator Fan motor	Diameter	inch	
	Motor Drive Type	—	Belt
Compressor	Type	—	Fixed Scroll
	Quantity	—	2
Condenser Fan motor	Quantity	—	1
Drainage Connection Size		mm	25
Operating Range		Cooling	10-46
		Heating	-9-24

	New Libraries for the Limpopo Department of Sports, Art and Culture (DSAC) Library Name: LDPWRI-PROF/18005	Rev	00
		SQET File	
		ECSA Stage	4
		Discipline	Mechanical

2.3 SPECIFICATIONS FOR VRV SYSTEM

Item Description	Specification
Model Type	DVMs Eco Outdoor Unit
Make	SAMSUNG ®
Model Code	AM100KXMDGH/EU
Cooling/Heating Capacity	28.0 / 31.5 kW
Power Input	7.30kW
Power Supply	3Ph / 380-415 V / 50Hz
Refrigerant Type	R410

Item Description	Specification
Installation Type	DVMs Eco Indoor Unit (Ceiling Cassette)
Make	SAMSUNG ®
Model Code	AM056FN4DEH/EU
Cooling/Heating Capacity	5.60 / 6.30 kW
Power Input	32 Watts
Power Supply	1Ph / 220-240 / 50Hz
Refrigerant Type	R410

Item Description	Specification
Installation Type	DVMs Eco Indoor Unit (Wall Mounted)
Make	SAMSUNG ®
Model Code	AM056FN4DEH/EU
Cooling/Heating Capacity	5.60 / 6.30 kW
Power Input	48 Watts
Power Supply	1Ph / 220-240 / 50Hz
Refrigerant Type	R410

2.4 SPECIFICATIONS FOR SPLIT SYSTEM

Item Description	Specification
Model Type	CAC (Single Split Systems) – Outdoor Unit
Make	SAMSUNG ®
Model Code	AC052MXADKH/EU
Cooling	5.0 kW (Cooling Only)
Power Input	1.35kW
Power Supply	1Ph / 220-240V / 50Hz
Refrigerant Type	R410

Item Description	Specification
Installation Type	CAC (Single Split Systems) – Indoor Unit
Make	SAMSUNG ®
Model Code	AC052MNADKH/EU
Cooling	5.0 kW (Cooling Only)
Power Input	40 Watts
Power Supply	1Ph / 220-240V / 50Hz
Refrigerant Type	R410

	New Libraries for the Limpopo Department of Sports, Art and Culture (DSAC) Library Name: LDPWRI-PROF/18005	Rev	00
		SQET File	
		ECSA Stage	4
		Discipline	Mechanical

2.5 SPECIFICATIONS FOR EXTRACTION FANS

Item Description	Specification
Installation Type	Inline Extraction Fan
Make	System Air
Model Code	KVK Silent 315 EC
Flowrate	450L/s
Pressure	309 Pa
Power Input	360 Watts
Power Supply	1Ph / 220-240V / 50Hz

Item Description	Specification
Installation Type	Wall Mounted Extraction Fan
Make	System Air
Model Code	GX6 - 90800AW
Flowrate	75L/s
Pressure	150 Pa
Power Input	30 Watts
Power Supply	1Ph / 220-240V / 50Hz

2.6 SPECIFICATIONS FOR SUPPLY FAN

Item Description	Specification
Installation Type	Inline Supply Fan
Make	System Air
Model Code	KVK Silent 200 EC
Flowrate	200 L/s
Pressure	130 Pa
Power Input	120 Watts
Power Supply	1Ph / 220-240V / 50Hz

2.7 SPECIFICATIONS FOR RETURN AIR GRILLE

Item Description	Specification
Installation Type	Return Air Grille
Reference	SANS Approved
Flowrate	450 L/s
Dimensions	400 x 400 mm
Material	Aluminum
Colour	Refer to Architect

	New Libraries for the Limpopo Department of Sports, Art and Culture (DSAC) Library Name: LDPWRI-PROF/18005	Rev	00
		SQET File	
		ECSA Stage	4
		Discipline	Mechanical

2.8 SPECIFICATIONS FOR SIDE WALL AIR GRILLES

Item Description	Specification
Installation Type	Side Wall Air Grille
Reference	SANS Approved
Flowrate	450 L/s
Dimensions	300 x 300 mm
Material	Aluminum
Colour	Refer to Architect

Item Description	Specification
Installation Type	Side Wall Air Grille
Reference	SANS Approved
Flowrate	200 L/s
Dimensions	150 x 150 mm
Material	Aluminum
Colour	Refer to Architect

2.9 SPECIFICATIONS FOR CEILING GRILLES

Item Description	Specification
Installation Type	Ceiling Air Grille
Reference	SANS Approved
Flowrate	150 L/s
Dimensions	100 x 600 mm
Material	Aluminum
Colour	Refer to Architect

2.10 SPECIFICATIONS FOR DOOR GRILLES

Item Description	Specification
Installation Type	Door Air Grille
Reference	SANS Approved
Flowrate	150 L/s
Dimensions	400 x 300 mm
Material	Aluminum
Colour	Refer to Architect

2.11 SPECIFICATIONS FOR DIFFUSERS

Item Description	Specification
Installation Type	Ceiling Air Supply Diffuser (Large Cone)
Reference	SANS Approved
Flowrate	150 L/s
Dimensions	600 x 600 mm
Neck	300mm
Material	Aluminum

	New Libraries for the Limpopo Department of Sports, Art and Culture (DSAC) Library Name: LDPWRI-PROF/18005	Rev	00
		SQET File	
		ECSA Stage	4
		Discipline	Mechanical

Colour	Refer to Architect
--------	--------------------

2.12 SPECIFICATIONS FOR DIFFUSERS

Item Description	Specification
Installation Type	Ceiling Air Supply Diffuser (Large Cone)
Reference	SANS Approved
Flowrate	200 L/s
Dimensions	600 x 600 mm
Neck	250mm
Material	Aluminum
Colour	Refer to Architect

2.13 SPECIFICATIONS FOR EXTRACTION VANES

Item Description	Specification
Installation Type	Extraction Vane Diffuser (Small Cone)
Reference	SANS Approved
Flowrate	50 L/s
Dimensions	350 x 350 mm
Neck	150 mm
Material	Aluminum
Colour	Refer to Architect

2.14 SPECIFICATIONS FOR BALANCING DAMPERS

Item Description	Specification
Installation Type	Balancing Damper
Reference	SANS Approved
Flowrate	150 L/s
Diameter	300mm
Material	Galvanized See
Balancing Method	Manual

2.15 SPECIFICATIONS FOR AHU FILTER BANKS

Item Description	Specification
Installation Type	Air Filter Bank
Reference	SANS Approved
Flowrate	2100 L/s
Filter Media	Washable Filter Panel HEPA Washable Filter Panel
Panel Size	900 x 900 x 600mm

	New Libraries for the Limpopo Department of Sports, Art and Culture (DSAC) Library Name: LDPWRI-PROF/18005	Rev	00
		SQET File	
		ECSA Stage	4
		Discipline	Mechanical

2.16 SPECIFICATIONS FOR FAN FILTER BANKS

Item Description	Specification
Installation Type	Air Filter Bank
Reference	SANS Approved
Flowrate	2100 L/s
Filter Media	Washable Filter Panel HEPA Washable Filter Panel
Panel Size	200 x 200mm
Enclosure Dimensions	200 x 200 x 300(L) mm

2.17 SPECIFICATIONS FOR FAN DUCT ATTENUATORS

Item Description	Specification
Installation Type	Duct Silencers
Reference	BS 4718
Flowrate	2100 L/s

Sound attenuating units or treatment shall be provided as indicated and/or required to control the noise from air conditioning and ventilation systems to within the limits specified. Noise levels caused by the equipment shall not exceed the ambient noise levels by more than 7dB in each frequency on the site boundary. It should be noted that the provisions for sound attenuation shown the Engineer's drawings are based on average published data for equipment noise and inherent attenuation. To minimize the need for sound attenuation, fans shall be selected to operate near their maximum efficiency point when producing the required air quantity and static pressure. Sound attenuators and acoustic treatment in ducts shall be proof against fire, fungus and erosion and not produce dust or come loose. "Packaged" attenuators shall normally be flanged for bolted connections, and flexible duct connectors shall be used as shown or required. Attenuators shall have an air resistance not exceeding 50 Pa measured at maximum air quantity.

2.18 SPECIFICATIONS FOR DUCTING

Item Description	Specification
Installation Type	Insulated Ducting
Reference	SANS 1238:2005

Unless otherwise specified or noted, the following ductwork is to be insulated:

- Fresh air ductwork;
- Return air ductwork;

Unless otherwise specified or noted, insulation shall be applied to the outside of the duct. Ductwork insulation exposed to atmospheric conditions shall be covered by galvanized Sheetmetal panels soldered and lapped (Double Skin) so as to be weatherproof.

- DUCTING (INSIDE OF BUILDINGS): External insulation: 50mm fiberglass
- DUCTING (OUTSIDE OF BUILDINGS): 75mm fiberglass, Double Skin ducting.

Density: 16kg/m

Fixing: Mechanically fixed and pinned

	New Libraries for the Limpopo Department of Sports, Art and Culture (DSAC) Library Name: LDPWRI-PROF/18005	Rev	00
		SQET File	
		ECSA Stage	4
		Discipline	Mechanical

To ensure that the correct thickness of insulation and covering has been applied, the HVAC Contractor shall, if required to do so, cut one or more section from the finished insulation. If deficiencies are revealed, the Sub-Contractor.

	New Libraries for the Limpopo Department of Sports, Art and Culture (DSAC) Library Name: LDPWRI-PROF/18005	Rev	00
		SQET File	
		ECSA Stage	4
		Discipline	Mechanical



LIMPOPO

PROVINCIAL GOVERNMENT
REPUBLIC OF SOUTH AFRICA

DEPARTMENT OF PUBLIC WORKS, ROADS & INFRASTRUCTURE

PROJECT NAME	NEW LIBRARIES FOR THE LIMPOPO DEPARTMENT OF SPORTS, ART AND CULTURE (DSAC) AT THE FOLLOWING LOCATIONS: BOTSHABELO (WATERBERG DISTRICT), TSHAULU (VHEMBE DISTRICT), SEKHUKHUNE DISTRICT AND VLEIFONTEIN (VHEMBE DISTRICT)
LIBRARY NAME	ALL SITES
PROJECT NO.	LDPWRI-PROF/18005
DOCUMENT TITLE	SPECIFICATIONS FOR MECHANICAL INSTALLATIONS
PART NUMBER	3 – TECHNICAL SPECIFICATIONS 3.2 FIRE PROTECTION
REVISION	00

EMPLOYER	CONSULTING ENGINEERS
LIMPOPO DEPARTMENT OF PUBLIC WORKS AND INFRASTRUCTURE 43 CHURCH STREET POLOKWANE 0700	SUPERIOR QUALITY ENGINEERING AND TECHNOLOGIES 60 MAGAZYN STREET POLOKWANE 0699

SEPTEMBER 2021

	New Libraries for the Limpopo Department of Sports, Art and Culture (DSAC) Library Name: LDPWRI-PROF/18005	Rev	00
		SQET File	
		ECSA Stage	4
		Discipline	Mechanical

	New Libraries for the Limpopo Department of Sports, Art and Culture (DSAC) Library Name: LDPWRI-PROF/18005	Rev	00
		SQET File	
		ECSA Stage	4
		Discipline	Mechanical

DOCUMENT CONTROL

Project Name	New Libraries for the Limpopo Department of Sports, Art and Culture (DSAC) at the following locations: Botshabelo (Waterberg District), Tshaulu (Vhembe District), Sekhukhune district and Vleifontein (Vhembe District)
Project Number	LDPWRI-PROF/18005
Library Name	-
Client Name	New Limpopo Department of Public Works and Infrastructure

ECSA Project Stage	Stage 4: Specifications
Document Type	Specifications For Mechanical Installations
Part Number	3 – Technical Specifications 3.2 Fire Protection
Installations	Mechanical
SQET File Number	

	COMPILED	REVIEWED	SIGNED	APPROVED
NAME	T. C Mango	T. Magada	B. Nyambiya	
ORGANISATION	SQET	SQET	SQET	
DESIGNATION	Lead Engineer	Project Engineer	Principal Engineer	
DATE	06 September 2021	07 September 2021	09 September 2021	

	New Libraries for the Limpopo Department of Sports, Art and Culture (DSAC) Library Name: LDPWRI-PROF/18005	Rev	00
		SQET File	
		ECSA Stage	4
		Discipline	Mechanical

TECHNICAL SPECIFICATIONS

CONTENTS

DOCUMENT CONTROL	3
1 GENERAL ADMINISTRATIVE REQUIREMENTS	5
1.1 GENERAL	5
1.2 CONFIDENTIALITY	5
1.3 DEVIATIONS FROM STANDARD SPECIFICATION.....	5
1.4 COMPLIANCE WITH REGULATIONS	5
1.5 MUNICIPAL CONNECTIONS.....	6
1.6 MUNICIPAL COSTS	6
1.7 MAKE OF EQUIPMENT	6
1.8 MATERIALS, WORKMANSHIP AND ALTERNATIVE MANUFACTURE.....	6
1.9 DRAWINGS, BUILDER’S WORK AND CO-ORDINATION WITH OTHER TRADES.....	7
1.10 CONFIRMATION OF ISSUES	8
1.11 OTHER ENGINEERING CONTRACTS.....	8
1.12 NOISE.....	8
1.13 PROTECTION.....	8
1.14 TESTING AND INSPECTIONS.....	9
1.15 TUITION	9
1.16 GUARANTEE AND MAINTENANCE	9
2 FIRE PROTECTION.....	11
2.1 GENERAL	11
2.2 SCOPE OF CONTRACT	11
2.3 DRAWINGS	11
2.4 PAINTING AND FINISHING	13
2.5 CONTRACT MANAGEMENT OF MECHANICAL SUB-CONTRACTS	14
2.6 TESTING AND COMMISSIONING OF MECHANICAL INSTALLATIONS	16
2.7 MAINTENANCE OF MECHANICAL INSTALLATIONS	18
2.8 OPERATING AND MAINTENANCE INSTRUCTIONS FOR MECHANICAL INSTALLATIONS	18
2.9 GALVANIZING OF OUTDOOR STEEL STRUCTURES	19
2.10 GENERAL REQUIREMENTS, WORKMANSHIP, MATERIALS AND CONTRACT ADMIN (MECHANICAL INSTALLATIONS).....	20
2.11 ELECTRICAL WORK (FOR MECHANICAL INSTALLATIONS)	22
2.12 WATER SUPPLY.....	27
2.13 PRESSURE GAUGES.....	28
2.14 MATERIALS	28
2.15 PIPE JOINTS	28
2.16 WELDING	28
2.17 PREVENTION OF AIR LOCKS	28
2.18 DRAINS AND DRAIN COCKS	29
2.19 SLEEVES AND PIPE SUPPORTS	29
2.20 BLOCK PLAN	29
2.21 TESTING.....	29
2.22 PAINTING	29
2.23 FRAMED INSTRUCTIONS.....	30
2.24 OPERATING AND MAINTENANCE INSTRUCTIONS	30
2.25 CUTTING OF PIPES	30
2.26 INSPECTION AND MAINTENANCE	30

	New Libraries for the Limpopo Department of Sports, Art and Culture (DSAC) Library Name: LDPWRI-PROF/18005	Rev	00
		SQET File	
		ECSA Stage	4
		Discipline	Mechanical

GENERAL SPECIFICATIONS

1 GENERAL ADMINISTRATIVE REQUIREMENTS

1.1 GENERAL

This Standard Specification shall be read in conjunction with the Bills of Quantities, if any, the Project Specification and Drawings, in which the exact extent of the work will be identified.

1.2 CONFIDENTIALITY

All drawings, memoranda, ideas and information supplied for the works shall remain the property of the party so supplying such drawings, memoranda, ideas and information on the express understanding that they will be treated as private and confidential and not be used in any way, except in connection with the single installation for which they are intended

No details of any drawings, memoranda, ideas and information shall be published or disclosed in any trade or technical paper or elsewhere without the previous consent in writing of the party that supplied such drawings, memoranda, ideas and information.

1.3 DEVIATIONS FROM STANDARD SPECIFICATION

The quality of workmanship, materials to be used, equipment etc., shall be as specified in these documents. Where discrepancies exist between the Bills of Quantities, the Standard Specification and the Detailed Specification, the Detailed Specification shall have preference over both the Bills of Quantities and Standard Specification. The Standard Specification shall furthermore have preference over the Bills of Quantities.

Any discrepancies found between the Bills of Quantities, Standard and Detailed Specifications shall be brought to the attention of the Quantity Surveyor and Engineer in writing within seven (7) days of its discovery.

1.4 COMPLIANCE WITH REGULATIONS

The works shall comply with all the requirements and bylaws of the relevant local authorities. Where the proposed layouts, or any of the materials specified, etc., do not comply with the regulations, the matter shall immediately be brought to the attention of the Engineer in writing.

The complete works shall comply in particular with the specifications and requirements of:

1. All South African National Standards associated with the construction and safety of wet services installations and associated equipment.
2. The Occupational Health and Safety Act, Act 85 of 1993, as amended.
3. The appropriate South African National Standards governing building regulations.
4. The South African National Standards applicable to the wiring of premises.
5. This detailed specification and the drawings forming part of the tender documents.

Certificates of approval from the local authority, if called for, shall be delivered to the Engineer and/or Quantity Surveyor before the final payment certificate shall be issued.

	New Libraries for the Limpopo Department of Sports, Art and Culture (DSAC) Library Name: LDPWRI-PROF/18005	Rev	00
		SQET File	
		ECSA Stage	4
		Discipline	Mechanical

1.5 MUNICIPAL CONNECTIONS

The Sub-contractor shall make application, with the relevant local authority for the municipal mains connection, complete with all meter(s), necessary valves, valve chamber, etc. as directed by the local authority.

The connection(s) details are described in the Detailed Specification and/or drawings.

1.6 MUNICIPAL COSTS

The cost of the municipal connection, inspection fees, or any other charges levied by the local authority shall be borne by the Sub-contractor.

Where a Provisional Sum has been allowed for these costs, the plumbing Sub-contractor shall obtain a firm price from the local authority on award of the subcontract, and advise the Engineer and Quantity Surveyor of these costs in writing.

1.7 MAKE OF EQUIPMENT

Similar items of equipment used throughout this contract shall be of the same make and, where applicable, of the same model.

1.8 MATERIALS, WORKMANSHIP AND ALTERNATIVE MANUFACTURE

Materials, workmanship and equipment offered shall be as specified herein. Should the tenderer wish to offer alternative materials, equipment, etc., the details shall be submitted at close of tender in a covering letter accompanying the tender and clearly identifying the extent, quality and advantages of the alternative(s).

All materials shall be of the qualities specified and the Sub-contractor shall, upon request by the engineer, furnish the engineer with proof to his reasonable satisfaction that the materials are of the specified quality

The Sub-contractor shall keep the contractor and the engineer informed regarding the placing of all orders for materials and the progress of manufacture or any article or materials

All materials shall be new unless otherwise instructed or specified.

Materials, goods and equipment described by trade names or catalogue references shall be of the type and manufacture specified. Alternative materials, goods and equipment equal to those specified may be offered. The decision whether the alternative articles are acceptable shall rest with the engineer

Where alternatives for such materials, goods and equipment are permitted, the Sub-contractor shall be liable for latent defects in such materials, goods and equipment and or the cost of making good physical loss and repairing damage to the works resulting therefrom.

Once accepted, the same type and make of material, goods and/or equipment shall be used and installed throughout the project for a specific application.

	New Libraries for the Limpopo Department of Sports, Art and Culture (DSAC) Library Name: LDPWRI-PROF/18005	Rev	00
		SQET File	
		ECSA Stage	4
		Discipline	Mechanical

1.9 DRAWINGS, BUILDER'S WORK AND CO-ORDINATION WITH OTHER TRADES

The principal agent and/or architect is responsible for the primary coordination of the design elements and the Sub-contractor shall cooperate in the detailed coordination while preparing his shop drawings.

The drawings applicable to the works where relevant shall consist of:

1. The wet services engineer's drawings.
2. The architect's drawings.
3. The structural engineer's drawings.
4. Consultant's drawings of other disciplines.
5. The drawings of other service installations that are relevant for co-ordination and installation purposes.
6. The installation drawings of other Sub-contractors, where applicable.

Electronic copies of the engineer's drawings, specifications and schedules and relevant drawings of other agents shall be issued to the Sub-contractor for information and for installation purposes.

The physical sizes of the equipment offered shall be suitable for the locations shown on the drawings and shall be positioned in such a manner to ensure reasonable access all around the equipment for maintenance purposes and as may be recommended by the suppliers of the equipment.

The Sub-contractor shall, at tender stage, check and ensure that enough space has been allocated for the erection of his equipment and services, taking note of other services sharing the same space. Should the spaces indicated on the Engineer's drawings not be adequate, the tenderers shall at the time of tender advise the Engineer accordingly and, where relevant, submit with their tenders a sketch indicating the required space.

The Sub-contractor shall plan his work in advance and shall coordinate all space requirements in conjunction with the Principal Contractor, especially where other trades share the same space. Where conflicts occur, the Sub-contractor shall request clarification from the Architect and/or Engineer.

Provision will be made in the design of the building structure to accommodate the specified installation. The Sub-contractor shall supply to the engineer two copies of Builder's work drawing, or marked-up structural or other drawings detailing any changes and additional requirements such as holes, machine bases, chases, recesses, service ducts, wooden sleeves and frames, etc., as herein identified being provided by others and which will be required to accommodate his services, plant and materials. This information is to be supplied timeously to the engineer in accordance with the design and construction programme.

No structural element shall be erected and no holes shall be cut or made through the structure and no items of equipment shall be supported from the structure without the prior approval of the Structural Engineer or at least the Principal Contractor. Where foundations, machine bases, drained ducts, floor channels, cable sleeves, etc., have been identified herein to be provided by others, the Sub-contractor shall liaise and assist the Principal Contractor or others in setting out, locating, etc., of these items.

The Sub-contractor shall be responsible for the cost of all cutting, patching, making good, etc., as may be required to accommodate his work due to late or wrong information been given by the Sub-contractor.

Formal shop drawings need not be prepared by the Sub-contractor, but copies of the engineer's drawings shall be marked up by the Sub-contractor and submitted via the contractor to the engineer for approval. These approved marked-up drawings shall be considered to be the working drawings. The engineer's approval of

	New Libraries for the Limpopo Department of Sports, Art and Culture (DSAC) Library Name: LDPWRI-PROF/18005	Rev	00
		SQET File	
		ECSA Stage	4
		Discipline	Mechanical

drawings or samples is limited to checking for conformity with design requirements. This shall not relieve the Sub-contractor of responsibility for erecting, installing, fitting or for deviating from the requirements of the agreement unless the Sub-contractor has informed the engineer in writing of such deviation at the time of submission of drawings or samples, and the engineer has given written approval for the specific deviation. The engineer's approval shall not relieve the Sub-contractor of responsibility for errors or omissions in the drawings or samples.

Any work installed before approval of working drawings may be liable for removal at the engineer's discretion.

The engineer's drawings and specifications shall be considered binding with regard to the quality, quantity, general scheme system, arrangement and function of the works. All dimensions specially marked on the drawings shall be strictly followed.

1.10 CONFIRMATION OF ISSUES

Notwithstanding anything to the contrary as may be set down in the Subcontract Agreement, but rather as an extension to these clauses, it will be in the interest of the Sub-contractor to ensure that any verbal instruction, directive, explanation, etc., given as well as any agreement made or whatever, whether it will involve a variation or not, is confirmed in writing by the Engineer and/or the Principal Contractor within 14 days of it being given or made.

Failure on the side of the Sub-contractor to do so may invalidate any claim for a variation to the works and additional payment.

1.11 OTHER ENGINEERING CONTRACTS

Where water supplies and drainage are requested for air-conditioning plants, water softeners, boilers, calorifiers, hot water tanks, sterilisers and similar equipment provided outside the scope of the plumbing Sub-contractor's work, the extent of the plumbing Sub-contractor's responsibility will be as stated in the Project Specification.

The plumbing Sub-contractor shall, unless otherwise instructed in the Project Specification, terminate his piping with isolating valves in the positions indicated on the drawings.

1.12 NOISE

All water systems, including all mechanical equipment installed in said system, shall be free from objectionable noises, such as water hammer, etc. The Sub-contractor shall in the installation of all materials and equipment, and at commissioning, ensure the above.

Any equipment generating unacceptable noises, in the opinion of the Engineer, shall be corrected or dampened as directed by the Engineer at no additional cost to the subcontract.

1.13 PROTECTION

The Sub-contractor shall protect all work and material, i.e. his and others, from damage by his work and workmen, and shall be liable for all damage caused should the protection not be provided or prove to be

	New Libraries for the Limpopo Department of Sports, Art and Culture (DSAC) Library Name: LDPWRI-PROF/18005	Rev	00
		SQET File	
		ECSA Stage	4
		Discipline	Mechanical

inadequate. The Sub-contractor's responsibility in this respect shall extend until his work and equipment have been finally inspected, tested and accepted.

Open ends of pipework shall be closed with temporary covers or plugs during storage and construction to prevent entry of obstructing material. This shall be strictly enforced.

1.14 TESTING AND INSPECTIONS

The plumbing Sub-contractor shall, at his own cost, make all necessary arrangements and provide all necessary facilities for testing and inspection of the installation by the local authorities concerned and other authorised interested parties. The plumbing Sub-contractor shall provide any instruments or equipment required for these tests. The execution of these tests shall be to the complete satisfaction of the inspecting authorities/parties.

1.15 TUITION

The sub-contractor shall provide capable instructor/s to train the client's personnel. The instructor/s shall be available for a total period of 1 (one) working day (eight hours) after the system has been commissioned and handed over to the client. The Operating and Maintenance Manuals shall be in possession of the client before the training commences.

Training provided must include:

1. Information provided in the Design Intent Report (including energy / environmental features)
2. Review of controls set up, programming, alarms and troubleshooting
3. Review of O&M manuals
4. Building operation (start up, normal operation, unoccupied operation, seasonal changeover, shutdown)
5. Measures that can be taken to optimise energy efficiency
6. Occupational Health and Safety (OH&S) issues
7. Maintenance requirements and sourcing replacements; and
8. Obtaining and addressing occupant satisfaction feedback

1.16 GUARANTEE AND MAINTENANCE

The Sub-contractor shall guarantee the works against defects for a period of one (1) year from date of completion.

The guarantee shall cover all defects to the works and shall provide for the replacement or repair of all components that become defective during the guarantee period. Consumable components are excluded from the guarantee.

Where component parts or equipment are supplied by the employer, the contractor or the agent or where the make is specified without an alternative, then the Sub-contractor shall be responsible for such component parts or equipment only to the extent that the Sub-contractor is able to assign to the employer the benefit of warranties by the supplier or manufacturer.

	New Libraries for the Limpopo Department of Sports, Art and Culture (DSAC) Library Name: LDPWRI-PROF/18005	Rev	00
		SQET File	
		ECSA Stage	4
		Discipline	Mechanical

The works is to be operated and maintained in accordance with the Operating and Maintenance Manuals prepared by the Sub-contractor. Any damage to the works resulting from the employer's failure to comply with the procedures set out in these manuals will not be covered by the guarantee.

The sub-contractor shall provide free maintenance for a period of 1 (one) year following the hand over to the client. The maintenance shall include for all management, labour, lubricating materials, cleaning materials and transport.

The guarantee shall be given to the Principle Contractor. Where the guarantee period extends beyond the patent defects liability period of the Principal Building Agreement, the guarantee shall be ceded to the employer for the remainder of the period.

	New Libraries for the Limpopo Department of Sports, Art and Culture (DSAC) Library Name: LDPWRI-PROF/18005	Rev	00
		SQET File	
		ECSA Stage	4
		Discipline	Mechanical

TECHNICAL SPECIFICATIONS

2 FIRE PROTECTION

2.1 GENERAL

2.1.1 Site

This specification makes provision for the Fire Protection installations for the Library Facility

2.1.2 Description of Building Construction

Construction of Library Facilities. See drawings.

2.2 SCOPE OF CONTRACT

General fire fighting equipment, automatic fire sprinkler installation and signs for fire protection.

- Fire hydrants
- Fire hose reels
- Fire extinguishers
- Fire signage

Fire signage and internal water reticulation as per drawings. Civil contractor to do external water/erf connection and provide Ø100mm connection point as per drawing.

2.3 DRAWINGS

2.3.1 Definition

Tender drawings forms part of the specification. The drawings are numbered as follows:

DRAWING NO	DESCRIPTION
	** Refer to Tender Drawings

Dimensions and design data shown on tender drawings are for tendering purposes only. These drawings are not suitable for manufacturing purposes. The responsibility for dimensional accuracy remains with the Sub-Contractor.

2.3.2 Services

These clauses are relevant to all of the following engineering disciplines:

- Mechanical installations

	New Libraries for the Limpopo Department of Sports, Art and Culture (DSAC) Library Name: LDPWRI-PROF/18005	Rev	00
		SQET File	
		ECSA Stage	4
		Discipline	Mechanical

- Plumbing and drainage installations
- Fire Protection Installations

2.3.3 Engineering Drawings

The consulting engineer's drawings are not to be used for manufacturing or installation purposes. Sepias or copies of Engineers drawings may not be used by the sub-contractor for purposes of producing working drawings without the permission of the Engineer.

2.3.4 Sub-Contractor's Responsibility

The sub-contractor shall produce, at his own expense, all required drawings for the execution of the contract, including any additional details that may be requested by the engineer, architect or main contractor. He shall be responsible for the design, location and dimensioning of the installation.

Verification that the positioning or location of equipment, opening sleeves, penetrations, ducting, piping, etc. do not clash with other services is the responsibility of the sub-contractor.

2.3.5 Standards

General arrangement, installation and plant room layout drawings will be prepared to a scale of 1:250.

Enlarged details prepared for clarification shall be drawn to a scale of 1:20 or 1:10.

The smallest drawing sheet size consistent with clarity and un-ambiguity selected from the following shall be used: A0 / A1 / A3.

2.3.6 Approval

The sub-contractor shall not issue any original or revised drawings, to any parties, for information, manufacture, installation or for any other reason, unless such drawing has been checked by and stamped with the Engineer's mark of approval.

The Engineer will check drawings for correctness and compliance with design only. Physical sizes and correct location of equipment and components shall remain the responsibility of the sub-contractor.

Corrections or comments made on drawings by the Engineer do not imply a change in the "Scope of Work". The sub-contractor shall inform the Engineer immediately, in writing, prior to modifications to the original drawings, whether in his opinion such corrections and comments will result in a change to the "Scope of Work".

Three (3) prints of each drawing submitted for approval are required. The corrected print will be returned to the sub-contractor and shall be dealt with in accordance with the Engineer's stamped requirements.

The sub-contractor shall furnish as many prints of the approved drawings to the Architect, Main Contractor, or any other party specified for general issue.

	New Libraries for the Limpopo Department of Sports, Art and Culture (DSAC) Library Name: LDPWRI-PROF/18005	Rev	00
		SQET File	
		ECSA Stage	4
		Discipline	Mechanical

2.4 PAINTING AND FINISHING

2.4.1 General

All equipment, materials and fasteners installed under this contract shall be protected against rust, oxidization and corrosion by the application of an approved protective coating.

Such protective coatings shall be compatible with the materials applied to and shall at all times conform to the application instructions or recommendations of the manufacturer.

All aluminium equipment as well as Air handling units will be epoxy coated.

The appropriate and recommended primers shall be applied after de-scaling, cleaning, washing, drying or wiping as may be required and before finishing coats are applied.

Only the highest quality approved finishing, priming, etching and cleaning materials shall be used.

2.4.2 Piping Valves, Fittings and Equipment

Un-insulated piping, valves and fittings shall be coated with one coat specified primer, field applied after erection, and finished with two coats high gloss enamel.

Insulated piping shall be prime coated and inspected by the Engineer prior to insulation being applied.

Black steel or iron work shall be treated as for un-insulated piping.

Equipment supplied painted or coated by the manufacturer shall not be repainted unless so specified. Minor damaged areas may be spot coated with identical coatings supplied by the manufacturer.

Severely damaged equipment shall be re-coated to factory specifications.

2.4.3 Supports and Galvanized Items

All pipe work supports and brackets shall be of stainless steel grade 304 materials as specified in the ASIB rules. Galvanized surfaces shall be properly degreased, neutralized with water, painted with galvanized primer and painted with two coats of the colour specified.

2.4.4 Other Coatings

All coating materials not mentioned above such as electroplating, galvanizing, chroming, varnishing, rubberizing and other should be applied strictly in accordance with the manufacturer's specifications.

Piping – Fire

Hosereels	Signal Red G.7		Continuous	Continuous	-
Hydrants	Signal Red G.7		Continuous	Continuous	-
CO ₂	Signal Red G.7	Windsor Green G.33			-
Foam	Signal Red G.7	Medium Yellow G.6			-

	New Libraries for the Limpopo Department of Sports, Art and Culture (DSAC) Library Name: LDPWRI-PROF/18005	Rev	00
		SQET File	
		ECSA Stage	4
		Discipline	Mechanical

Miscellaneous

Bases – Steel/Steel Edge	Black G.2	-	-
Bases – Concrete Brackets	Black G.2	-	-
Drive Guards (Pump, Fan, etc.)	Calypso G.127	-	-
Motor Fan Guards	Calypso G.127	-	-
Handrails and Walkways	Aluminium	-	-
Motors	Manufacturer's Standard	-	-
Valve Wheels and Handles - Fire Services	Medium Yellow G.6	-	-
Valve Wheels and Handles - Other Services	Signal Red G.7	-	-
Plantroom Floors	Pale Grey (Gehopon) G.W.3762	-	-
Airtight Access Doors	Medium Yellow G.6	-	-

Equipment

Fire Protection Pumps	Manufacturer's Standard	-	-
-----------------------	-------------------------	---	---

2.5 CONTRACT MANAGEMENT OF MECHANICAL SUB-CONTRACTS

2.5.1 Co-Operation with Building Contractor and Other Contractors

Render full co-operation to the Principal Contractor and to other Sub-Contractors. Provide any information necessary to permit work of all trades to be installed satisfactorily and without interference or delay.

Where work is to be installed in close proximity to work of other trades, or where there is evidence that work may interfere with work of other trades, assist in resolving co-ordination issues to make satisfactory adjustment prior to preparation of shop drawings.

The program and progress of Building Contractor will largely dictate the program and order of work to be followed by the mechanical Contractor. The mechanical Contractor is therefore required to collaborate closely with the Building Contractor and other Sub-Contractors and in many instances will have to sub-ordinate his preferred order of work or program to suit the requirements of the Building Contractor and the contract as a whole.

2.5.2 Supervision

In addition to the requirements of the Conditions of Tender and Conditions of Sub-Contract, the Sub-Contractor shall supply the services of an experienced and competent Contract Supervisor to be in constant charge of work at site.

2.5.3 Handling of Equipment

Investigate each space through which equipment must be moved or handled. Where necessary, equipment shall be transported from manufacturer in crated sections of size suitable for moving through restricted spaces available.

2.5.4 Temporary Use of Equipment

	New Libraries for the Limpopo Department of Sports, Art and Culture (DSAC) Library Name: LDPWRI-PROF/18005	Rev	00
		SQET File	
		ECSA Stage	4
		Discipline	Mechanical

No equipment intended for permanent installation shall be operated for temporary purposes, without the written permission of, and in complete agreement with stipulations, as set for by the Architect and/or Engineer.

2.5.5 Storage of Materials

In addition to the requirements of the Conditions of Tender and Conditions of Sub-Contract, the following shall apply:

Materials permitted to be stored within building shall be safely stacked and shall not overload floor construction beyond the legal permissible floor loading.

Combustible materials shall not be stored on premises longer than minimum period necessary for execution of work. Provide fire protective measures as directed by Principal Agent and/or Principal Contractor.

2.5.6 Handover Inspections

The Sub-Contractor must allow for reasonable assistance to the Engineer during inspections.

The installation will be inspected by the Engineer on a regular basis during the course of the Contract to ensure compliance with this specification. A written record will be kept of all defects noted.

The Sub-Contractor shall provide a competent person to accompany the Engineer or his representative during inspections. This person shall know the installation, shall be in a position to accept and carry out instructions and shall take notes during the inspections so that the remedial work can commence immediately and is not held up while waiting for the inspection certificate.

On completion of the sub-contract works, final physical inspections will be carried out as commissioning proceeds. Any deviation from specification or below standard workmanship is to be rectified to the satisfaction of the Engineer by the Contractor, prior to requesting a Certificate of Practical Completion.

The Sub-Contractor must replace any portion of the installation that does not meet with the requirements of this Specification as may be imposed thereon by test or inspection. Such replacements shall be done at his own cost.

A certificate of Practical Completion will be issued when the sub-contract works are to all intents and purposes complete, commissioned and available for beneficial use by the Owner. (The date of this Certificate will determine the commencement of the guarantee period.)

A Certificate of Final Completion will only be issued when all defects listed at the time of partial completion have been complied with. The issue of this Certificate will coincide with certification of payment of the full contract sum (excluding retention).

The Sub-Contractor must ensure that the installation is correct, complete and to specification before calling for acceptance inspections.

Recording charts of all tests by the Contractor must be submitted to the Engineer before applying for acceptance inspections.

The cost of any abortive inspections, where the Engineer is called to site, but finds the sub-Contractor ill-prepared for it, may be deducted from the Contract Price by Variation Order.

	New Libraries for the Limpopo Department of Sports, Art and Culture (DSAC) Library Name: LDPWRI-PROF/18005	Rev	00
		SQET File	
		ECSA Stage	4
		Discipline	Mechanical

The Engineer can request that any part of the system of the complete system be retested, recorded and measured as part of the acceptance inspections if there exists reasonable doubt about the accuracy of the test.

2.5.7 Guarantee

The Sub-Contractor shall guarantee the material, apparatus and workmanship delivered by him for a period of twelve months. The guarantee must be valid for a period starting on the date when the Contract is accepted by the Engineer as complete and in working condition as defined in Clause 3.6. The complete installation must be guaranteed against defects as a result of patent and latent defects of the design and apparatus, (save design defects made or specified by the Engineer), as well as against faulty materials and workmanship. The guarantee must provide that all parts, spares and appurtenances that become defective during the guarantee period be replaced free of charge.

The costs of labour and transportation required to replace such part of a defective installation shall be borne by the Contractor and shall be included in his guarantee. The Contractor shall cede to the Employer the remainder of any equipment guarantee, which he has received from his suppliers, which extend beyond the period of twelve months mentioned herein.

In the event of the project being phased, guarantee on installation and equipment shall commence on the date on which it is put into operation for beneficial use to the satisfaction of the Engineer.

2.6 TESTING AND COMMISSIONING OF MECHANICAL INSTALLATIONS

2.6.1 General

The sub-Contractor shall test, balance and commission the installation as required to achieve specified performance and efficient operation of the system and record all details of measurements taken. A responsible Commissioning Engineer employed by the Sub-Contractor shall be present to supervise the operation and adjustment of the equipment during the entire commissioning stage.

The Sub-Contractor shall carry out all of the above before requesting acceptance and witnessing of performance by the Engineer. Commissioning data shall be fully tabulated in conjunction with the design data and submitted to the Engineer prior to the inspection being carried out by the Engineer.

Commissioning of equipment and systems shall not be undertaken if damage to the equipment, systems or the building could result due to incomplete and incorrect installation work.

Commissioning procedures as stipulated by the suppliers of equipment shall be strictly adhered to.

The commissioning of equipment such as refrigeration machines, boilers, air compressors, etc. shall be undertaken by the suppliers under the supervision of the Sub-Contractor.

Calibrated instrumentation required to measure flows, pressures, temperatures, etc. shall be provided by the Contractor.

The entire control system shall be adjusted and commissioned by the control system specialist contractors, where applicable.

All safety protection systems shall be fully commissioned and set points properly checked out and adjusted, before equipment shall be allowed to run for commissioning purposes.

	New Libraries for the Limpopo Department of Sports, Art and Culture (DSAC) Library Name: LDPWRI-PROF/18005	Rev	00
		SQET File	
		ECSA Stage	4
		Discipline	Mechanical

2.6.2 Performance and Capacity Tests

Where the Engineer is to witness tests, the Sub-Contractor shall ensure that the Engineer receives reasonable notice that such tests will take place. Tests required to demonstrate specified capacity and general operating characteristics of all systems and equipment, shall be undertaken by the Sub-Contractor under the direction of the Engineer at time of final inspection.

	New Libraries for the Limpopo Department of Sports, Art and Culture (DSAC) Library Name: LDPWRI-PROF/18005	Rev	00
		SQET File	
		ECSA Stage	4
		Discipline	Mechanical

2.7 MAINTENANCE OF MECHANICAL INSTALLATIONS

The Sub-Contractor shall include in his Tender for the maintenance of the entire installation during visits at regular monthly intervals, for a period of ONE year after written acceptance of the plant by the Consulting Engineer and the issuing of a Certificate of Completion.

During such visits the Sub-Contractor shall perform the following duties, all his work being arranged during such normal working hours as will not unduly disturb the functions of the occupants of the areas concerned.

- Report to an official nominated by the Owners on arriving and again at leaving their premises on the occasions of each visit. Such person, who has been nominated by the Owners, shall sign a monthly Service Report prepared by the Sub-Contractor giving details of any defects made good, temperature readings taken, etc. A copy of such a Service Report is to be submitted to the Engineer.
- Check and clean filters as necessary. Allow for the replacement of one complete set of filters before the end of the maintenance period. The spare set is to be handed over before acceptance of the installation, and is to be installed when the efficiency of the original set has fallen below acceptable levels, or one month before the expiry of the maintenance period, whichever occurs first.
- Check all refrigeration systems for leaks, dryness and general performance and rectify defects.
- Check the function of each plant item including all automatic controls and safety devices for correct operation and make good any defect.
- Check electrical switchgear for dust, arcing or loose connections. Replace any pilot lamp bulbs, which have failed.
- Clean and inspect the system generally and lubricate all rotating equipment requiring such service.
- Make good any defects as required in terms of the guarantee given for the plant in terms of the specification.
- Check operation of water treatment systems, take samples for testing by water treatment system supplier, check level of chemicals, adjust dosage as necessary. Check bleed off rates and operation.
- Attend to any complaints made, with respect to the relevant mechanical plant, by the authorized person mentioned in the foregoing. The Contractor will not be obliged to act on the complaints or requests of any other person.
- Check wet and dry bulb temperatures in the conditioned spaces in at least four different locations, by means of a reliable sling psychrometer and record such readings in the Service Report previously mentioned herein.

2.8 OPERATING AND MAINTENANCE INSTRUCTIONS FOR MECHANICAL INSTALLATIONS

2.8.1 Manuals

A condition of the final acceptance of the works will be the provision of three copies of an approved comprehensive Maintenance and Operating Instruction Manual.

Each copy of the manual is to include the following:

	New Libraries for the Limpopo Department of Sports, Art and Culture (DSAC) Library Name: LDPWRI-PROF/18005	Rev	00
		SQET File	
		ECSA Stage	4
		Discipline	Mechanical

- A general description of the system and its operation.
- Details of the method of operation of the plant and controls.
- An equipment and controls list giving the following:
 - Description
 - Quantity
 - Make
 - Model Number
 - Location
- A schedule of the servicing to be done on each item of equipment and controls and the frequency.
- A log sheet giving the design parameters and provisions for the logging of these parameters by the plant operator.
- Description of automatic control system, accompanied by control schematics (where necessary).
- Step-by-step instructions for starting/stopping each item of equipment.
- A record of relevant readings taken during final commissioning and hand-over tests.
- "As-built" drawings, wiring diagrams, piping schematics.

2.8.2 Owner Instruction

The Sub-Contractor, in addition to the operating and maintenance manuals, shall give detailed explanation of and instructions to the Owner on the operation of the complete installation as finally commissioned and handed over.

The Sub-Contractor shall operate the whole plant for a period of five consecutive full working days after the plant is handed over. During this period, the Sub-Contractor shall instruct the Owner in the operation of the plant.

2.9 GALVANIZING OF OUTDOOR STEEL STRUCTURES

2.9.1 General

Outdoor steel structures shall be hot-dip galvanized in accordance with the requirements of SABS 763 (1977). The structures (or components that make up a structure) shall be construed to be class A1 articles in terms of the classification in SABS 763 and shall be coated to a minimum thickness of 85 micron corresponding to 595g/m².

Welded joints are to be assumed to be continuous, as defined by SABS 763.

2.9.2 Preparation

	New Libraries for the Limpopo Department of Sports, Art and Culture (DSAC) Library Name: LDPWRI-PROF/18005	Rev	00
		SQET File	
		ECSA Stage	4
		Discipline	Mechanical

Surfaces that are to be hot dip galvanized shall be thoroughly prepared by removing all welding scale, burrs and lumps and grinding smooth all welds, prior to cleaning. Articles shall be cleaned by hot alkaline degreasing following by pickling in hydrochloric acid to remove scale.

2.9.3 Galvanizing

Articles shall be fully immersed in the dipping tank – partial immersion to accommodate large articles is not permitted. The resulting coating shall be free from blemishes and defects, as permitted in SABS 763 and shall have the adherence and uniformity required by SABS 763.

2.9.4 Passivating

The galvanized articles shall be passivated immediately after dipping. Passivation shall be by immersion in a solution of 1% sodium dichromate and 0.5% sulphuric acid, or by other approved passivating agent.

2.9.5 Defects

Galvanizing faults due to defects in the rolled steel sections are to be repaired by grinding down to base metal and zinc spraying. The repair must be inspected and approved by the structure designer and be certified not to weaken the structural integrity of the component.

Components and structures shall be carefully inspected (prior to erection) for scratches and white rust. White rust may be removed by the use of a non-metallic brush and detergent, providing that during this process the zinc coating is not reduced to below that specified. When the coating is reduced below the specified thickness, it shall be over-coated by zinc spraying up to the required thickness. Surface scratches sustained during storage and transport is to be repaired by the use of a hot-patching solder stick.

2.9.6 Storage, Transport

Galvanized articles are to be handled and stored with due regard to the durability of the zinc coating. Articles shall not be dragged or dropped during transport and erection. Stacked articles shall have protection spacers between adjacent surfaces.

2.9.7 Assembly

When components are bolted together to form structures, a bituminous paint seal is to be applied between faces in contact so as to prevent the entrapment of moisture. Electrical continuity at these joints will be maintained by the use of separate tinned copper earthing strips, as specified elsewhere.

2.10 GENERAL REQUIREMENTS, WORKMANSHIP, MATERIALS AND CONTRACT ADMIN (MECHANICAL INSTALLATIONS)

2.10.1 General

The Sub-Contractor will be required to provide all labour, materials, equipment and services and perform all operations required for the complete installation of all heating, ventilating and air conditioning work as shown

	New Libraries for the Limpopo Department of Sports, Art and Culture (DSAC) Library Name: LDPWRI-PROF/18005	Rev	00
		SQET File	
		ECSA Stage	4
		Discipline	Mechanical

on the relevant drawings and in accordance with all applicable requirements of the Sub-Contract documents. This specification is of simplified form, and includes incomplete sentences. The omission of works or phrases shall be implied by inference.

The detailed Installation Specification, PORTION 3.5, takes precedence over this part of the specification should there be any conflict in description or requirements referred to in both parts.

2.10.2 Definitions and Abbreviations

Definitions of terms used herein:

“Provide”	To supply, install, connect and hand over complete and ready for safe and regular operation of particular work referred to unless specifically indicated otherwise.
“Install”	To erect, mount and connect, complete with all related accessories.
“Supply”	To purchase, procure, acquire and deliver, complete with all related accessories.
“Work”	All labour, materials, equipment, apparatus, controls, accessories and other items required for correct and complete installation.
“Piping”	Pipe, tube, fittings, flanges, valves, controls, strainers, hangers, supports, accessories, drains, insulation and all related items.
“Wiring”	Conduit, fittings, wire, junction and outlet boxes, switches, cut-outs, socket outlets and all related items.
“Concealed”	Embedded in masonry or other construction, installed in furred spaces, within double partitions or hung ceilings, in trenches, in crawl spaces or in enclosed spaces.
“Exposed”	Not installed underground or concealed as defined above.
“Indicated”, “Shown” or “Noted”	As indicated, shown or noted on drawings and/or specifications.
“Similar” or “Equal”	Of approved manufacture, equal in weight, size, design and efficiency of performance of the product specified or mentioned by name.
“Approved”, “Satisfactory”, “Accepted”	As approved, satisfactory or accepted by the Architect and/or Consulting Engineer.
“SABS”	South African Bureau of Standards.
“BSI”	British Standards Institution.
“ASHRAE”	American Society of Heating, Refrigeration and Air Conditioning Engineers.

	New Libraries for the Limpopo Department of Sports, Art and Culture (DSAC) Library Name: LDPWRI-PROF/18005	Rev	00
		SQET File	
		ECSA Stage	4
		Discipline	Mechanical

“ASME”	American Society for Testing Materials.
“ASA”	American Standards Association.
“NBS”	National Bureau of Standards (U.S.A.).
“NEMA”	National Electrical Manufacturers Association.
ASIB	Automatic Sprinkler Inspection Bureau.

2.11 ELECTRICAL WORK (FOR MECHANICAL INSTALLATIONS)

2.11.1 General

All electrical equipment shall be suitable for the declared voltage of the Supply Authority.

Unless otherwise specified, electrical energy will be brought to the Contractor’s local isolator or main switchboard by the Electrical Contractor. The supply and installation of electrical works from the local isolator or switchboard to the equipment shall form part of this contract.

2.11.2 Wiring Diagrams

Although covered elsewhere, specific mention is made of the provision of wiring diagrams.

Apart from submitting comprehensive wiring diagrams for approval prior to the commencement of control board manufacture, the Contractor is to provide on completion “as-built” wiring diagrams for all electrical work forming part of this contract.

Copies of these diagrams and those for manufactured equipment are to be included in the Operating and Maintenance Instruction manuals.

2.11.3 Notices and Fees

The Sub-Contractor shall give all notices required by and pay all necessary fees, including any inspection fees, which may be due to the Local Supply Authority.

	New Libraries for the Limpopo Department of Sports, Art and Culture (DSAC) Library Name: LDPWRI-PROF/18005	Rev	00
		SQET File	
		ECSA Stage	4
		Discipline	Mechanical

2.11.4 Electricity Supply

All equipment shall be capable of operating continuously under variations in the supply system of $\pm 5\%$ in the voltage and $\pm 5\%$ in the frequency. The system supply data is set out in the detailed installation specification.

2.11.5 Compliance with Regulations, Standards and Specifications

The complete electrical installation shall satisfy the Local Supply Authority and shall further comply with the Code of Practice for the Wiring of Premises as issued by the South African Bureau of Standards, the Local Supply Authority By-Laws and the requirements of the Manpower and Occupation Safety Act, Act 6 of 1983. The latter shall take precedence in the case of conflicting requirements.

Except where otherwise provided for in this specification, all equipment offered shall comply with the requirements of the relevant SABS standard specification, if published and shall bear the mark, otherwise with the relevant British Standards in force at the time of tendering, the specifications mentioned herein or shall otherwise be “approved”.

Where equipment offered complies with the recognized standards of the country of manufacture and not specifically with the standards required by this specification, such equipment will be considered at the discretion of the Engineer. In this case, Tenderers shall state fully, all respects in which the equipment offered departs from the standards laid down in this specification.

2.11.6 Protection of Electrical Equipment

No piping shall pass through any Elevator Machine Room, Transformer Room, Emergency Generator Room, Switchboard Room or Electrical Duct.

In general no piping shall be located in the same room within 1,8m in plan view of any part of any electrical switchboard.

Where the above is not practical, protect electrical apparatus as follows:

Provide watertight drip pans of 1mm galvanized sheet metal, reinforced and properly supported, under all piping near electrical control boards. Provide 32mm drain outlet pipes to spill over nearest floor drain.

2.11.7 Standardization of Materials and Equipment

Wherever possible the equipment offered shall be of one make with the facility to interchange corresponding parts/components.

Materials and equipment used in this contract must, where possible, be of South African manufacture. The Sub-Contractor shall submit samples of any materials or equipment, if required, for approval before installation. Such samples will be held for comparison purposes with equipment and materials installed and will be released on satisfactory completion of the contract.

2.11.8 Conduit

Conduits shall enter distribution boards from above, unless otherwise specified.

	New Libraries for the Limpopo Department of Sports, Art and Culture (DSAC) Library Name: LDPWRI-PROF/18005	Rev	00
		SQET File	
		ECSA Stage	4
		Discipline	Mechanical

Mechanical and electrical continuity must be maintained throughout the conduit installation, although conduit shall NOT be relied upon for each continuity.

Conduits shall be screwed into outlets of conduit boxes where possible but where fixed to boxes they shall be secured by means of sockets and brass bushes passing through properly sized clearance holes.

All conduit ends shall be cut square to enable the conduits to be butted at all conduit sockets and joints and conduit threads shall not show at the joints or terminations except where running joints are made. All lubricants used to ease screwing shall be wiped off and oil shall not be used. The inside of conduits, the ends of conduits, and all fittings used in the connection therewith shall be smooth and free from burrs and all other defects. All exposed screw threads and parts where galvanized or paint finish has been damaged shall be thoroughly cleaned and painted with a zinc-rich paint for galvanized or a black bitumastic paint for black enamel conduits.

Conduits shall comply with SABS 1065-Part I.

All conduits shall be heavy gauge, screwed, welded seamless, or solid drawn, unless otherwise specified in the detailed installation specification. No conduit with less than 20mm external diameter shall be used.

Concealed conduit shall be finished black enamel but shall be galvanized for use externally for surface installation or where exposed to weather.

All junction boxes used in conjunction with steel conduit shall be of heavy steel or cast iron construction, to SABS 1065-Part II. Boxes for external use or in damp situations shall either be provided with gaskets or with machined faces and watertight covers. The use of inspection elbows, solid bends and tees will not be permitted except where shown on the drawings. All fittings used with galvanized conduit shall be galvanized. All screws shall be cadmium plated. All surface conduits shall be supported by cast distance saddles. Conduits shall be supported on both vertical and horizontal runs at 1500mm centers.

2.11.9 Cabling

Single core cables used in the wiring of building shall be 600/1000 Volt grade PVC insulated to SABS 150. The cables shall be from recent stocks and must be delivered on the site with seals unbroken and bearing the SABS mark.

Cables shall be sized accordingly to the duty they are to perform in accordance with the relevant standards.

Where multiple circuits or single core cables are run in parallel runs, the use of proprietary metallic wiring trunkings with PVC cables drawn in will be permitted. Such wiring trunks shall be totally enclosed, electrically continuous, bonded, provided with removable coverplates and fabricated from 43mm galvanized steel and provided with returned edges.

Connections to motors shall terminate in a short length of flexible conduit. Adaptaflex type SP, Kopex or equal and approved for dry conditions, Adaptaflex type SPL for conditions exposed to dust, watery suds or oils.

Earth continuity conductors shall be installed in all conduits and provided for all cables.

Terminals shall be enclosed in purpose-made terminal boxes. The terminal boxes shall be generously sized, metallic or approved non-metallic (e.g. dough moulding compound) and shall be provided with DIN mounting

	New Libraries for the Limpopo Department of Sports, Art and Culture (DSAC) Library Name: LDPWRI-PROF/18005	Rev	00
		SQET File	
		ECSA Stage	4
		Discipline	Mechanical

rail terminal blocks sized to requirements, terminal screws which do not act directly on the conductors, removable coverplates and adequate cable or conduit entries).

Multicore armoured cables shall be SWA, PVC to SABS 150-1970 or MICC to BS 6207 Part I and shall be fitted with maker's approved glands, and ends shall be properly made off.

Cable glands for PVC cables shall comply with the requirements of SABS 1213-1984 and shall bear the mark.

2.11.10 Cable Trays

In most circumstances, it will be permitted to run cable on a cable tray in which case the tray shall be manufactured of galvanized steel of not less than 1,6mm gauge.

Cable trays shall be complete with bends, tees, etc. and be continuous.

Cable trays shall be perforated galvanized steel with upstand 12mm high for up to 250mm wide trays and 50 high for wider trays.

Cable ladders similar and equal to Sankey Strut may also be used.

Trays shall be securely supported from ceilings or brackets and by means of screwed galvanized rods 10mm diameter and cross supporting angle or unistrut section, at intervals of 1500mm.

2.11.11 Testing of the Electrical Installation

Conduct such tests and adjustment of equipment as specified elsewhere, and as necessary to verify performance requirements, and as required by all Authorities having jurisdiction. Submit data taken during such tests to the Engineer. The Engineer reserves the right to be present during these tests and shall be notified 48 hours in advance.

Attend on the Engineer and give all assistance required and provide such tools, materials, implements and instruments as are necessary for the tests. The Engineer reserves the right to call for such additional tests as he may consider necessary.

Upon completion of work the electrical installation shall be tested for earthing and short circuits in accordance with the Code of Practice. If tests indicate inadequate insulation resistance, corrections shall be made as directed by the Engineer.

Insulation resistance values shall be not less than those specified in the Code of Practice.

Operational tests of electrical equipment shall be performed as directed by the Engineer and as specified elsewhere.

Notify and make arrangements with the officials of the Supply Authority for carrying out all municipal tests. Provide attendance, tools, staging and all other facilities to the Supply Authorities as may be required for the purpose of these tests. Should retesting be required by the Supply Authority pay all fees incurred by such test. The Engineer reserves the right to present at the tests and should be notified 48 hours in advance.

Certificates of Compliance shall be issued to the Engineer for all electrical work that was done by the Sub-Contractor.

	New Libraries for the Limpopo Department of Sports, Art and Culture (DSAC) Library Name: LDPWRI-PROF/18005	Rev	00
		SQET File	
		ECSA Stage	4
		Discipline	Mechanical

2.11.12 Electric Motors

General

All electric motors shall be constructed in accordance with the following requirements where applicable.

SABS 948 Part I - 1978: Three Phase Induction Motors

SABS 1189 - 1978: Single Phase Induction Motors

BS 4999 Index - 1977: Specification for General Requirements for
Issue 4 Rotating Electrical Machines

The mounting and coupling arrangement for the motors shall suit the plant layout, but adequate provision shall be made for ease of replacement of motors.

Motors shall be minimum Class F insulation.

Motor terminal boxes shall be adjustable to allow for cable entry from any one of three directions at 90° i.e. entrance from below or either side (not above) and for all forms of cable connections. It shall be possible to remove the motor. Terminal boxes shall be drilled and tapped to take two cable glands to SABS 1213-1984. Both holes shall be fitted with blank brass plugs.

The colour code for motors, guards, baseplates, pumps, etc. shall be standard manufacturer's ex-works paint finish unless specified otherwise.

Rating and Types

All motors shall be continuous maximum rated, three phase or single phase squirrel cage induction type, wound for duty on an earthed 380/400 or 220/230 Volt 50 Hz system.

All motors shall be rated for direct-on-line starting unless otherwise indicated. Speeds shall be suitable for the equipment to be driven. Motors shall be rated at not more than 1,3 times the designed mechanical load.

Rating plates shall be provided on all motors and shall be of stainless steel or a non-corrosive alloy.

Requirements for Various Environments

Indoor Wet:

Enclosure to IP55 degree of protection.

Windings to be treated with extra impregnation and baking.

Cable entry from below.

Motors with ratings in excess of 50kW to be fitted with heaters.

Frames shall be aluminium.

	New Libraries for the Limpopo Department of Sports, Art and Culture (DSAC) Library Name: LDPWRI-PROF/18005	Rev	00
		SQET File	
		ECSA Stage	4
		Discipline	Mechanical

Indoor Dry:

Enclosure to IP54 degree of protection.

Cable entry from bottom or sides.

Outdoor:

Enclosure to IP55 degree of protection.

Cable entry from below.

Motors with ratings in excess of 50kW to be fitted with heaters.

Frames shall be aluminium.

Caustic:

The entire housing, terminal box, fan cover, end shields and mounting foot or plate shall not be of aluminium construction.

Enclosure to IP55 degree of protection.

Dust Explosion Proof:

Enclosures and terminal boxes shall be suitable for CLASS 1 DIVISION 2 and be in accordance with SABS 0108 and SABS 314.

Enclosure group, in addition to the above, with be to IP54.

Variable Speed:

All motors intended for use in variable speed applications shall be fitted with integral positive temperature co-efficient or resistance type thermistors for the thermal protection of the windings.

One thermistor shall be fitted per phase and shall be wired in series with the ends brought out to the terminal box.

The terminal box shall be large enough to accommodate both the power and control cable glands.

2.12 WATER SUPPLY

A single water supply connection terminating in a plugged socket inside one of the fire cupboards, in accordance with the drawings, will be supplied by others. A Booster Electric Back-Up will also be installed in accordance to the drawings with coordination with the Architect and Civil Engineer.

	New Libraries for the Limpopo Department of Sports, Art and Culture (DSAC) Library Name: LDPWRI-PROF/18005	Rev	00
		SQET File	
		ECSA Stage	4
		Discipline	Mechanical

2.13 PRESSURE GAUGES

The two pressure gauges required for the installation shall be not less than 100 mm diameter with porcelain faces registering 1 500 kPa. They shall be so connected to the control valves that one registers the pressure in the municipal supply and the other the pressure in the system.

Their connections shall be taken from purpose made outlets on the valves and shall comprise a “U” tube without any fittings (elbows etc.) with all bends neatly executed. The gauges shall be fitted upright with brass shut-off cocks or other approved means of shut-off so as to permit their removal under pressure, if required.

2.14 MATERIALS

All piping, fittings and valves used in the installation shall be new and of an approved type capable of withstanding a test pressure of 2 000 kPa.

All piping shall be non-galvanised mild steel manufactured in accordance with SABS 62 (medium grade), unless otherwise specified and shall be of an approved brand and the best obtainable. All pipes shall be free of rust, flakes or other faults.

Notwithstanding the above stipulations, all underground/outdoor (canopies & etc.) pipes shall be galvanised in accordance with SABS 763.

2.15 PIPE JOINTS

All threaded pipe joints shall be made with an approved cold water pipe-jointing compound and flanges when used shall be bolted together with approved gaskets. Pipe threads shall be standard right-hand Whitworth. Mechanical pipe-joints i.e. “Klambon” or other pipe joints approved by the Engineer may be used provided they have been approved by the Automatic Sprinkler Inspection Bureau (A S I B) and are installed strictly in accordance with the instructions of the manufacturer.

2.16 WELDING

Welding in situ without the prior permission of the Main Contractor will not be permitted. If welding of any joint or joints is necessary on the site the reasons for this shall be clearly stated in the tender. Welded joints shall be properly machined and the use of a welding torch for making holes shall not be permitted.

Distribution pipes with welded crosses and tees shall be provided with female thread so that the branch pipes can be connected in the conventional way. Where pipe lengths exceed 14m they shall be fitted with flanges.

All welded joints shall be hydraulically tested to 2 000 kPa. Welded joints in branch pipes will not be permitted.

2.17 PREVENTION OF AIR LOCKS

In order to prevent the lodgement of air, a proper inclination of pipelines shall be maintained throughout the work.

	New Libraries for the Limpopo Department of Sports, Art and Culture (DSAC) Library Name: LDPWRI-PROF/18005	Rev	00
		SQET File	
		ECSA Stage	4
		Discipline	Mechanical

2.18 DRAINS AND DRAIN COCKS

Suitable drainpipes shall be provided for the 50mm outlet on the control valves and the 32mm outlet on the hydraulic alarms.

Where distribution pipes are lower than the control valves, each separate section of the system shall be provided with a 20mm drain pipe. The pipe shall be properly secured to the wall and roof and carried down and plugged within 2 metres of the floor.

2.19 SLEEVES AND PIPE SUPPORTS

Where sleeves and/or pipe supports are required, these will be provided by others.

All pipe supports, clamps and other suspension fittings shall be supplied and installed by the sprinkler contractor.

Distribution and branch pipes shall be properly secured and branch pipes shall be anchored within 0,7m from the last sprinkler head.

The Tenderer is required to provide a drawing showing full details of the sizes and manner of the suspension fittings, to the Engineer for its approval.

2.20 BLOCK PLAN

The block plan should be in black engraved letters on white perspex or stainless metal plate such as aluminium or stainless steel.

The block plan shall indicate only the buildings protected by the systems, which are served by the control valve or -valves in the particular valve cupboard. Should a building be served by valves in more than one valve cupboard, the block plan shall be provided in all valve cupboards with a clear indication of the position of the particular valve cupboard.

2.21 TESTING

The fire protection installation shall be tested to a hydraulic pressure of 350kPa and any defect made good.

2.22 PAINTING

Painting of all portions of the sprinkler installation, including all hangers, valves and hydraulic alarms shall form part of the sprinkler contract.

Before painting is undertaken, all work shall be thoroughly cleaned of rust, scale, etc., by brushing with a stiff wire brush wherever necessary. A prime coat of high-quality zinc chromate primer shall be applied before delivery to the site.

	New Libraries for the Limpopo Department of Sports, Art and Culture (DSAC) Library Name: LDPWRI-PROF/18005	Rev	00
		SQET File	
		ECSA Stage	4
		Discipline	Mechanical

After installation, all fittings shall also be primed with zinc chromate primer and where the primer has come off the pipes, these shall be re-primed whereafter two coats of high gloss paint shall be applied. Unless otherwise specified, the colour of the high gloss paint shall be similar to No. D 30 Post Office red of CKS 279. The final coat of paint shall be applied only after the system has been tested and the ceilings have been painted. The final coat shall not be applied without the express consent of the Engineer.

Pipe supports and other fittings, which are not directly in contact with the pipe work, shall be painted the same colour as the ceilings or beams. The Engineer is to be consulted in this regard.

The hydraulic alarm shall be painted with a prime coat and two coats of high gloss red paint as stated above. The words 'FIRE' and 'BRAND' shall appear thereon in white letters, 100mm in height. Should the construction of the alarm be such that it is impossible or difficult to paint the letters thereon, these shall be painted on a suitable steel plate and attached to the wall in a clearly visible position.

2.23 FRAMED INSTRUCTIONS

A diagrammatic instruction chart clearly indicating the procedure for operating the sprinkler valves, in both official languages, shall be mounted in a strong teak or approved metal frame with Perspex front on the inside of the door to the valve cup-board.

The minimum design pressure of the system shall be clearly indicated on the chart.

2.24 OPERATING AND MAINTENANCE INSTRUCTIONS

Full installation operating and maintenance instructions shall be supplied in triplicate with each system and shall include schematics and detailed wiring drawings with a full component list indicating not only component values but sources of supply.

2.25 CUTTING OF PIPES

Contractors using conventional pipe cutters are warned that all burrs and lips are to be removed by proper reaming of the cut end before threading to ensure that the original diameter is obtained.

Any pipes with ends of reduced diameter found on the site shall be removed and the Contractor may be required to dismantle completed work so as to convince the Engineer that no such pipes were used elsewhere in the installation.

2.26 INSPECTION AND MAINTENANCE

Tenderers shall provide and allow for a full inspection of the sprinkler installation by the Automatic Sprinkler Inspection Bureau (ASIB) or any other organisation recommended or approved by the Engineer, before the date of the initial taking over of the system.

Tenderers shall also provide and allow for three complete inspections with alarm tests every three months and for alarm tests only during the other eight months of the period of free maintenance.

	New Libraries for the Limpopo Department of Sports, Art and Culture (DSAC) Library Name: LDPWRI-PROF/18005	Rev	00
		SQET File	
		ECSA Stage	4
		Discipline	Mechanical

All such inspections and tests shall be carried out by the Automatic Sprinkler Inspection Bureau (ASIB) and not by the Contractor.



LIMPOPO

PROVINCIAL GOVERNMENT
REPUBLIC OF SOUTH AFRICA

DEPARTMENT OF
PUBLIC WORKS, ROADS & INFRASTRUCTURE

PROJECT NAME NEW LIBRARIES FOR THE LIMPOPO DEPARTMENT OF SPORTS, ART AND CULTURE (DSAC) AT THE FOLLOWING LOCATIONS: BOTSHABELO (WATERBERG DISTRICT), TSHAULU (VHEMBE DISTRICT), SEKHUKHUNE DISTRICT AND VLEIFONTEIN (VHEMBE DISTRICT)

LIBRARY NAME ALL SITES

PROJECT NO. LDPWRI-PROF/18005

DOCUMENT TITLE SPECIFICATIONS FOR MECHANICAL INSTALLATIONS

PART NUMBER 3 – TECHNICAL SPECIFICATIONS
3.3 WET SERVICES

REVISION 00

EMPLOYER	CONSULTING ENGINEERS
LIMPOPO DEPARTMENT OF PUBLIC WORKS AND INFRASTRUCTURE 43 CHURCH STREET POLOKWANE 0700	SUPERIOR QUALITY ENGINEERING AND TECHNOLOGIES 60 MAGAZYN STREET POLOKWANE 0699

SEPTEMBER 2021

	New Libraries for the Limpopo Department of Sports, Art and Culture (DSAC) Library Name: LDPWRI-PROF/18005	Rev	00
		SQET File	
		ECSA Stage	4
		Discipline	Mechanical

DOCUMENT CONTROL

Project Name	New Libraries for the Limpopo Department of Sports, Art and Culture (DSAC) at the following locations: Botshabelo (Waterberg District), Tshaulu (Vhembe District), Sekhukhune district and Vleifontein (Vhembe District)
Project Number	LDPWRI-PROF/18005
Library Name	-
Client Name	New Limpopo Department of Public Works and Infrastructure

ECSA Project Stage	Stage 4: Specifications
Document Type	Specifications For Mechanical Installations
Part Number	3 – Technical Specifications 3.3 Wet Services
Installations	Mechanical
SQET File Number	

	COMPILED	REVIEWED	SIGNED	APPROVED
NAME	T. C Mango	T. Magada	B. Nyambiya	
ORGANISATION	SQET	SQET	SQET	
DESIGNATION	Lead Engineer	Project Engineer	Principal Engineer	
DATE	06 September 2021	07 September 2021	09 September 2021	

	New Libraries for the Limpopo Department of Sports, Art and Culture (DSAC) Library Name: LDPWRI-PROF/18005	Rev	00
		SQET File	
		ECSA Stage	4
		Discipline	Mechanical

TECHNICAL SPECIFICATION

CONTENTS

DOCUMENT CONTROL	1
1 GENERAL ADMINISTRATIVE REQUIREMENTS	3
1.1 GENERAL	3
1.2 CONFIDENTIALITY	3
1.3 DEVIATIONS FROM STANDARD SPECIFICATION.....	3
1.4 COMPLIANCE WITH REGULATIONS	3
1.5 MUNICIPAL CONNECTIONS.....	4
1.6 MUNICIPAL COSTS	4
1.7 MAKE OF EQUIPMENT	4
1.8 MATERIALS, WORKMANSHIP AND ALTERNATIVE MANUFACTURE.....	4
1.9 DRAWINGS, BUILDER’S WORK AND CO-ORDINATION WITH OTHER TRADES.....	5
1.10 CONFIRMATION OF ISSUES	6
1.11 OTHER ENGINEERING CONTRACTS.....	6
1.12 NOISE.....	6
1.13 PROTECTION.....	6
1.14 TESTING AND INSPECTIONS.....	7
1.15 TUITION	7
1.16 GUARANTEE AND MAINTENANCE	7
2 WET SERVICES	9
2.1 PIPING	9
2.2 WATER EFFICIENCY.....	9
2.3 DOMESTIC WATER INSTALLATION.....	9
2.4 NON-POTABLE WATER STORAGE SYSTEM.....	10
2.5 SANITARY DRAINAGE INSTALLATION	10
2.6 WATER METERING STRATEGY	10
2.7 ASSOCIATED ELECTRICAL WORK.....	12

	New Libraries for the Limpopo Department of Sports, Art and Culture (DSAC) Library Name: LDPWRI-PROF/18005	Rev	00
		SQET File	
		ECSA Stage	4
		Discipline	Mechanical

GENERAL SPECIFICATIONS

1 GENERAL ADMINISTRATIVE REQUIREMENTS

1.1 GENERAL

This Standard Specification shall be read in conjunction with the Bills of Quantities, if any, the Project Specification and Drawings, in which the exact extent of the work will be identified.

1.2 CONFIDENTIALITY

All drawings, memoranda, ideas and information supplied for the works shall remain the property of the party so supplying such drawings, memoranda, ideas and information on the express understanding that they will be treated as private and confidential and not be used in any way, except in connection with the single installation for which they are intended

No details of any drawings, memoranda, ideas and information shall be published or disclosed in any trade or technical paper or elsewhere without the previous consent in writing of the party that supplied such drawings, memoranda, ideas and information.

1.3 DEVIATIONS FROM STANDARD SPECIFICATION

The quality of workmanship, materials to be used, equipment etc., shall be as specified in these documents. Where discrepancies exist between the Bills of Quantities, the Standard Specification and the Detailed Specification, the Detailed Specification shall have preference over both the Bills of Quantities and Standard Specification. The Standard Specification shall furthermore have preference over the Bills of Quantities.

Any discrepancies found between the Bills of Quantities, Standard and Detailed Specifications shall be brought to the attention of the Quantity Surveyor and Engineer in writing within seven (7) days of its discovery.

1.4 COMPLIANCE WITH REGULATIONS

The works shall comply with all the requirements and bylaws of the relevant local authorities. Where the proposed layouts, or any of the materials specified, etc., do not comply with the regulations, the matter shall immediately be brought to the attention of the Engineer in writing.

The complete works shall comply in particular with the specifications and requirements of:

1. All South African National Standards associated with the construction and safety of wet services installations and associated equipment.
2. The Occupational Health and Safety Act, Act 85 of 1993, as amended.
3. The appropriate South African National Standards governing building regulations.
4. The South African National Standards applicable to the wiring of premises.
5. This detailed specification and the drawings forming part of the tender documents.

Certificates of approval from the local authority, if called for, shall be delivered to the Engineer and/or Quantity Surveyor before the final payment certificate shall be issued.

	New Libraries for the Limpopo Department of Sports, Art and Culture (DSAC) Library Name: LDPWRI-PROF/18005	Rev	00
		SQET File	
		ECSA Stage	4
		Discipline	Mechanical

1.5 MUNICIPAL CONNECTIONS

The Sub-contractor shall make application, with the relevant local authority for the municipal mains connection, complete with all meter(s), necessary valves, valve chamber, etc. as directed by the local authority.

The connection(s) details are described in the Detailed Specification and/or drawings.

1.6 MUNICIPAL COSTS

The cost of the municipal connection, inspection fees, or any other charges levied by the local authority shall be borne by the Sub-contractor.

Where a Provisional Sum has been allowed for these costs, the plumbing Sub-contractor shall obtain a firm price from the local authority on award of the subcontract, and advise the Engineer and Quantity Surveyor of these costs in writing.

1.7 MAKE OF EQUIPMENT

Similar items of equipment used throughout this contract shall be of the same make and, where applicable, of the same model.

1.8 MATERIALS, WORKMANSHIP AND ALTERNATIVE MANUFACTURE

Materials, workmanship and equipment offered shall be as specified herein. Should the tenderer wish to offer alternative materials, equipment, etc., the details shall be submitted at close of tender in a covering letter accompanying the tender and clearly identifying the extent, quality and advantages of the alternative(s).

All materials shall be of the qualities specified and the Sub-contractor shall, upon request by the engineer, furnish the engineer with proof to his reasonable satisfaction that the materials are of the specified quality

The Sub-contractor shall keep the contractor and the engineer informed regarding the placing of all orders for materials and the progress of manufacture or any article or materials

All materials shall be new unless otherwise instructed or specified.

Materials, goods and equipment described by trade names or catalogue references shall be of the type and manufacture specified. Alternative materials, goods and equipment equal to those specified may be offered. The decision whether the alternative articles are acceptable shall rest with the engineer

Where alternatives for such materials, goods and equipment are permitted, the Sub-contractor shall be liable for latent defects in such materials, goods and equipment and or the cost of making good physical loss and repairing damage to the works resulting therefrom.

Once accepted, the same type and make of material, goods and/or equipment shall be used and installed throughout the project for a specific application.

	New Libraries for the Limpopo Department of Sports, Art and Culture (DSAC) Library Name: LDPWRI-PROF/18005	Rev	00
		SQET File	
		ECSA Stage	4
		Discipline	Mechanical

1.9 DRAWINGS, BUILDER'S WORK AND CO-ORDINATION WITH OTHER TRADES

The principal agent and/or architect is responsible for the primary coordination of the design elements and the Sub-contractor shall cooperate in the detailed coordination while preparing his shop drawings.

The drawings applicable to the works where relevant shall consist of:

1. The wet services engineer's drawings.
2. The architect's drawings.
3. The structural engineer's drawings.
4. Consultant's drawings of other disciplines.
5. The drawings of other service installations that are relevant for co-ordination and installation purposes.
6. The installation drawings of other Sub-contractors, where applicable.

Electronic copies of the engineer's drawings, specifications and schedules and relevant drawings of other agents shall be issued to the Sub-contractor for information and for installation purposes.

The physical sizes of the equipment offered shall be suitable for the locations shown on the drawings and shall be positioned in such a manner to ensure reasonable access all around the equipment for maintenance purposes and as may be recommended by the suppliers of the equipment.

The Sub-contractor shall, at tender stage, check and ensure that enough space has been allocated for the erection of his equipment and services, taking note of other services sharing the same space. Should the spaces indicated on the Engineer's drawings not be adequate, the tenderers shall at the time of tender advise the Engineer accordingly and, where relevant, submit with their tenders a sketch indicating the required space.

The Sub-contractor shall plan his work in advance and shall coordinate all space requirements in conjunction with the Principal Contractor, especially where other trades share the same space. Where conflicts occur, the Sub-contractor shall request clarification from the Architect and/or Engineer.

Provision will be made in the design of the building structure to accommodate the specified installation. The Sub-contractor shall supply to the engineer two copies of Builder's work drawing, or marked-up structural or other drawings detailing any changes and additional requirements such as holes, machine bases, chases, recesses, service ducts, wooden sleeves and frames, etc., as herein identified being provided by others and which will be required to accommodate his services, plant and materials. This information is to be supplied timeously to the engineer in accordance with the design and construction programme.

No structural element shall be erected and no holes shall be cut or made through the structure and no items of equipment shall be supported from the structure without the prior approval of the Structural Engineer or at least the Principal Contractor. Where foundations, machine bases, drained ducts, floor channels, cable sleeves, etc., have been identified herein to be provided by others, the Sub-contractor shall liaise and assist the Principal Contractor or others in setting out, locating, etc., of these items.

The Sub-contractor shall be responsible for the cost of all cutting, patching, making good, etc., as may be required to accommodate his work due to late or wrong information been given by the Sub-contractor.

Formal shop drawings need not be prepared by the Sub-contractor, but copies of the engineer's drawings shall be marked up by the Sub-contractor and submitted via the contractor to the engineer for approval. These approved marked-up drawings shall be considered to be the working drawings. The engineer's approval of drawings or samples is limited to checking for conformity with design requirements. This shall not relieve the Sub-contractor of responsibility for erecting, installing, fitting or for deviating from the requirements of the

	New Libraries for the Limpopo Department of Sports, Art and Culture (DSAC) Library Name: LDPWRI-PROF/18005	Rev	00
		SQET File	
		ECSA Stage	4
		Discipline	Mechanical

agreement unless the Sub-contractor has informed the engineer in writing of such deviation at the time of submission of drawings or samples, and the engineer has given written approval for the specific deviation. The engineer's approval shall not relieve the Sub-contractor of responsibility for errors or omissions in the drawings or samples.

Any work installed before approval of working drawings may be liable for removal at the engineer's discretion.

The engineer's drawings and specifications shall be considered binding with regard to the quality, quantity, general scheme system, arrangement and function of the works. All dimensions specially marked on the drawings shall be strictly followed.

1.10 CONFIRMATION OF ISSUES

Notwithstanding anything to the contrary as may be set down in the Subcontract Agreement, but rather as an extension to these clauses, it will be in the interest of the Sub-contractor to ensure that any verbal instruction, directive, explanation, etc., given as well as any agreement made or whatever, whether it will involve a variation or not, is confirmed in writing by the Engineer and/or the Principal Contractor within 14 days of it being given or made.

Failure on the side of the Sub-contractor to do so may invalidate any claim for a variation to the works and additional payment.

1.11 OTHER ENGINEERING CONTRACTS

Where water supplies and drainage are requested for air-conditioning plants, water softeners, boilers, calorifiers, hot water tanks, sterilisers and similar equipment provided outside the scope of the plumbing Sub-contractor's work, the extent of the plumbing Sub-contractor's responsibility will be as stated in the Project Specification.

The plumbing Sub-contractor shall, unless otherwise instructed in the Project Specification, terminate his piping with isolating valves in the positions indicated on the drawings.

1.12 NOISE

All water systems, including all mechanical equipment installed in said system, shall be free from objectionable noises, such as water hammer, etc. The Sub-contractor shall in the installation of all materials and equipment, and at commissioning, ensure the above.

Any equipment generating unacceptable noises, in the opinion of the Engineer, shall be corrected or dampened as directed by the Engineer at no additional cost to the subcontract.

1.13 PROTECTION

The Sub-contractor shall protect all work and material, i.e. his and others, from damage by his work and workmen, and shall be liable for all damage caused should the protection not be provided or prove to be inadequate. The Sub-contractor's responsibility in this respect shall extend until his work and equipment have been finally inspected, tested and accepted.

	New Libraries for the Limpopo Department of Sports, Art and Culture (DSAC) Library Name: LDPWRI-PROF/18005	Rev	00
		SQET File	
		ECSA Stage	4
		Discipline	Mechanical

Open ends of pipework shall be closed with temporary covers or plugs during storage and construction to prevent entry of obstructing material. This shall be strictly enforced.

1.14 TESTING AND INSPECTIONS

The plumbing Sub-contractor shall, at his own cost, make all necessary arrangements and provide all necessary facilities for testing and inspection of the installation by the local authorities concerned and other authorised interested parties. The plumbing Sub-contractor shall provide any instruments or equipment required for these tests. The execution of these tests shall be to the complete satisfaction of the inspecting authorities/parties.

1.15 TUITION

The sub-contractor shall provide capable instructor/s to train the client's personnel. The instructor/s shall be available for a total period of 1 (one) working day (eight hours) after the system has been commissioned and handed over to the client. The Operating and Maintenance Manuals shall be in possession of the client before the training commences.

Training provided must include:

1. Information provided in the Design Intent Report (including energy / environmental features)
2. Review of controls set up, programming, alarms and troubleshooting
3. Review of O&M manuals
4. Building operation (start up, normal operation, unoccupied operation, seasonal changeover, shutdown)
5. Measures that can be taken to optimise energy efficiency
6. Occupational Health and Safety (OH&S) issues
7. Maintenance requirements and sourcing replacements; and
8. Obtaining and addressing occupant satisfaction feedback

1.16 GUARANTEE AND MAINTENANCE

The Sub-contractor shall guarantee the works against defects for a period of one (1) year from date of completion.

The guarantee shall cover all defects to the works and shall provide for the replacement or repair of all components that become defective during the guarantee period. Consumable components are excluded from the guarantee.

Where component parts or equipment are supplied by the employer, the contractor or the agent or where the make is specified without an alternative, then the Sub-contractor shall be responsible for such component parts or equipment only to the extent that the Sub-contractor is able to assign to the employer the benefit of warranties by the supplier or manufacturer.

The works is to be operated and maintained in accordance with the Operating and Maintenance Manuals prepared by the Sub-contractor. Any damage to the works resulting from the employer's failure to comply with the procedures set out in these manuals will not be covered by the guarantee.

	New Libraries for the Limpopo Department of Sports, Art and Culture (DSAC) Library Name: LDPWRI-PROF/18005	Rev	00
		SQET File	
		ECSA Stage	4
		Discipline	Mechanical

The sub-contractor shall provide free maintenance for a period of 1 (one) year following the hand over to the client. The maintenance shall include for all management, labour, lubricating materials, cleaning materials and transport.

The guarantee shall be given to the Principle Contractor. Where the guarantee period extends beyond the patent defects liability period of the Principal Building Agreement, the guarantee shall be ceded to the employer for the remainder of the period.

	New Libraries for the Limpopo Department of Sports, Art and Culture (DSAC) Library Name: LDPWRI-PROF/18005	Rev	00
		SQET File	
		ECSA Stage	4
		Discipline	Mechanical

TECHNICAL SPECIFICATIONS

2 WET SERVICES

2.1 PIPING

All piping materials are to as per the table below (unless otherwise noted):

Installation Type	Material
Internal domestic hot and cold water reticulation	Class 2 Copper
Rainwater and sanitary drainage	PVC
Fire services reticulation	Steel Tubing OR Galvanised steel tubing (where allowed by the relevant local authority)

2.2 WATER EFFICIENCY

The following fixtures are to have a maximum water usage rate as per the following table:

Fixture	Water Usage Rate
Water Closet	3.6 L/flush (average of 1 full flush and 4 half flushes)
Indoor taps	6.0 L/minute
Showerhead	9.0 L/minute

At project completion, sub-contractor is to provide confirmation of installation of all hydraulic fixtures and fittings, along with technical data sheets indicating the flush or flow rates of each.

2.3 DOMESTIC WATER INSTALLATION

2.3.1 *Potable Domestic Cold Water Piping*

All piping shall be Serbco PPR piping or similar approved.

The piping shall be **blue** in colour.

All works to be undertaken to the Supplier's Installation Guidelines (available from the suppliers).

2.3.2 *Non-potable Water Piping*

All piping shall be Serbco PPR piping or similar approved.

The piping shall be **green** in colour.

All works to be undertaken to the Supplier's Installation Guidelines (available from the suppliers).

	New Libraries for the Limpopo Department of Sports, Art and Culture (DSAC) Library Name: LDPWRI-PROF/18005	Rev	00
		SQET File	
		ECSA Stage	4
		Discipline	Mechanical

2.3.3 Hot Water Supply and Return Piping

All piping shall be Serbco PPR piping or similar approved.

The piping shall be **red** in colour.

All works to be undertaken to the Supplier's Installation Guidelines (available from the suppliers).

2.4 NON-POTABLE WATER STORAGE SYSTEM

All urinary points and water closets are to be serviced with non-potable water supply circulated from water storage tanks located at the upper basement level. The water storage tanks shall be replenished by supplies from both borehole water and municipal domestic water.

A total of five water storage tanks, each at 5000L in size, shall be required. Refer to the plumbing drawings for the reticulation to and from the water storage tanks including the distribution and positions of the required valves.

All installation works to be undertaken to the water tank Supplier's Installation Guidelines (available from the suppliers).

2.5 SANITARY DRAINAGE INSTALLATION

2.5.1 Sanitary Drainage Piping Above Ground

Soil and waste pipes shall be PVC pipes and fittings. All works to be undertaken to the Supplier's Installation Guidelines (available from the suppliers).

2.5.2 Sanitary Drainage and Waste Piping in Ceiling Voids

Soil and waste pipes shall be PVC pipes and fittings. All works to be undertaken to the Supplier's Installation Guidelines (available from the suppliers).

2.5.3 Sanitary Drainage Piping Under Ground

Soil and waste pipes shall be uPVC pipes and fittings. All works to be undertaken to the Supplier's Installation Guidelines (available from the suppliers).

2.5.4 External Drainage Piping

Soil and waste pipes shall be uPVC pipes and fittings. All works to be undertaken to the Supplier's Installation Guidelines (available from the suppliers).

2.6 WATER METERING STRATEGY

All water meters shall be monitored via a central automated monitoring system to allow for monitoring trends and leak detection. The water meter shall be selected in liaison with the controls sub-contractor to ensure compatibility with the controls backbone.

Refer to the plumbing drawings for more the number and size of water meters required.

	New Libraries for the Limpopo Department of Sports, Art and Culture (DSAC) Library Name: LDPWRI-PROF/18005	Rev	00
		SQET File	
		ECSA Stage	4
		Discipline	Mechanical

	New Libraries for the Limpopo Department of Sports, Art and Culture (DSAC) Library Name: LDPWRI-PROF/18005	Rev	00
		SQET File	
		ECSA Stage	4
		Discipline	Mechanical

2.7 ASSOCIATED ELECTRICAL WORK

All electrical switchgear and wiring required for the proper operation of the works shall be provided by the Sub-contractor.

The Sub-contractor shall liaise with the Principal Contractor and Electrical Sub-contractor and provide all necessary assistance, information (such circuit breaker type and overload protection required), etc., to ensure that the correct power supplies are provided to his equipment. The Sub-contractor shall assure himself that the power supply to his equipment is installed correctly and that, once switched on, it will not damage his equipment.

All costs arising from the failure to comply with the above instructions will be for the Sub-contractor's account.

GENERAL NOTES

- All dimensions are in millimeters unless otherwise stated.
- Dimensions are to be READ and not scaled off from the drawing.
- Contractor(s) are to confirm all dimensions on site prior to commencement of construction and any discrepancies are to be reported to the Mechanical Engineer.

SPECIFIC INSTRUCTIONS

- NOTES:
- DUCTING TO BE MANUFACTURED IN ACCORDANCE TO BRANCO STANDARDS
 - ALL DUCT DIMENSIONS INCLUDING DIMENSIONS FOR INSULATED DUCTS REFERS TO THE SHEET METAL SIZE.
 - ALL DUCT PAGING THROUGH CONCRETE OR BRICK WALLS SHALL BE SEALED FROM THE WALLS BY MEANS OF A HIGH DENSITY GLOSS FIBRE COLLAR OF AT LEAST 25mm IN THICKNESS.
 - GALVANISED STEEL SHALL BE USED FOR ALL AIR-CONDITIONING AND VENTILATION DUCTING.
 - ALL DUCTING SHALL BE PROVIDED WITH WEEZ FLANGES.
 - ALL SUPPLY AND RETURN AIR DUCTING EXPOSED TO OUTDOORS SHALL BE THERMALLY INSULATED, GLASSED AND INSULATED AGAINST DIRECT SOLAR HEAT GAINS.
 - ALL OPEN END DUCTS TO BE CAPPED OFF WITH PLASTIC PRIOR TO OCCUPANCY TO SITE.
 - DUCT HANGERS

DUCT SIZE (mm)	DUCT TYPE	INSULATION THICKNESS (mm)	GLASSING TYPE	INSULATION TYPE
150	Supply	25	None	None
150	Return	25	None	None
200	Supply	25	None	None
200	Return	25	None	None
250	Supply	25	None	None
250	Return	25	None	None
300	Supply	25	None	None
300	Return	25	None	None

- ALL DIFFUSER SUPPLY FLEXIBLE FIT TO COVER IN PANELS, CLAMPS AND SEALED WITH DUCT TAPE ON FINAL INSTALLATION.
- ALL SUPPLY AIR DUCTING TO BE INSULATED THERMALLY WITH 25mm FOR FACED FERRISS ABS TYPE FIB. ONLY AC DUCT.
- ALL FLEXIBLES TO BE THERMALLY INSULATED - ONLY AC DUCT.

LEGEND

- Install Louvered Grille 3000 x 1200mm (L x H)
- WALL MOUNTED THERMOSTAT MOUNTED @ 1400mm A.F.F.L.
- DOOR UNDERCUT - 40mm
- PRESSURE DISPLAY UNIT ABOVE DOOR

EQUIPMENT LEGEND

SYMBOL	No. OFF	DESCRIPTION
2	2	High Wall Split Unit
4	4	Return Air Grille
6	6	Hide-Away Unit
2	2	Outdoor Condenser Unit
8	8	Moisture Changing Unit
3	3	Ceiling Cassette Unit
20a		Condensate Drain Pipe
As Shown		High Pressure Gas Pipe
As Shown		High Pressure Liquid Pipe
2		Extraction Fan

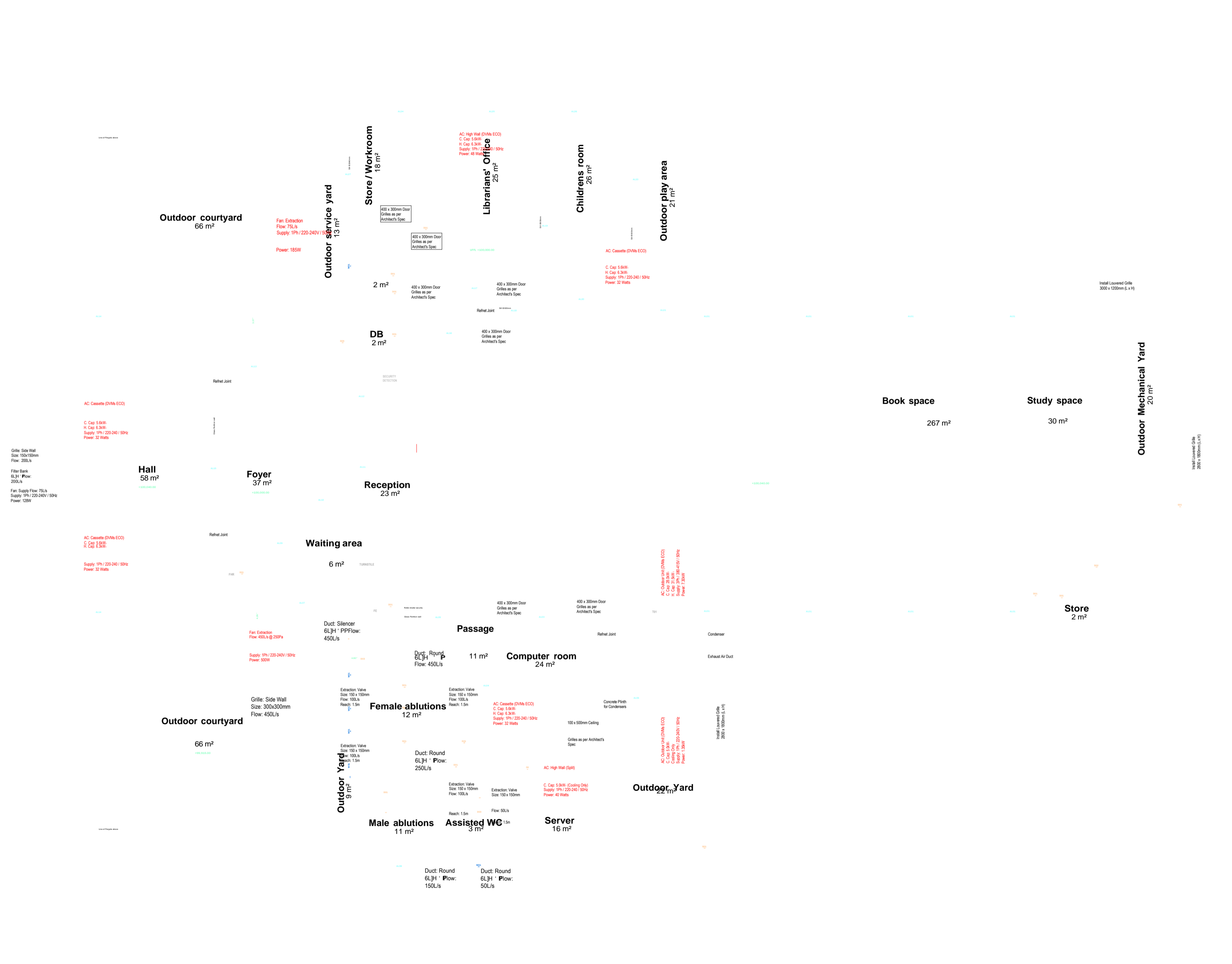

NOTES:
 1. DETAILED DESIGN
 Revision 4: Change of Ceiling Layout
 Revision 3: Change of Architectural Layout
 Revision 2: New HVAC Layot
 Revision 1: New HVAC Layot

LEGEND:

HEATING VENTILATION AND AIR-CONDITIONING
 NEW LIBRARIES FOR THE LIMPOPO DEPARTMENT OF SPORTS, ART AND CULTURE (DSAC)
 LIBRARY NAME:

LDPWI/21-22

LDPWRI-PROF/18005

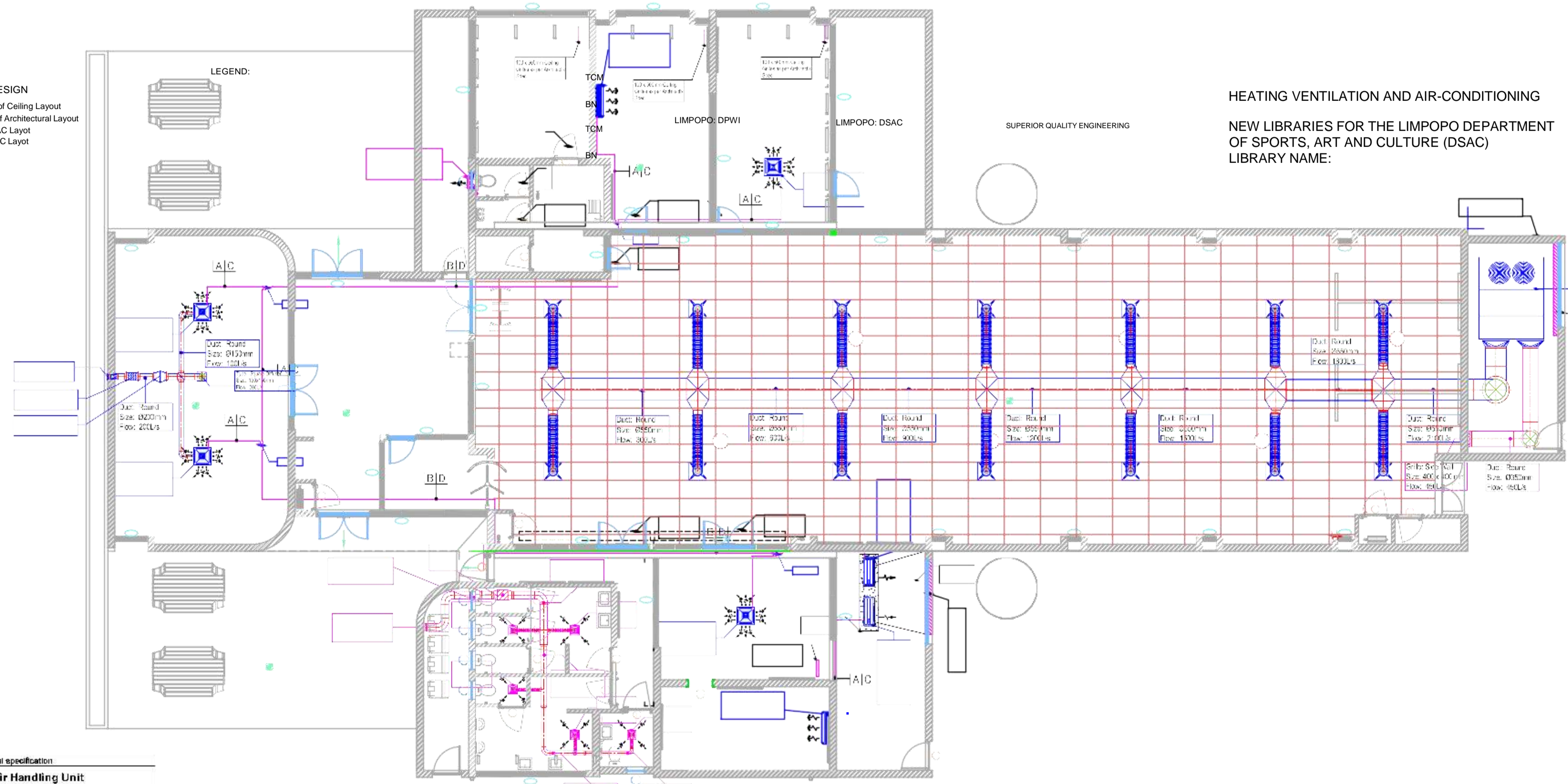

Technical specification

Air Handling Unit		
Parameter(Unit)		
Unit	Model — FOUR53	
Nominal Capacity	Cooling kW Btu/h	53 180000
	Heating kW Btu/h	55 191000
EER/COP		
Sound Pressure Level (HML) f	dB (A)	70.9
Air Flow Volume	CFM	7000
Rated EDP	Pa	90
Power supply	V Hz Ph	380-415-30-3
Power Input	Cooling	18.7
	Heating	17.2
MECA		A
Refrigerant	Refrigerant Type	R410A
	Throttling Method	Throttle
Evaporator Fan motor	Charge	kg 61 ± 0.3
	Diameter	inch
Compressor	Motor Drive Type	—
	Type	Fixed Screw
Condenser Fan motor	Quantity	2
	Quantity	1
Drainage Connection Size	mm	25
Operating Range	Cooling	5-24
	Heating	5-24

Main Hall							
Schedule of Air Supply Ducting							
Node	Diffusers	Hum Flow	Velocity	Duct Diameter	Pipe Length	Friction Losses	Total Losses
No	L/s	m³/s	m/s	mm	m	Pa/m	Pa
A3	14	2100	7.10	900	4.5	1.50	14.75
BC	12	1800	6.80	750	4.5	1.22	5.05
C1	10	1500	6.00	600	4.5	0.75	3.57
DE	8	1200	5.20	550	4.5	0.52	2.34
EF	6	900	4.50	550	4.5	0.30	1.35
FG	4	600	3.00	550	4.5	0.4	0.63
GI	2	300	1.25	550	4.5	0.04	0.17
Return	1	150	0.75	400	8	0.40	3.19
Total Losses							30.58

Ablation Facility							
Schedule of Air Extraction Ducting							
Node	Diffusers	Volume Flow	Velocity	Duct Diameter	Pipe Length	Friction Losses	Total Losses
No	L/s	m³/s	m/s	mm	m	Pa/m	Pa
VW	5	450	0.45	30.00	250	5	4.22
WX	3	250	0.25	30.00	200	3	4.23
XY	2	150	0.15	10.00	1.00	4	0.60
VZ	1	50	0.05	30.00	100	2	5.45
Branch	5	100	0.1	30.00	100	5	21.08
Total Losses							194.24

REVISION	NO	DESCRIPTION

DESIGNED BY	
CHECKED BY	
DRAWN BY	
APPROVED BY	

CLIENT:

 PUBLIC WORKS, ROADS & INFRASTRUCTURE
 43 CHURCH STREET
 POLDORIANE
 0700
 TEL : 015 - 284 7000
 FAX :

CLIENT:

 PUBLIC WORKS, ROADS & INFRASTRUCTURE
 43 BECARD STREET
 POLDORIANE
 0700
 TEL : 054 84 4000
 FAX :

CONSULTANT:

 62 WOLFE STREET
 POLDORIANE
 0700
 TEL : 015 - 284 5700
 FAX : 006 514 0512
 e-MAIL : admin@superiorengineers.com

DRAWING TITLE	HEATING VENTILATION AND AIR-CONDITIONING
PROJECT TITLE	NEW LIBRARIES FOR THE LIMPOPO DEPARTMENT OF SPORTS, ART AND CULTURE (DSAC)

DRAWING NUMBER	LDPWRI-PROF/18005	PAPER SIZE	A1
PROJECT NUMBER		SCALE	1:75
CONTRACT No			



FIRE PROTECTION AND DETECTION LEGEND		
SYMBOL	DESCRIPTION	QUANTITY
	ESCAPE ROUTES	0
	2 HR FIRE RATED WALL (INTEGRITY/INSULATION/STABILITY)	0
	1 HR FIRE RATED WALL (INTEGRITY/INSULATION/STABILITY)	0
	30min FIRE RATED WALL (INTEGRITY/INSULATION/STABILITY)	0
	4 min FIRE RATED WALL (INTEGRITY/INSULATION/STABILITY)	0
	CLASS W FIRE DOOR - 120min FIRE RATINGS WITH DOOR CLOSERS	0
	CLASS Y FIRE DOOR - 60min FIRE RATINGS WITH DOOR CLOSERS	0
	CLASS D FIRE DOOR - 240min FIRE RATINGS WITH DOOR CLOSERS	0
	30m FIRE HOSE REEL	0
	FIRE HOSE REEL PATH	0
	TOTAL ESCAPE DISTANCE	0
	COMMON PATH OF TRAVEL	0
	1kg DRY CHEMICAL POWDER FIRE EXTINGUISHER	0
	4.5kg DRY CHEMICAL POWDER FIRE EXTINGUISHER	0
	1kg CO FIRE EXTINGUISHER	0
	10kg INSTANTANEOUS FIRE HYDRANT	0
	FIRE DEPARTMENT BOOSTER PUMP	0
	WHEEL CHAIR REFUGE ZONE (1400mmx900mm) WITH FIRE PHONE	0
	MANUAL CALL POINT	5
	DRY CHEMICAL POWDER	0
	FIRE BLANKET	0
	CEILING MOUNTED SMOKE DETECTOR	14
	FIRE CONTROL PANEL	1
	GAS FIRE SUPPRESSION SYSTEMS	0
	SOUNDER BEACON	2

GENERAL NOTES

- All dimensions are in millimeters unless otherwise stated.
- Dimensions are to be READ and not scaled off from the drawing.
- Contractor(s) are to confirm all dimensions on site prior to commencement of construction and any discrepancies are to be reported to the Project Architect.

FIRE PROTECTION NOTES

ALL FIRE PROTECTION INSTALLATION AND SIGNAGE WILL BE IN ACCORDANCE TO SANS 10400 PART 1, W AND A.

ALL FIRE DETECTION AND ALARM SYSTEMS FOR BUILDINGS WILL IN ACCORDANCE TO SANS 10139

1. ALL WORK TO COMPLY WITH LOCAL FIRE DEPARTMENT REQUIREMENTS & SANS 10400 PART -T 2011 .

2. ALL WORK TO COMPLY WITH ACT 103 OF 1977 AND SANS 10400 PART -T 2011.

3. ALL WORK TO COMPLY WITH LOCAL FIRE DEPARTMENT REQUIREMENTS AND: - SANS 10252 PART 1: WATER RETICULATION DESIGN

- FIRE EQUIPMENT IN ACCORDANCE WITH SANS 10400 PART -T 2011
- FIRE HOSE REELS PROVIDED AS PER SANS 10400 PART -T 2011
- FIRE HYDRANT PROVIDED AS PER SANS 10400 PART -T 2011
- PORTABLE FIRE EXTINGUISHERS TO BE INSTALLED IN ACCORDANCE WITH SANS 10105, HOSE REELS TO BE INSTALLED IN ACCORDANCE WITH SANS 10543, HYDRANTS TO BE INSTALLED IN ACCORDANCE WITH SANS 1128.
- PORTABLE FIRE EXTINGUISHERS PROVIDED AS PER SANS 10400 PART -T 2011
- EXTINGUISHERS TO BE INSTALLED IN ACCORDANCE WITH SANS 10105
- PORTABLE FIRE EXTINGUISHERS TO BE HUNG ON PURPOSE MADE BOARDS, AS INDICATED ON PLAN.
- SUSPENDED CEILING & ITS SUPPORTING MEMBERS TO BE NON-COMBUSTIBLE.

12. NO COMBUSTIBLE CEILING WILL BE ALLOWED EXCEPT IF A CEILING IS TESTED IN ACCORDANCE TO SANS 10177-5 AND IF IT IS USED IN ACCORDANCE WITH SANS 428.

13. FIRE WALLS WILL EXTEND TO THE UNDERSIDE OF THE ROOF COVERING

AND NO COMBUSTIBLE ROOF ELEMENT WILL PENETRATE SUCH WALL.

14. ACCESS DOORS & ESCAPE DOORS IN ANY EMERGENCY ROUTE MAY

ONLY BE FITTED WITH LOCKING DEVICES AS APPROVED BY THE LOCAL AUTHORITY.

- 'B' CLASS FIRE DOORS 900MM WIDE TO COMPLY WITH SANS 1253 & TO BE FITTED WITH APPROVED SELF CLOSING DEVICES.
- THE EXIT WIDTH OF A DOOR SHALL BE NOT LESS THAN 750MM.
- WIDTH OF ESCAPE ROUTES SHALL BE MAINTAINED AT 1.5M AND SANS

10400 PART -T 2011 .

18. MARKING AND SIGNAGE TO COMPLY WITH SABS 1186. PICTORIAL SIGNS INDICATING FIRE EQUIPMENT AND MEANS OF ESCAPE TO BE PROVIDED

AND TO COMPLY WITH TTS2.2, TTS5.4. ALL SIGNAGE WILL BE PHOTO LUMINESCENT AND SUPPORTED WITHOUT THE USE OF ADHESIVE OR COMBUSTIBLE MATERIALS.

- PHOTO LUMINESCENT ESCAPE SIGNS TO BE PROVIDED AND TO COMPLY WITH SANS 1186 PART 1 AND 5, AS PER 4.29
- WALL COVERINGS TO COMPLY WITH SANS 10400 PART TT 4.15.
- STRUCTURAL ELEMENTS AND COMPONENTS TO COMPLY WITH TT4.7.
- WATER SUPPLY TO THE FIRE FIGHTING EQUIPMENT TO COMPLY WITH SANS 10400-2011 PART W AND WITH JHB WATER BY LAWS.
- ALL PIPE WORK TO COMPLY WITH SANS 62 PART 1.
- ALL EXPOSED FIRE PIPES TO BE PAINTED RED

FIRE PROTECTION DESIGN

Total Stand Area: Vaires

Total Built Area: 650m²

Building Classification: A3 - Place of Instruction

Hydrant Requirements: 1 per 1000m²

Hose Reel Requirements: 1 per 250m²

Maximum Hose Length: 30m

Fire Detection Category: L1

Operating Parameters

- Up to three (2) Fire Hose Reels operating simultaneously
- Flow rate: 0.5L/s per Fire Hose Reel
- Pressure: 300kPa (at outlet of each Hose Reel)
- Fire Water for upto 2 hours of operation
- Source: Back-Up Fire Water (10.8 kL)

LDPWI/21-22
LDPWRI-PROF/18005

FIRE DETECTION SYSTEM
NEW LIBRARIES FOR THE LIMPOPO DEPARTMENT OF SPORTS, ART AND CULTURE (DSAC)
LIBRARY NAME:

NOTES:
1. DETAILED DESIGN

Revision 1: Change of Architectural Layout

LEGEND:
TCM
BN
TCM
LIMPOPO: DPWI
LIMPOPO: DSAC
SUPERIOR QUALITY ENGINEERING



REVISION

DESIGNED BY	
CHECKED BY	
DRAWN BY	
APPROVED BY	

CLIENT	
--------	--

43 CHURCH STREET
POLOKwane
0700
TEL: +27 15 - 284 7000
FAX: +27 15 - 284 7000

43 BICARD STREET
POLOKwane
0700
TEL: +27 15 - 284 4000
FAX: +27 15 - 284 4000

101 MOSELEY STREET
POLOKwane
TEL: 015 - 290 5100
FAX: +27 15 4 8113
e-MAIL: admin@superiorengineers.com

DRAWING NUMBER:	LDPW-01-MEC002
PROJECT NUMBER:	
CONTRACT No:	
DRAWING TITLE:	
PROJECT TITLE:	

PAPER SIZE:	A1
SCALE:	1:75

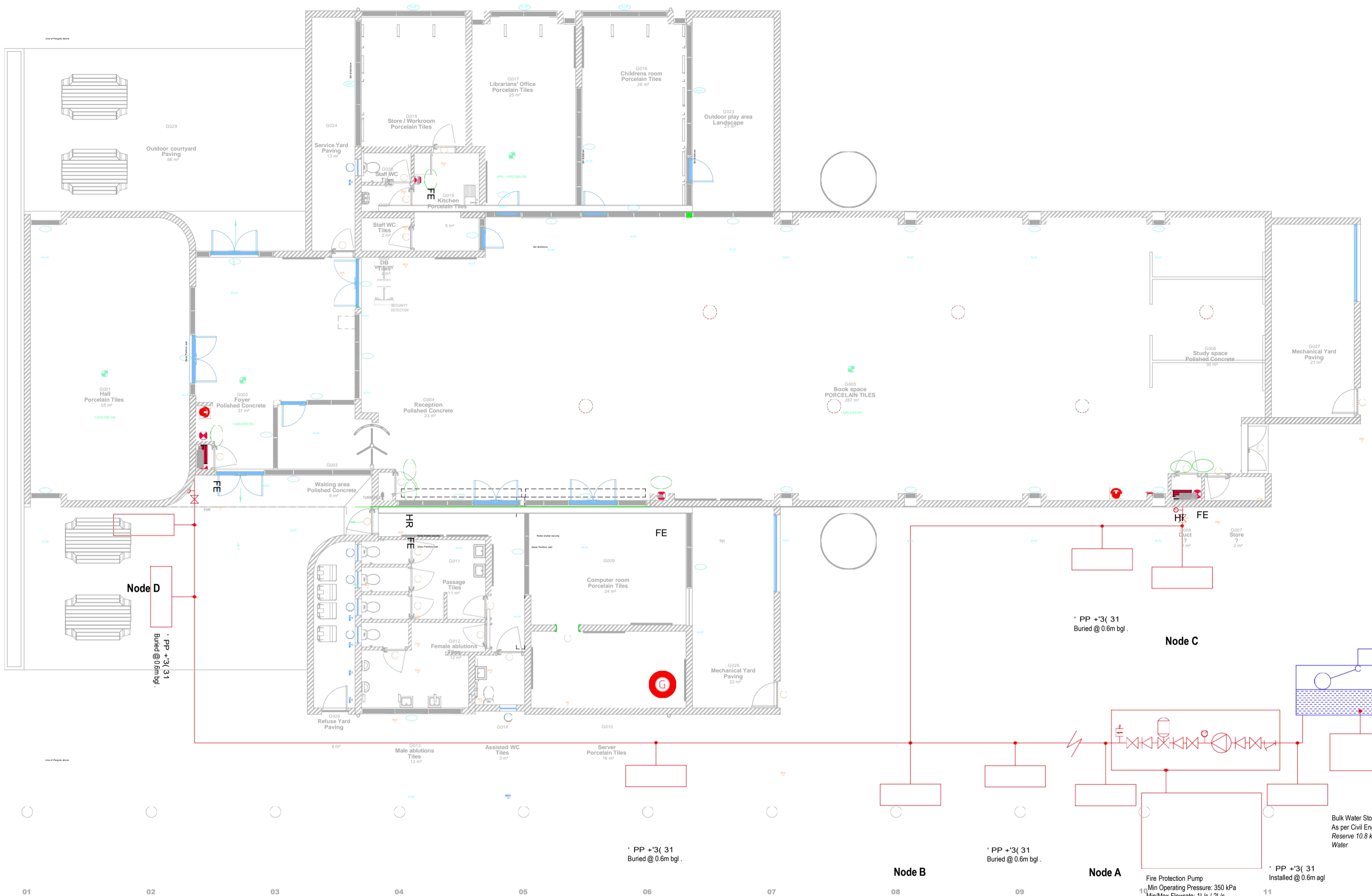

FIRE PROTECTION AND DETECTION LEGEND		
SYMBOL	DESCRIPTION	QUANTITY
—	ESCAPE ROUTES	0
—	2 HR FIRE RATED WALL (INTEGRITY/INSULATION/STABILITY)	0
—	1 HR FIRE RATED WALL (INTEGRITY/INSULATION/STABILITY)	0
—	30 MIN FIRE RATED WALL (INTEGRITY/INSULATION/STABILITY)	0
—	4 HR FIRE RATED WALL (INTEGRITY/INSULATION/STABILITY)	0
—	CLASS 9 FIRE DOOR - 120MIN FIRE RATING WITH DOOR CLOSERS	0
—	CLASS 8 FIRE DOOR - 90MIN FIRE RATING WITH DOOR CLOSERS	0
—	CLASS 7 FIRE DOOR - 60MIN FIRE RATING WITH DOOR CLOSERS	0
—	CLASS 6 FIRE DOOR - 30MIN FIRE RATING WITH DOOR CLOSERS	0
—	30M FIRE HOSE REEL	3
—	FIRE HOSE REEL PATH	0
—	TOTAL ESCAPE DISTANCE	0
—	COMMON PART OF TRAVEL	0
—	1kg DRY CHEMICAL POWDER FIRE EXTINGUISHER	6
—	4kg DRY CHEMICAL POWDER FIRE EXTINGUISHER	0
—	9kg CO ₂ FIRE EXTINGUISHER	0
—	180 INSTANTANEOUS FIRE HYDRANT	0
—	FIRE DEPARTMENT BOOSTER POINT	0
—	WHEEL CHAIR REFUGE ZONE (1400mmx900mm) WITH FIRE PHONE	0
—	MANUAL CALL POINT	0
—	FIRE BLANKET	2
—	CEILING MOUNTED SMOKE DETECTOR	0
—	FIRE CONTROL PANEL	0
—	GAS FIRE SUPPRESSION SYSTEMS	1
—	SOUNDER BEACON	0

GENERAL NOTES

- All dimensions are in millimeters unless otherwise stated.
- Dimensions are to be READ and not scaled off from the drawing.
- Contractors are to confirm all dimensions on site prior to commencement of construction and any discrepancies are to be reported to the Project Architect.

FIRE PROTECTION NOTES

ALL FIRE PROTECTION INSTALLATION AND SIGNAGE WILL BE IN ACCORDANCE TO SANS 10400 PART T, W AND A.

ALL FIRE DETECTION AND ALARM SYSTEMS FOR BUILDINGS WILL IN ACCORDANCE TO SANS 10139

- ALL WORK TO COMPLY WITH LOCAL FIRE DEPARTMENT REQUIREMENTS & SANS 10400 PART - T 2011.
- ALL WORK TO COMPLY WITH ACT 103 OF 1977 AND SANS 10400 PART - T 2011.
- ALL WORK TO COMPLY WITH LOCAL FIRE DEPARTMENT REQUIREMENTS AND - SANS 10252 PART 1: WATER RETICULATION DESIGN
- FIRE EQUIPMENT IN ACCORDANCE WITH SANS 10400 PART - T 2011
- FIRE HOSE REELS PROVIDED AS PER SANS 10400 PART - T 2011
- FIRE HYDRANT PROVIDED AS SANS 10400 PART - T 2011
- PORTABLE FIRE EXTINGUISHERS TO BE INSTALLED IN ACCORDANCE WITH SANS 10105. HOSE REELS TO BE INSTALLED IN ACCORDANCE WITH SANS 10543. HYDRANTS TO BE INSTALLED IN ACCORDANCE WITH SANS 1128.
- PORTABLE FIRE EXTINGUISHERS PROVIDED AS PER SANS 10400 PART - T 2011
- EXTINGUISHERS TO BE INSTALLED IN ACCORDANCE WITH SANS 10105
- PORTABLE FIRE EXTINGUISHERS TO BE HUNG ON PURPOSE MADE

- BOARDS, AS INDICATED ON PLAN.
- SUSPENDED CEILING & ITS SUPPORTING MEMBERS TO BE NON-COMBUSTIBLE.
 - NO COMBUSTIBLE CEILING WILL BE ALLOWED EXCEPT IF A CEILING IS TESTED IN ACCORDANCE TO SANS 10177-5 AND IF IT IS USED IN ACCORDANCE WITH SANS 428.
 - FIRE WALLS WILL EXTEND TO THE UNDERSIDE OF THE ROOF COVERING AND NO COMBUSTIBLE ROOF ELEMENT WILL PENETRATE SUCH WALL.
 - ACCESS DOORS & ESCAPE DOORS IN ANY EMERGENCY ROUTE MAY ONLY BE FITTED WITH LOCKING DEVICES AS APPROVED BY THE LOCAL AUTHORITY.
 - "B" CLASS FIRE DOORS 900MM WIDE TO COMPLY WITH SANS 1253 & TO BE FITTED WITH APPROVED SELF CLOSING DEVICES.
 - THE EXIT WIDTH OF A DOOR SHALL BE NOT LESS THAN 750MM.
 - WIDTH OF ESCAPE ROUTES SHALL BE MAINTAINED AT 1.5M AND SANS 10400 PART - T 2011.
 - MARKING AND SIGNAGE TO COMPLY WITH SABS 1186. PICTORIAL SIGNS INDICATING FIRE EQUIPMENT AND MEANS OF ESCAPE TO BE PROVIDED AND TO COMPLY WITH TT32.2, TT55.4. ALL SIGNAGE WILL BE PHOTO-LUMINESCENT AND SUPPORTED WITHOUT THE USE OF ADHESIVE OR COMBUSTIBLE MATERIALS.
 - PHOTO-LUMINESCENT ESCAPE SIGNS TO BE PROVIDED AND TO COMPLY WITH SANS 1186 PART 1 AND 5, AS PER 4.2b.
 - WALL COVERINGS TO COMPLY WITH SANS 10400 PART T 4.15.
 - STRUCTURAL ELEMENTS AND COMPONENTS TO COMPLY WITH TT4.7.
 - WATER SUPPLY TO THE FIRE FIGHTING EQUIPMENT TO COMPLY WITH SANS 10400-2011 PART W AND WITH JHB WATER BY-LAWS.
 - ALL PIPE WORK TO COMPLY WITH SANS 62 PART 1.
 - ALL EXPOSED FIRE PIPES TO BE PAINTED RED

FIRE PROTECTION DESIGN

Total Stand Area: Vaies
 Total Built Area: 750m²
 Building Classification: A3 - Place of Instruction
 Hydrant Requirements: Not Required (Built Area < 1000m²)
 Hose Reel Requirements: 3 FHR @ 1 per 250m²
 Maximum Hose Length: 30m
 Fire Detection Category: L1

Operating Parameters

- Up to three (3) Fire Hose Rees operating simultaneously
- Flow rate: 0.5L/s per Fire Hose Reel
- Pressure: 300kPa (at outlet of each Hose Reel)
- Fire Water for upto 2 hours of operation
- Source: Back-Up Fire Water = 3FHR x 0.5L/s x 7200s = 10.8 kL

Dynamic Head Loss										
Node	Pipe Length m	Pipe Diameter Ømm	Pipe Area m ²	Velocity m/s	Flowrate L/s	m ³ /s	m ³ /hr	Friction Losses m		
AB	50	50	1.96E-03	0.76	1.5	1.50E-03	5.4	0.59		
BC	20	50	1.96E-03	0.51	1	1.00E-03	3.6	0.11		
BD	35	32	8.05E-04	0.62	0.5	5.00E-04	1.8	0.43		
Total Dynamic Head Losses								1.13		

Operating Pressure (OP) required at outlet of each Hose Reel is 30m (300kPa)
 Static Head (SH) Losses (due to elevation differences) is 2m (20kPa)
 Dynamic Head (DH) Losses within pipe line 1.35m (13.5kPa)
Total Head Pump = 2 OP, SH, DH = 333.5kPa

Moody's Friction Factor	0.02
-------------------------	------

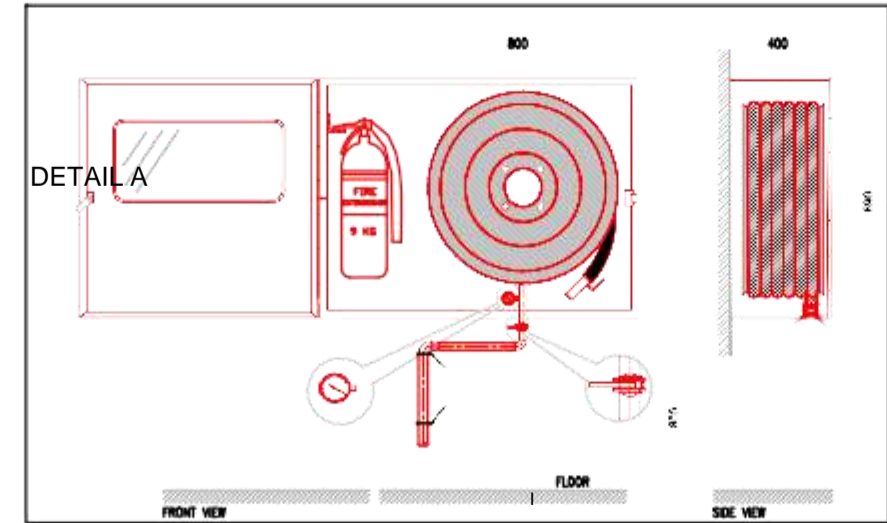

SCHEDULE OF FITTINGS			
Ref	Nominal Diameter [mm]	Description	Installation
A	50 x 50 x 25	Ph 16 HDPE T Fleece	Buried Below Ground Level
B	42	PP 11 - HDPE Pipe	Horizontal Below Ground Level
C	32	Galvanized Steel 90° Bend	Buried Below Ground Level
D	32	Galvanized Steel Pipe	Through Concrete / Above Ground Level
E	25	Galvanized Steel Pipe	Above Ground Level
F	25	Galvanized Steel Pipe	Above Ground Level
G	25	Galvanized Steel Pipe	Above Ground Level
H	25	Galvanized Steel Pipe	Above Ground Level
I	25	Pressure Gauge	Above Ground Level

Fire Protection Pump
 Min Operating Pressure: 350 kPa
 Min/Max Flowrate: 1L/s / 2L/s
 Power Consumption: 5.5kW @ 5.55Amps
 Power Supply: 3 Ph / 380-415V / 50Hz
 Power Connection: From Site Kiosk and Backup Power
 Controller: Automatic Pressure Switch

NOTES: 1. DETAILED DESIGN	DESIGNED BY: K CHECKED BY: K DRAWN BY: APPROVED BY:	 43 CHURCH STREET POLKOWANE 0700 TEL: 015 - 284 7000 ARCHITECTURE Architectural Layout	 43 BICCARD STREET POLKOWANE 0700 TEL: 015 - 284 4000 ARCHITECTURE Architectural Layout	 801 MOUNTAIN VIEW POLKOWANE 0700 TEL: 015 - 284 5000 ARCHITECTURE Architectural Layout	DRAWING TITLE: PROJECT TITLE: BN TCM	DRAWING NUMBER: LDPW/11/202003 PROJECT NUMBER: CONTRACT No: BN	PAPER SIZE: A1 SCALE: 1:75
					REVISION 1. DETAILED DESIGN		

LIMPOPO: DPWI

LIMPOPO:
DSAC

SUPE
RIOR
QUAL
ITY
ENGI
NEER
ING

FIRE
PROTECTI
ON
SYSTEM

LDPWI /21-22

LDPWRI-
PROF/18005

NEW
LIBRARIE
S FOR
THE
LIMPOPO
DEPARTM
ENTOF
SPORTS,
ART AND
CULTURE
(DSAC)
LIBRARY
NAME:



DETAILS

NOTES:
 1. DETAILED DESIGN
 Revision 1: Change of Architectural Layout

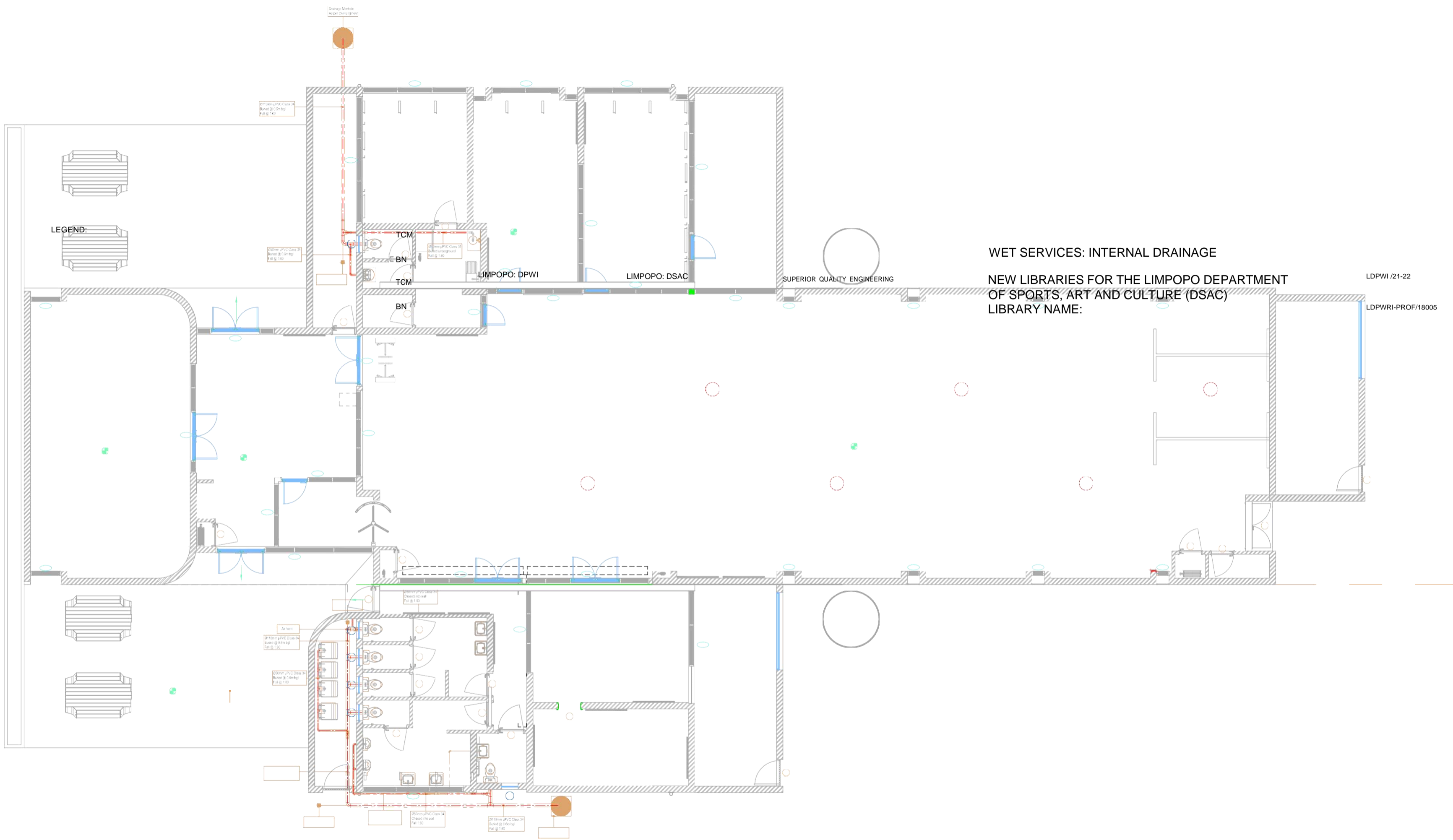

WET SERVICES: INTERNAL DRAINAGE
 NEW LIBRARIES FOR THE LIMPOPO DEPARTMENT
 OF SPORTS, ART AND CULTURE (DSAC)
 LIBRARY NAME:

LDPWI /21-22
 LDPWRI-PROF/18005

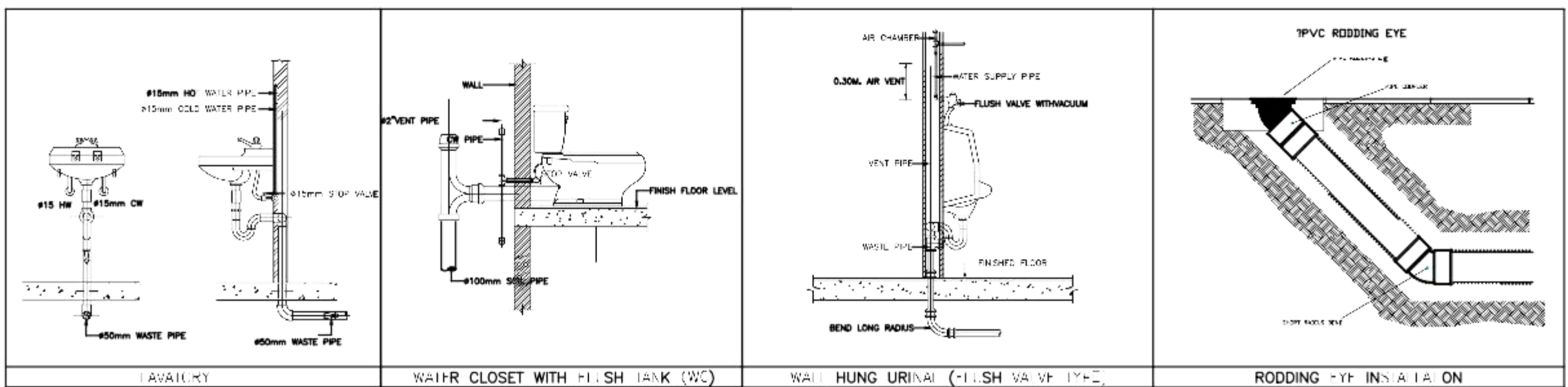

REVISION

DESIGNED BY	
CHECKED BY	
DRAWN BY	
APPROVED BY	

CLIENT:	LIMPOPO PUBLIC WORKS, ROADS & INFRASTRUCTURE
43 CHURCH STREET POLOKWANE 0700 TEL: + 015 - 284 7000 FAX: +	43 BICARD STREET POLOKWANE 0700 TEL: + 0660 4000 FAX: +

CONSULTANT:	SUPERIOR SUPERIOR QUALITY ENGINEERING
94 WINDMILL 2nd FLOOR POLOKWANE 0700 TEL: + 015 - 292 2000 FAX: + 015 292 2000 e-MAIL: + scm@superior-engineers.com	

DRAWING TITLE:	
PROJECT TITLE:	

DRAWING NUMBER:	LDPWI/21-22
PROJECT NUMBER:	
CONTRACT No:	

PAPER SIZE:	A1
SCALE:	1:75

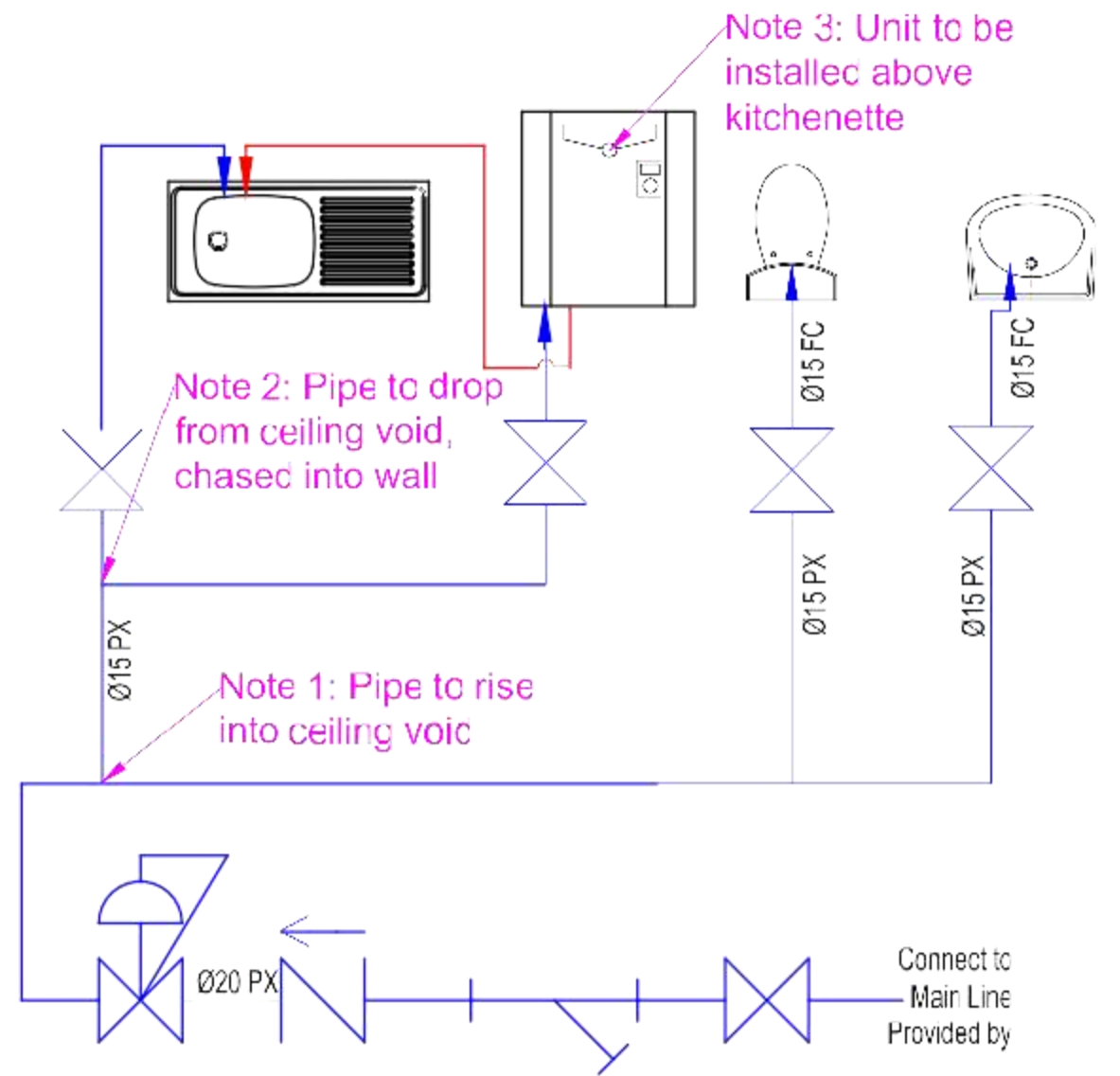
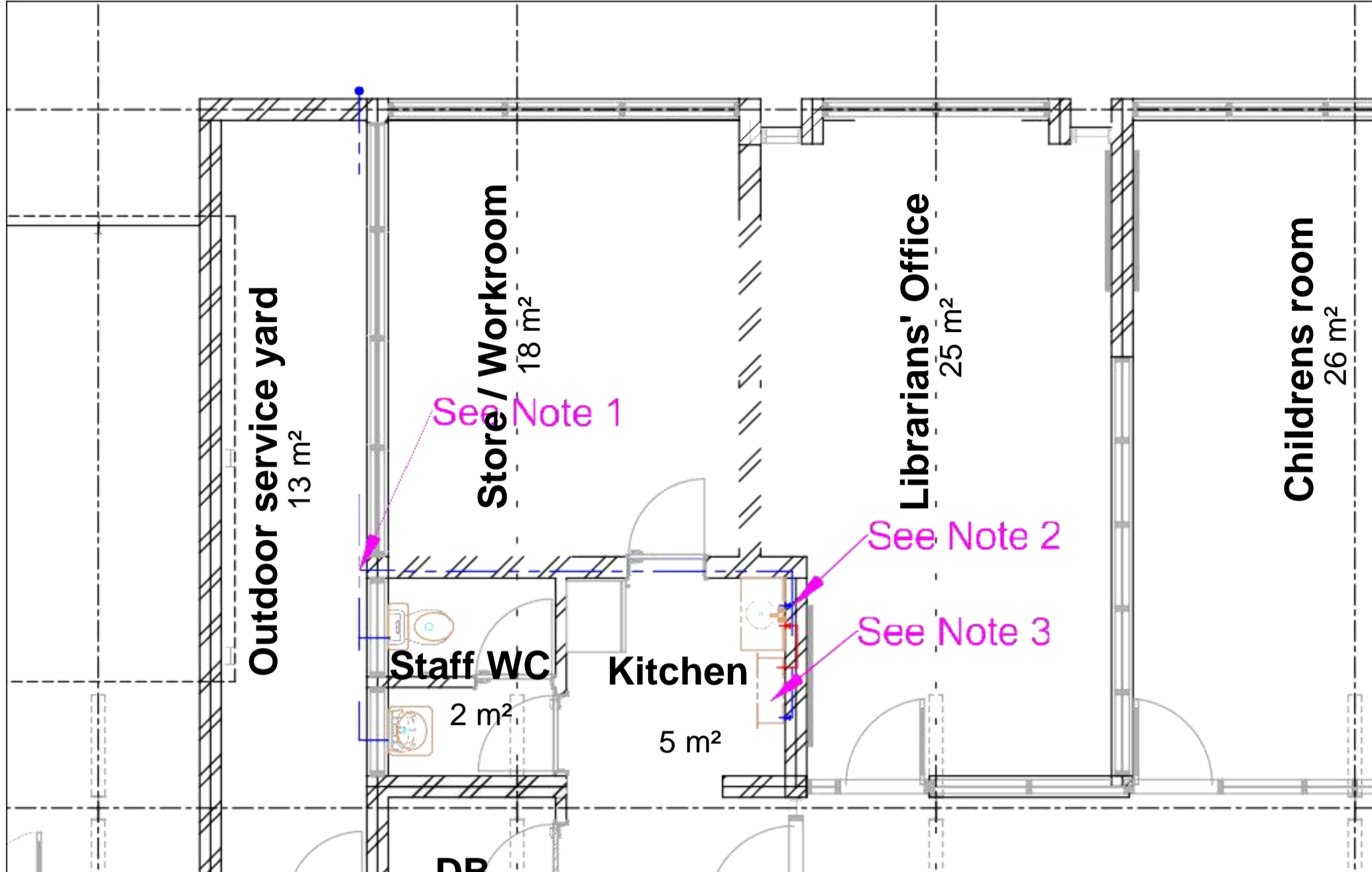

Item No	Description	Symbol
1	Gate Valve	
2	Pressure Regulator	
3	One Way Valve	
4	Smart Metre	
5	Strainer	
6	Cold Water Line	
7	Hot Water Line	

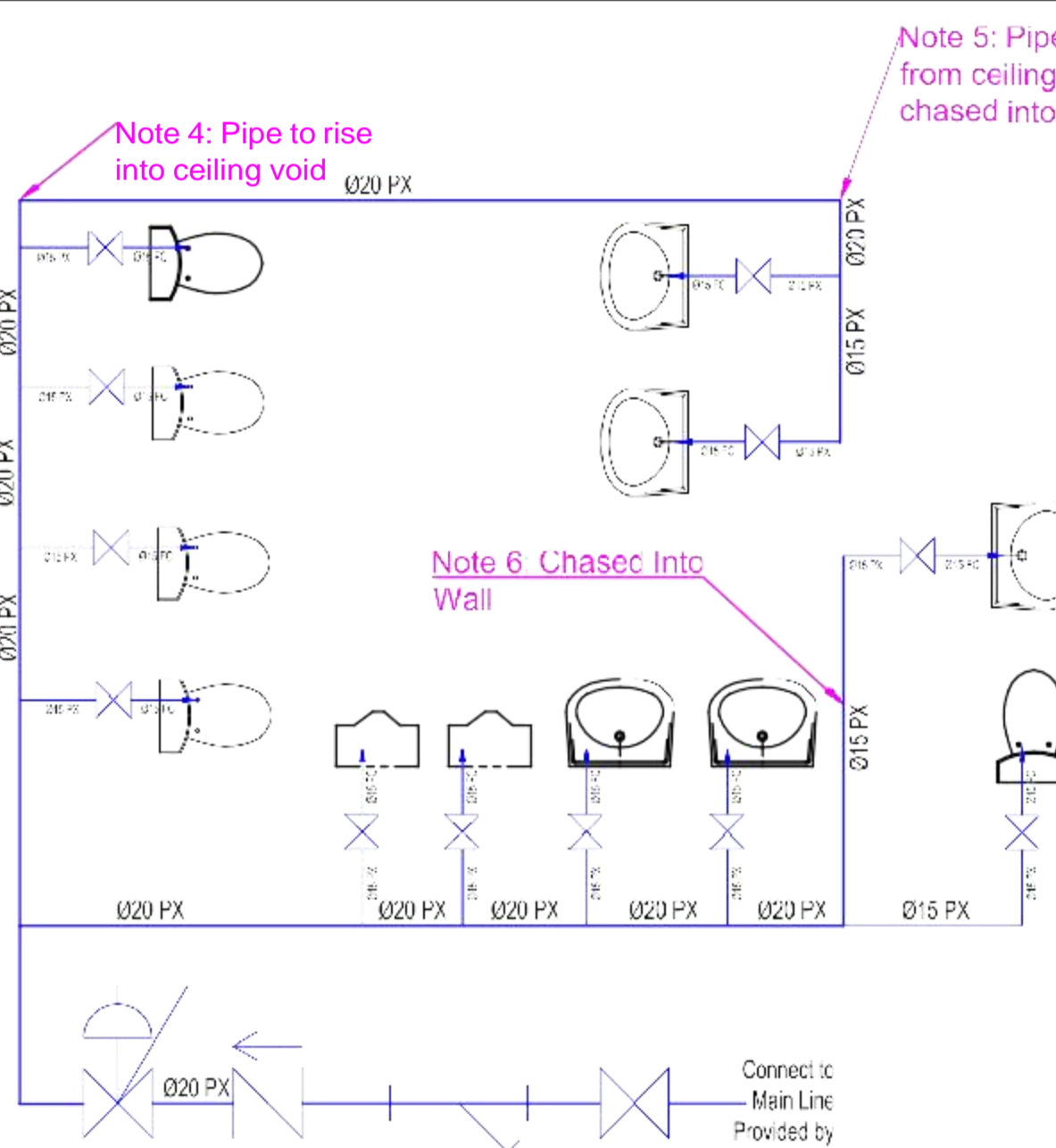
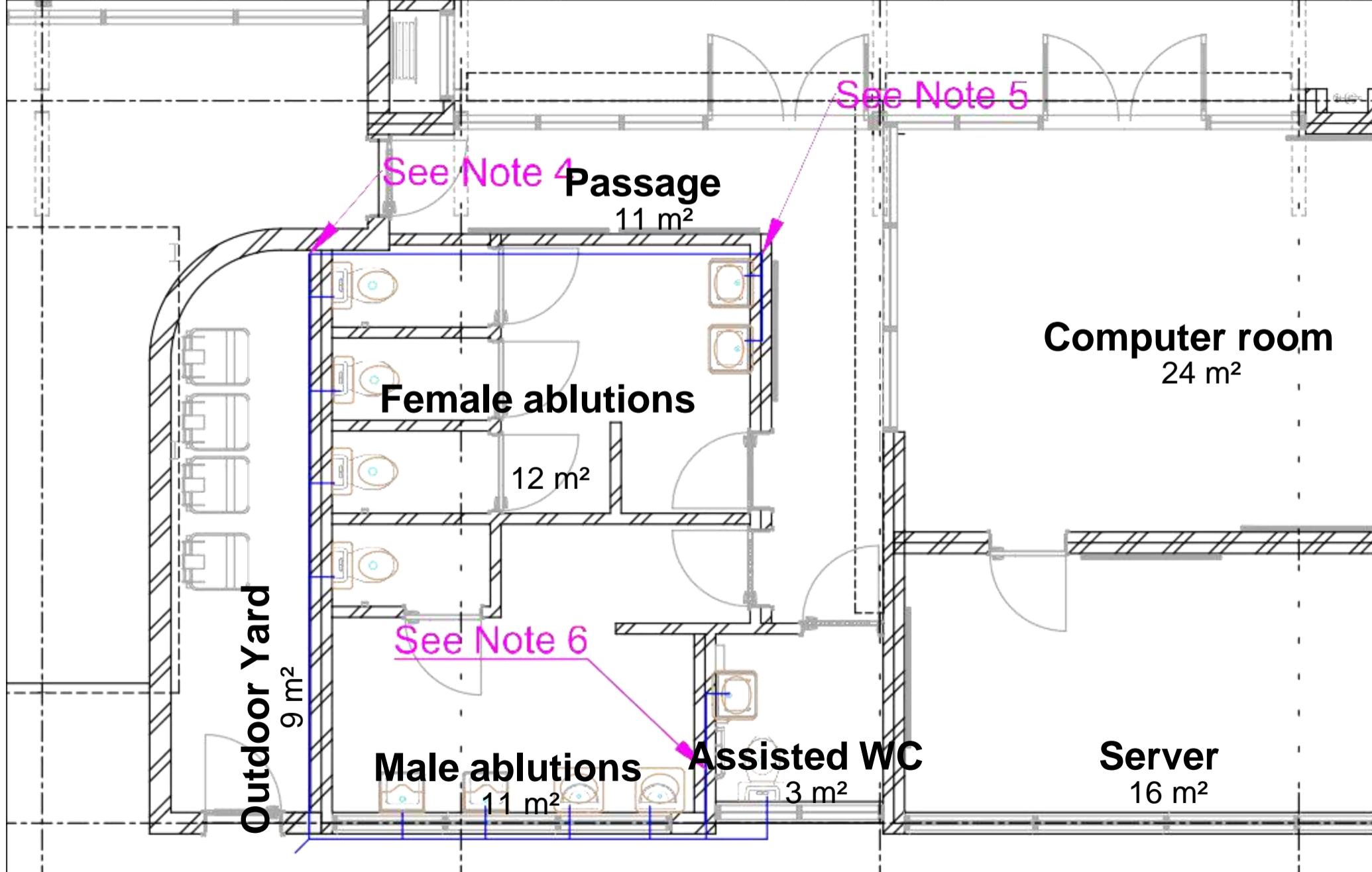

Item No	Description	Symbol
1	Gate Valve	
2	Pressure Regulator	
3	One Way Valve	
4	Smart Metre	
5	Strainer	
6	Cold Water Line	
7	Hot Water Line	

NOTES:	REVISION
1. DETAILED DESIGN	

DESIGNED BY	
CHECKED BY	
DRAWN BY	
APPROVED BY	TCM

CLIENT:	LIMPOPO PUBLIC WORKS, ROADS & INFRASTRUCTURE
ADDRESS:	43 CHURCH STREET POLOKWANE 0700 TEL: 018 284 7000 FAX: 018 284 7000

CLIENT:	LIMPOPO PUBLIC WORKS, ROADS & INFRASTRUCTURE
ADDRESS:	43 BECCARD STREET POLOKWANE 0700 TEL: 018 284 4000 FAX: 018 284 4000

CONSULTANT:	SUPERIOR PUBLIC WORKS, ROADS & INFRASTRUCTURE
ADDRESS:	82 MIDLAND STREET POLOKWANE 0700 TEL: 018 284 4000 FAX: 018 284 4000

DRAWING TITLE:	
PROJECT TITLE:	

DRAWING NUMBER:	LIMPOPO: DSAC001
PROJECT NUMBER:	
CONTRACT No:	LIMPOPO: DSAC

PAPER SIZE:	A1
SCALE:	NA

WATER
SUPPLY

LDP
WI
/21-
22

NEW
LIBRARIES
FOR
THE
LIMPOPO
DEPARTMENT
OF
SPORTS,
ART
AND
CULTURE
(DSC)
LIBRARY
NAME
:

LDP
WRI-
PRO
F/180
05

NOTES:
1. DETAILED DESIGN

LEGEND:

TCM
BN
TCM
BN

LIMPOPO: DPWI

LIMPOPO: DSAC

SUPERIOR QUALITY ENGINEERING

FIRE ESCAPE PLAN AND SIGNAGE

NEW LIBRARIES FOR THE LIMPOPO DEPARTMENT
OF SPORTS, ART AND CULTURE (DSAC)
LIBRARY NAME:

LDPWI /21-22
LDPWRI-PROF/18005



REVISION

DESIGNED BY	
CHECKED BY	
DRAWN BY	
APPROVED BY	

CLIENT	<p>LIMPOPO PUBLIC WORKS, ROADS & INFRASTRUCTURE</p>
	<p>43 CHURCH STREET POLOKwane 0700 TEL: +27 15 - 284 7000 FAX: +27 15 - 284 7000</p>

CLIENT	<p>LIMPOPO PUBLIC WORKS, ROADS & INFRASTRUCTURE</p>
	<p>43 BICARD STREET POLOKwane 0700 TEL: +27 15 - 284 7000 FAX: +27 15 - 284 7000</p>

CONSULTANT	<p>SUPERIOR QUALITY ENGINEERING</p>
	<p>64 MOOREHEAD STREET POLOKwane TEL: 015 - 290 5100 FAX: +27 15 284 7000 e-MAIL: info@superiorengineers.com</p>

DRAWING NUMBER	LDPW-01-MEC003
PROJECT NUMBER	
CONTRACT No	

DRAWING TITLE	
PROJECT TITLE	

PAPER SIZE	A1
SCALE	1:75

Plan View - AHU Plantroom

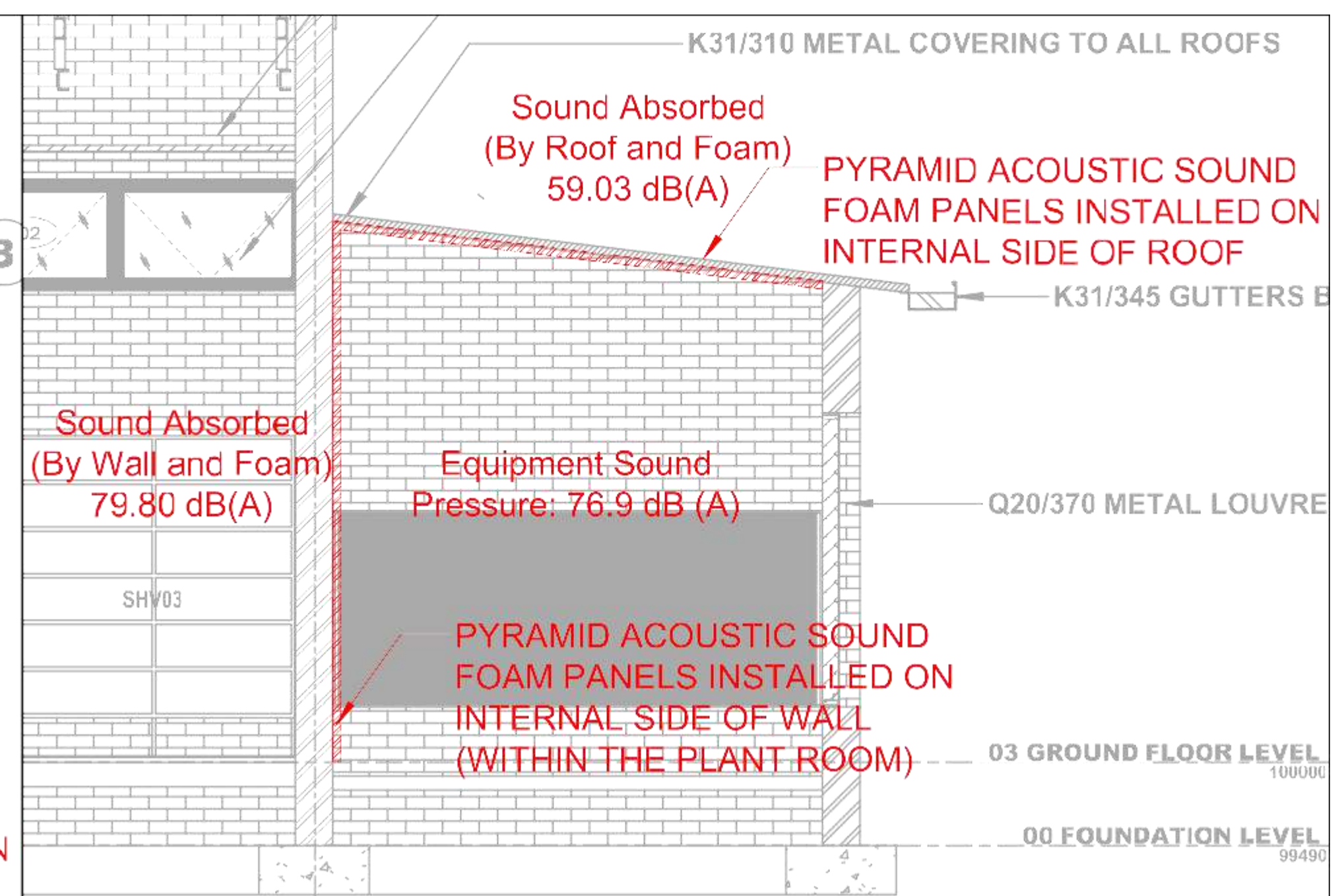
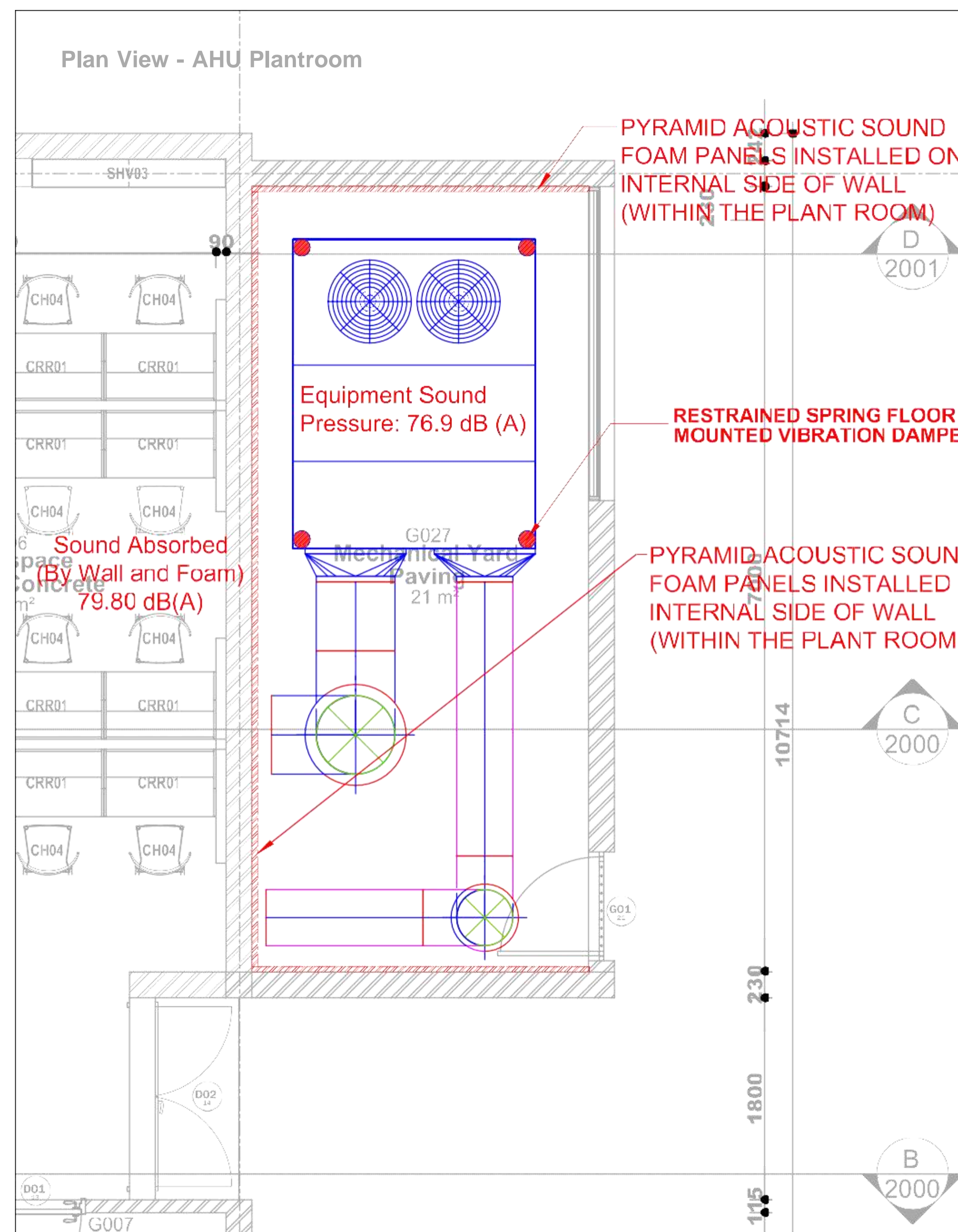

Section View - AHU Plantroom

AHU Vibration Dampers

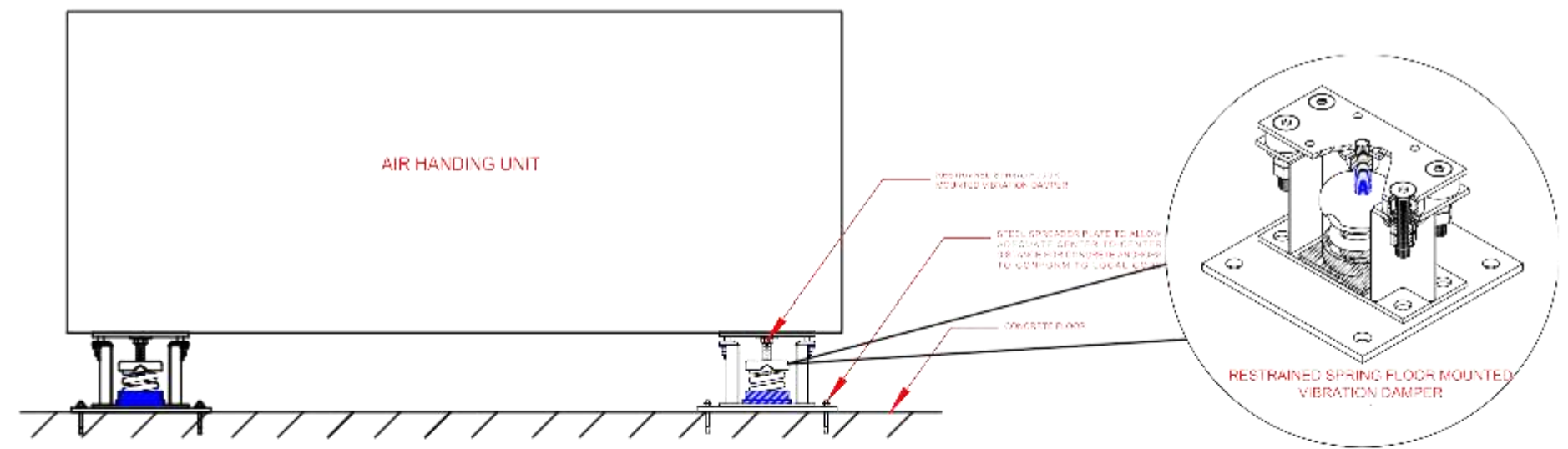

Restrained Spring Floor Mounted Vibration Dampers - Vibration Dampers for equipment which is subject to load variations and large external or torquing forces shall consist of large diameter laterally stable steel springs assembled into formed or welded steel housing assemblies designed to limit vertical movement of the supported equipment. Springs shall be supported either with a neoprene cup of a metal base plate complete with a ribbed neoprene pad, minimum 6 mm thick, bonded to the base plate. Housing assembly shall be formed or fabricated steel members and shall consist of a top-load plate complete with adjusting and leveling bolts, vertical restraints, isolation washers and a bottom plate with non-skid noise stop pads and holes provided for anchoring to supporting structure. Housing shall be hot dipped galvanized. Spring elements shall meet all the specified characteristics.

NOTES: 1. DETAILED DESIGN	LEGEND:	DESIGNED BY: TCM	CLIENT: LIMPOPO PUBLIC WORKS, ROADS & INFRASTRUCTURE	CONSULTANT: SUPERIOR	DRAWING TITLE: ACOUSTICS AND VIBRATION DAMPING	DRAWING NUMBER: LDPW-301-MEC-008	PAPER SIZE: A1
		CHECKED BY: BN	LIMPOPO: DPWI 43 CHURCH STREET POLKOVANE 0700 TEL: 015 - 284 7000 FAX: 1	LIMPOPO: DSAC 43 BICCARD STREET POLKOVANE 0700 TEL: 065 94 4000 FAX: 1	PROJECT TITLE: NEW LIBRARIES FOR THE LIMPOPO DEPARTMENT OF SPORTS, ART AND CULTURE (DSAC)	PROJECT NUMBER: LDPWI/21-22	SCALE: N/A
		DRAWN BY: TCM			LIBRARY NAME:	CONTRACT No: LDPWRI-PROF/18005	
		APPROVED BY: BN					

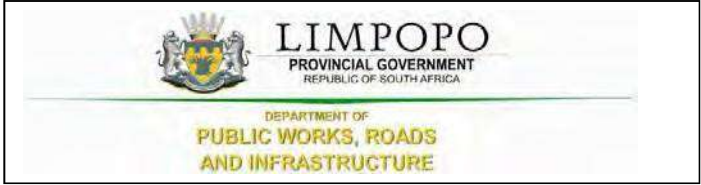

PART C7.2. 4: STRUCTURAL SPECIFICATIONS AND DRAWINGS

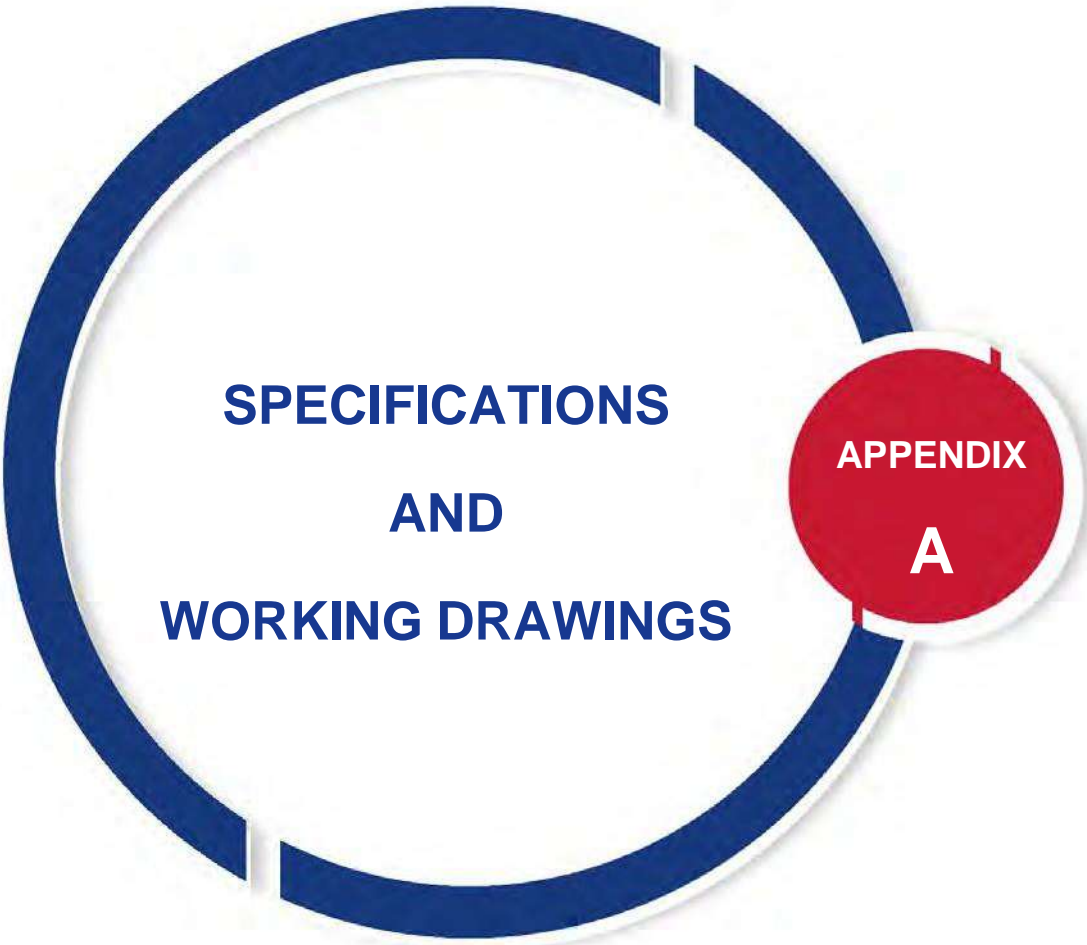

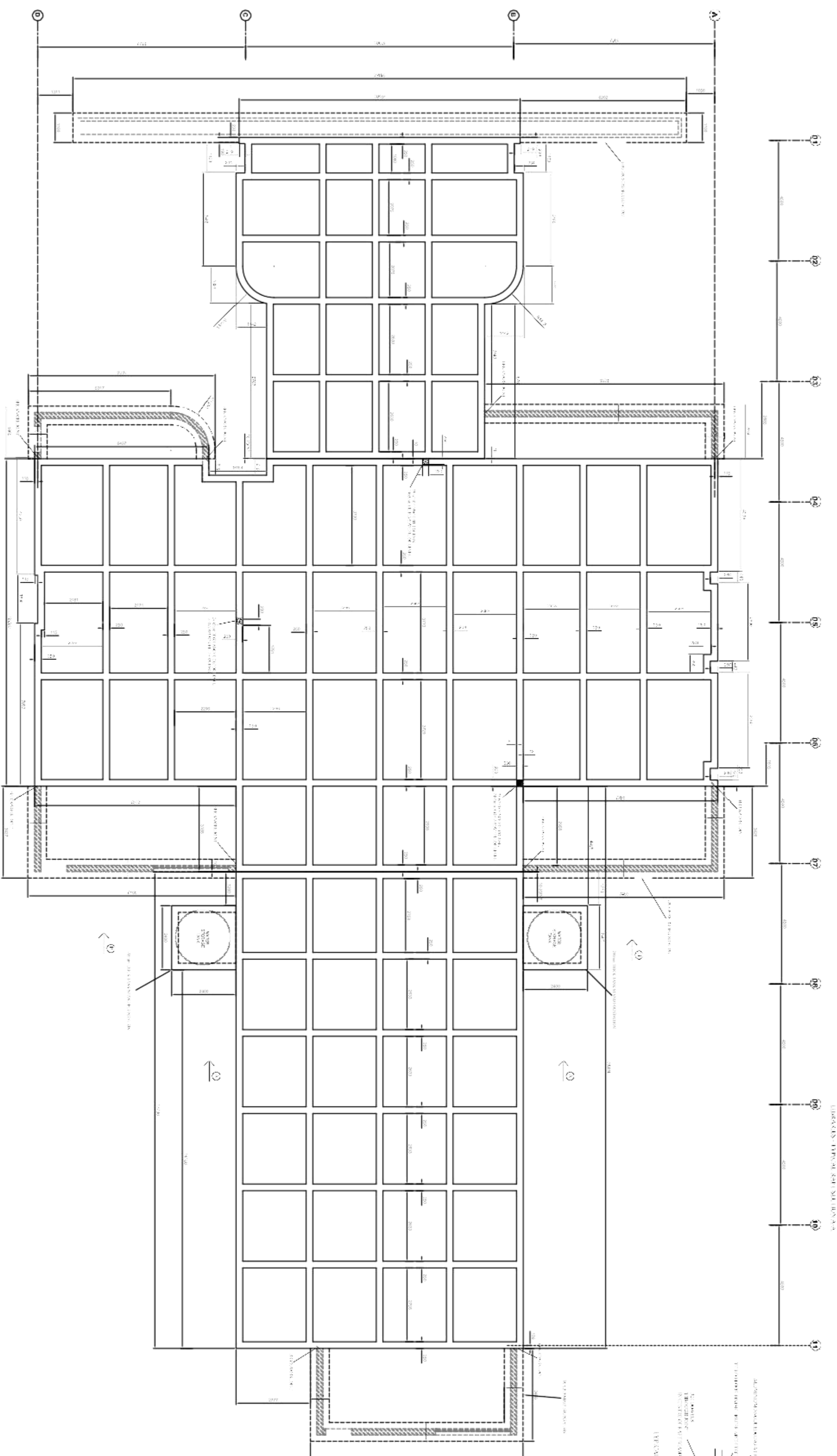
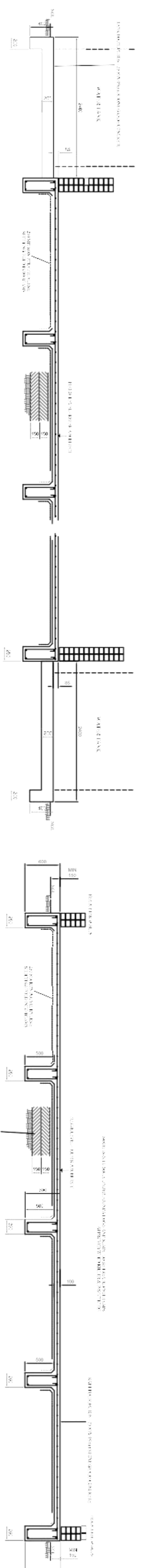

NO.	DATE	DESCRIPTION	ISSUED FOR	BY
A	2021-9-13	ISSUED FOR TENDER		

CONSULTANT DETAILS
 KIN CONSULTING ENGINEERS AND
 PROJECT MANAGERS
 THORNHILL OFFICE PARK,
 BUILDING 27, SUITE F9
 52 BEKKER ROAD, MIDRAND.



TEL NO.: +27 (0) 11 805 0981
 FAX NO.: +27 (0) 11 604 0039
 EMAIL: KTN@KTNCONSULTING.CO.ZA
 WEBSITE: www.kinconsulting.co.za

DEPARTMENT OF PUBLIC WORKS
 PHYSICAL: COHNER RIVER AND
 BLAUBERG STREET
 LADANNANA
 POLOKwane

DESIGNED BY: PETER BEN VAN ASSBIE
 DRAWING CHECKED BY: K. MAMAYISE
 DRAWING APPROVED BY: NIKHILA MUDUNA

PROJECT TITLE:
 CONSTRUCTION OF FOUR (4) NEW LIBRARIES
 FOR THE LIMPOPO DEPARTMENT OF SPORT,
 ART AND CULTURE (DSACA).
 LIBRARY RAFT FOUNDATION DETAILS

NO.	DATE	DESCRIPTION
1	1906-001	1306-001

PROJECT STATUS
 KIN CONSULTING ENGINEERS AND PROJECT MANAGERS
 1306-001



1. ALL DIMENSIONS ARE IN METERS UNLESS OTHERWISE SPECIFIED.
2. DIMENSIONS ARE TO FACE UNLESS OTHERWISE SPECIFIED.
3. DIMENSIONS ARE TO CENTERLINE UNLESS OTHERWISE SPECIFIED.
4. DIMENSIONS ARE TO CENTERLINE UNLESS OTHERWISE SPECIFIED.
5. DIMENSIONS ARE TO CENTERLINE UNLESS OTHERWISE SPECIFIED.
6. DIMENSIONS ARE TO CENTERLINE UNLESS OTHERWISE SPECIFIED.
7. DIMENSIONS ARE TO CENTERLINE UNLESS OTHERWISE SPECIFIED.
8. DIMENSIONS ARE TO CENTERLINE UNLESS OTHERWISE SPECIFIED.
9. DIMENSIONS ARE TO CENTERLINE UNLESS OTHERWISE SPECIFIED.
10. DIMENSIONS ARE TO CENTERLINE UNLESS OTHERWISE SPECIFIED.
11. DIMENSIONS ARE TO CENTERLINE UNLESS OTHERWISE SPECIFIED.
12. DIMENSIONS ARE TO CENTERLINE UNLESS OTHERWISE SPECIFIED.
13. DIMENSIONS ARE TO CENTERLINE UNLESS OTHERWISE SPECIFIED.
14. DIMENSIONS ARE TO CENTERLINE UNLESS OTHERWISE SPECIFIED.
15. DIMENSIONS ARE TO CENTERLINE UNLESS OTHERWISE SPECIFIED.

NO.	REVISION	DATE
1	ISSUED FOR TENDER	2021-09-13
2		
3		
4		
5		
6		
7		
8		
9		
10		
11		
12		
13		
14		
15		

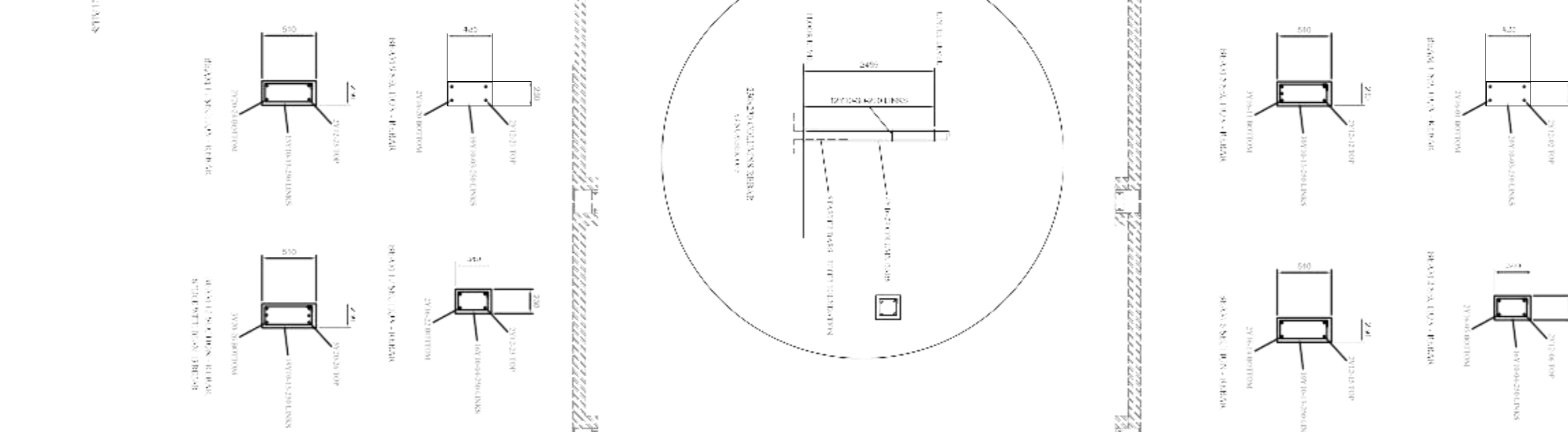
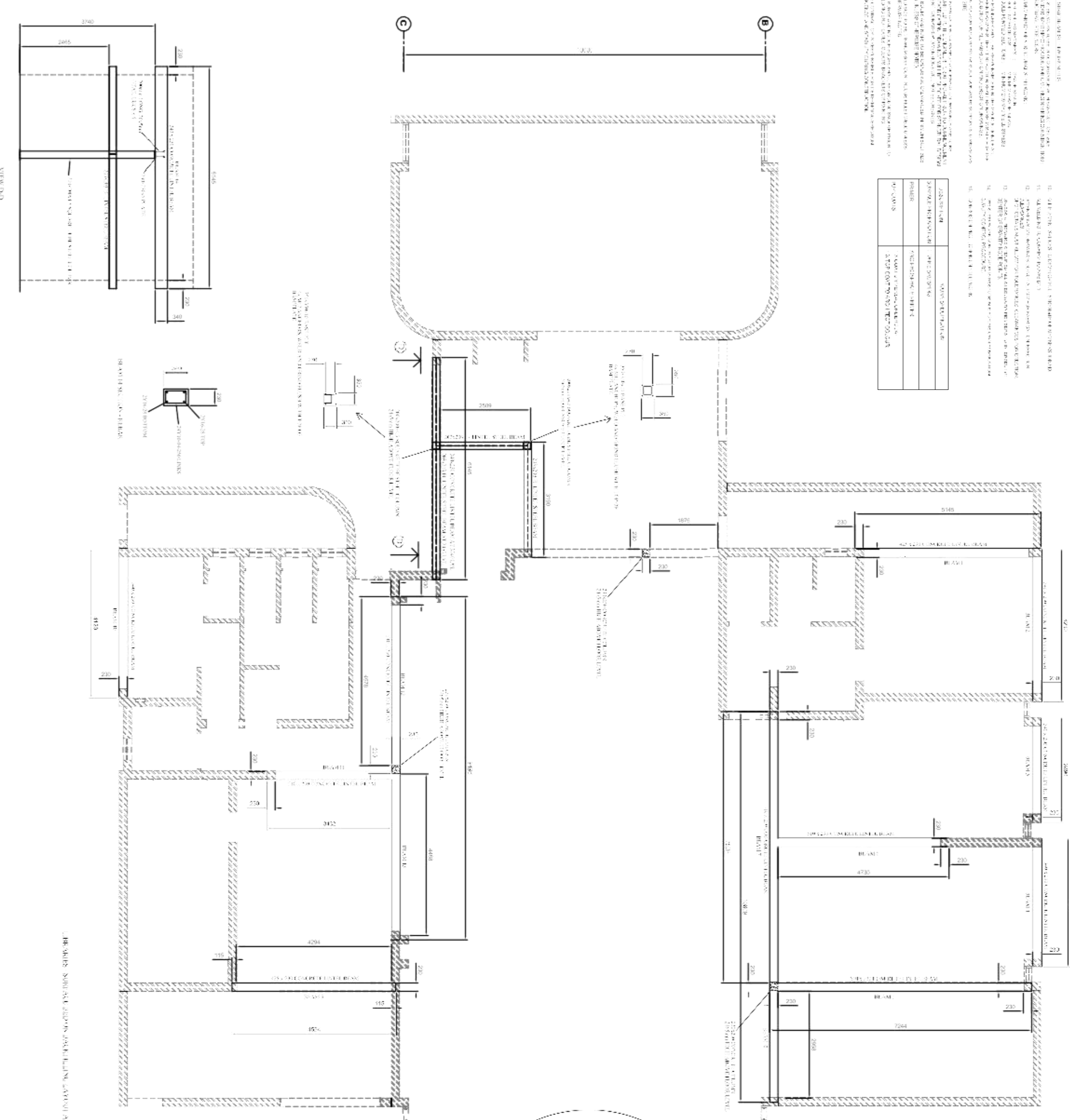

NO.	MARK	QTY	UNIT	DESCRIPTION	NO.	MARK	QTY	UNIT	DESCRIPTION
01	W200	2	M	W200x200x25	01	W200	2	M	W200x200x25
02	W250	2	M	W250x250x35	02	W250	2	M	W250x250x35
03	W300	2	M	W300x300x45	03	W300	2	M	W300x300x45
04	W350	2	M	W350x350x55	04	W350	2	M	W350x350x55
05	W400	2	M	W400x400x65	05	W400	2	M	W400x400x65
06	W450	2	M	W450x450x75	06	W450	2	M	W450x450x75
07	W500	2	M	W500x500x85	07	W500	2	M	W500x500x85
08	W550	2	M	W550x550x95	08	W550	2	M	W550x550x95
09	W600	2	M	W600x600x105	09	W600	2	M	W600x600x105
10	W650	2	M	W650x650x115	10	W650	2	M	W650x650x115
11	W700	2	M	W700x700x125	11	W700	2	M	W700x700x125
12	W750	2	M	W750x750x135	12	W750	2	M	W750x750x135
13	W800	2	M	W800x800x145	13	W800	2	M	W800x800x145
14	W850	2	M	W850x850x155	14	W850	2	M	W850x850x155
15	W900	2	M	W900x900x165	15	W900	2	M	W900x900x165
16	W950	2	M	W950x950x175	16	W950	2	M	W950x950x175
17	W1000	2	M	W1000x1000x185	17	W1000	2	M	W1000x1000x185
18	W1050	2	M	W1050x1050x195	18	W1050	2	M	W1050x1050x195
19	W1100	2	M	W1100x1100x205	19	W1100	2	M	W1100x1100x205
20	W1150	2	M	W1150x1150x215	20	W1150	2	M	W1150x1150x215
21	W1200	2	M	W1200x1200x225	21	W1200	2	M	W1200x1200x225
22	W1250	2	M	W1250x1250x235	22	W1250	2	M	W1250x1250x235
23	W1300	2	M	W1300x1300x245	23	W1300	2	M	W1300x1300x245
24	W1350	2	M	W1350x1350x255	24	W1350	2	M	W1350x1350x255
25	W1400	2	M	W1400x1400x265	25	W1400	2	M	W1400x1400x265
26	W1450	2	M	W1450x1450x275	26	W1450	2	M	W1450x1450x275
27	W1500	2	M	W1500x1500x285	27	W1500	2	M	W1500x1500x285
28	W1550	2	M	W1550x1550x295	28	W1550	2	M	W1550x1550x295
29	W1600	2	M	W1600x1600x305	29	W1600	2	M	W1600x1600x305
30	W1650	2	M	W1650x1650x315	30	W1650	2	M	W1650x1650x315
31	W1700	2	M	W1700x1700x325	31	W1700	2	M	W1700x1700x325
32	W1750	2	M	W1750x1750x335	32	W1750	2	M	W1750x1750x335
33	W1800	2	M	W1800x1800x345	33	W1800	2	M	W1800x1800x345
34	W1850	2	M	W1850x1850x355	34	W1850	2	M	W1850x1850x355
35	W1900	2	M	W1900x1900x365	35	W1900	2	M	W1900x1900x365
36	W1950	2	M	W1950x1950x375	36	W1950	2	M	W1950x1950x375
37	W2000	2	M	W2000x2000x385	37	W2000	2	M	W2000x2000x385
38	W2050	2	M	W2050x2050x395	38	W2050	2	M	W2050x2050x395
39	W2100	2	M	W2100x2100x405	39	W2100	2	M	W2100x2100x405
40	W2150	2	M	W2150x2150x415	40	W2150	2	M	W2150x2150x415
41	W2200	2	M	W2200x2200x425	41	W2200	2	M	W2200x2200x425
42	W2250	2	M	W2250x2250x435	42	W2250	2	M	W2250x2250x435
43	W2300	2	M	W2300x2300x445	43	W2300	2	M	W2300x2300x445
44	W2350	2	M	W2350x2350x455	44	W2350	2	M	W2350x2350x455
45	W2400	2	M	W2400x2400x465	45	W2400	2	M	W2400x2400x465
46	W2450	2	M	W2450x2450x475	46	W2450	2	M	W2450x2450x475
47	W2500	2	M	W2500x2500x485	47	W2500	2	M	W2500x2500x485
48	W2550	2	M	W2550x2550x495	48	W2550	2	M	W2550x2550x495
49	W2600	2	M	W2600x2600x505	49	W2600	2	M	W2600x2600x505
50	W2650	2	M	W2650x2650x515	50	W2650	2	M	W2650x2650x515

1. ALL DIMENSIONS ARE IN METERS UNLESS OTHERWISE SPECIFIED.

2. DIMENSIONS ARE TO FACE UNLESS OTHERWISE SPECIFIED.

3. DIMENSIONS ARE TO CENTERLINE UNLESS OTHERWISE SPECIFIED.

4. DIMENSIONS ARE TO CENTERLINE UNLESS OTHERWISE SPECIFIED.

5. DIMENSIONS ARE TO CENTERLINE UNLESS OTHERWISE SPECIFIED.

6. DIMENSIONS ARE TO CENTERLINE UNLESS OTHERWISE SPECIFIED.

7. DIMENSIONS ARE TO CENTERLINE UNLESS OTHERWISE SPECIFIED.

8. DIMENSIONS ARE TO CENTERLINE UNLESS OTHERWISE SPECIFIED.

9. DIMENSIONS ARE TO CENTERLINE UNLESS OTHERWISE SPECIFIED.

10. DIMENSIONS ARE TO CENTERLINE UNLESS OTHERWISE SPECIFIED.

11. DIMENSIONS ARE TO CENTERLINE UNLESS OTHERWISE SPECIFIED.

12. DIMENSIONS ARE TO CENTERLINE UNLESS OTHERWISE SPECIFIED.

13. DIMENSIONS ARE TO CENTERLINE UNLESS OTHERWISE SPECIFIED.

14. DIMENSIONS ARE TO CENTERLINE UNLESS OTHERWISE SPECIFIED.

15. DIMENSIONS ARE TO CENTERLINE UNLESS OTHERWISE SPECIFIED.

16. DIMENSIONS ARE TO CENTERLINE UNLESS OTHERWISE SPECIFIED.

17. DIMENSIONS ARE TO CENTERLINE UNLESS OTHERWISE SPECIFIED.

18. DIMENSIONS ARE TO CENTERLINE UNLESS OTHERWISE SPECIFIED.

19. DIMENSIONS ARE TO CENTERLINE UNLESS OTHERWISE SPECIFIED.

20. DIMENSIONS ARE TO CENTERLINE UNLESS OTHERWISE SPECIFIED.

21. DIMENSIONS ARE TO CENTERLINE UNLESS OTHERWISE SPECIFIED.

22. DIMENSIONS ARE TO CENTERLINE UNLESS OTHERWISE SPECIFIED.

23. DIMENSIONS ARE TO CENTERLINE UNLESS OTHERWISE SPECIFIED.

24. DIMENSIONS ARE TO CENTERLINE UNLESS OTHERWISE SPECIFIED.

25. DIMENSIONS ARE TO CENTERLINE UNLESS OTHERWISE SPECIFIED.

26. DIMENSIONS ARE TO CENTERLINE UNLESS OTHERWISE SPECIFIED.

27. DIMENSIONS ARE TO CENTERLINE UNLESS OTHERWISE SPECIFIED.

28. DIMENSIONS ARE TO CENTERLINE UNLESS OTHERWISE SPECIFIED.

29. DIMENSIONS ARE TO CENTERLINE UNLESS OTHERWISE SPECIFIED.

30. DIMENSIONS ARE TO CENTERLINE UNLESS OTHERWISE SPECIFIED.

31. DIMENSIONS ARE TO CENTERLINE UNLESS OTHERWISE SPECIFIED.

32. DIMENSIONS ARE TO CENTERLINE UNLESS OTHERWISE SPECIFIED.

33. DIMENSIONS ARE TO CENTERLINE UNLESS OTHERWISE SPECIFIED.

34. DIMENSIONS ARE TO CENTERLINE UNLESS OTHERWISE SPECIFIED.

35. DIMENSIONS ARE TO CENTERLINE UNLESS OTHERWISE SPECIFIED.

36. DIMENSIONS ARE TO CENTERLINE UNLESS OTHERWISE SPECIFIED.

37. DIMENSIONS ARE TO CENTERLINE UNLESS OTHERWISE SPECIFIED.

38. DIMENSIONS ARE TO CENTERLINE UNLESS OTHERWISE SPECIFIED.

39. DIMENSIONS ARE TO CENTERLINE UNLESS OTHERWISE SPECIFIED.

40. DIMENSIONS ARE TO CENTERLINE UNLESS OTHERWISE SPECIFIED.

41. DIMENSIONS ARE TO CENTERLINE UNLESS OTHERWISE SPECIFIED.

42. DIMENSIONS ARE TO CENTERLINE UNLESS OTHERWISE SPECIFIED.

43. DIMENSIONS ARE TO CENTERLINE UNLESS OTHERWISE SPECIFIED.

44. DIMENSIONS ARE TO CENTERLINE UNLESS OTHERWISE SPECIFIED.

45. DIMENSIONS ARE TO CENTERLINE UNLESS OTHERWISE SPECIFIED.

46. DIMENSIONS ARE TO CENTERLINE UNLESS OTHERWISE SPECIFIED.

47. DIMENSIONS ARE TO CENTERLINE UNLESS OTHERWISE SPECIFIED.

48. DIMENSIONS ARE TO CENTERLINE UNLESS OTHERWISE SPECIFIED.

49. DIMENSIONS ARE TO CENTERLINE UNLESS OTHERWISE SPECIFIED.

50. DIMENSIONS ARE TO CENTERLINE UNLESS OTHERWISE SPECIFIED.

NO.	DATE	DESCRIPTION	BY
1	2021-09-13	ISSUED FOR TENDER	PKA
2			
3			
4			
5			
6			
7			
8			
9			
10			
11			
12			
13			
14			
15			

CONSULTANT DETAILS
KIN CONSULTING ENGINEERS AND PROJECT MANAGERS
 THORNHILL OFFICE PARK,
 BUILDING 27, SUITE F9
 52 BEKKER ROAD, MIDRAND.

TEL NO.: +27 (0) 11 805 0981
 FAX NO.: +27 (0) 11 604 0039
 EMAIL: KTN@KTNCONSULTING.CO.ZA
 WEBSITE: www.ktnconsulting.co.za

DEPARTMENT OF PUBLIC WORKS
 PHYSICAL: COHNER RIVER AND BLAUBERG SHEET 1ADANNA POLOKWANE

TEL NO 015 284 7400/1
 FAX/AIL: NEWSROOM@DPW.LIMPOPO.GOV.ZA

PROJECT: CONSTRUCTION OF FOUR (4) NEW LIBRARIES FOR THE LIMPOPO DEPARTMENT OF SPORT, ART AND CULTURE (DSACA).

STRUCTURAL COLUMNS AND BEAMS

PROJECT STATUS

DATE: 2021-09-13

SCALE: 1:100

DATE: SEPTEMBER 2021

NO. OF SHEETS: 0

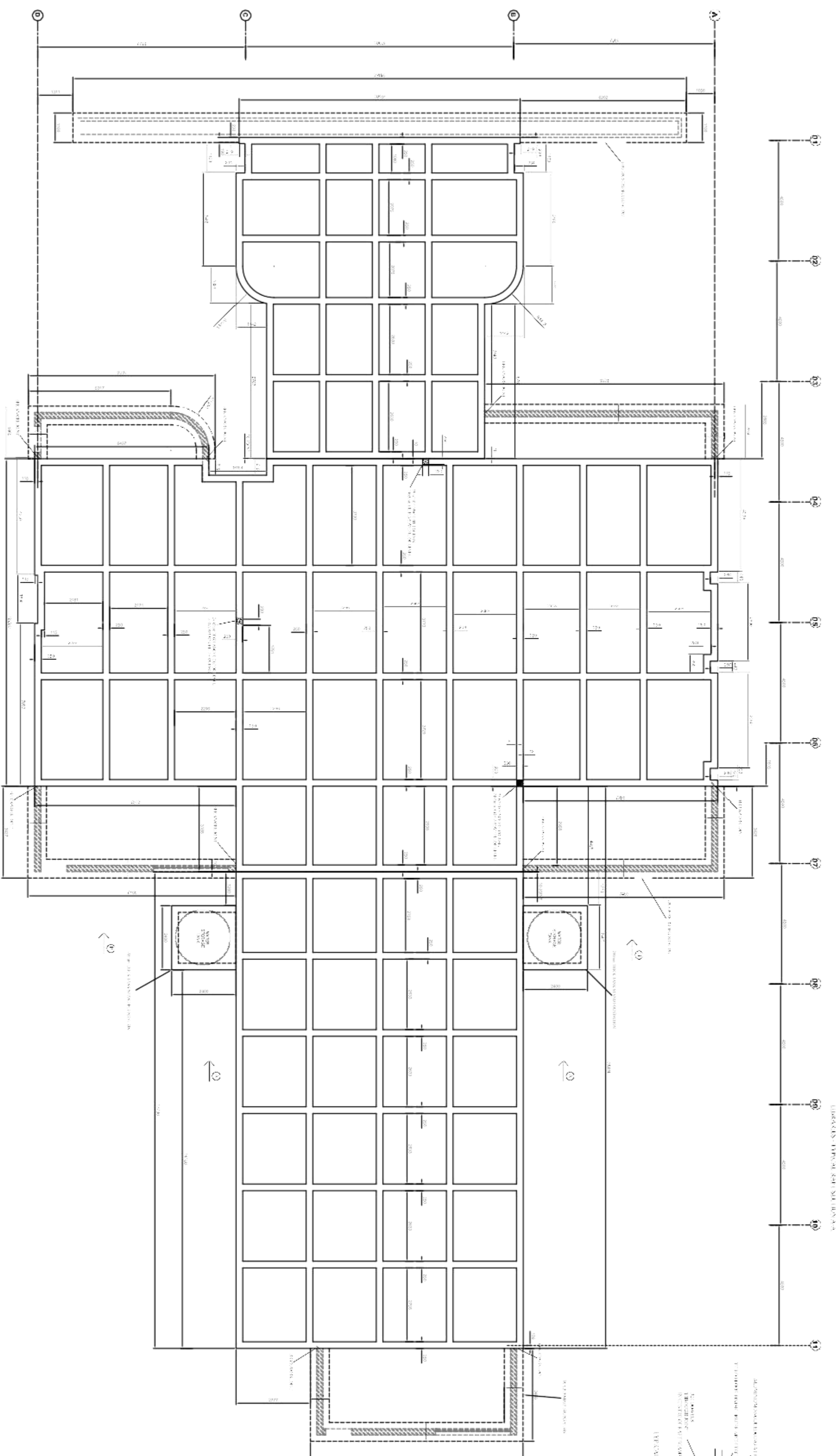
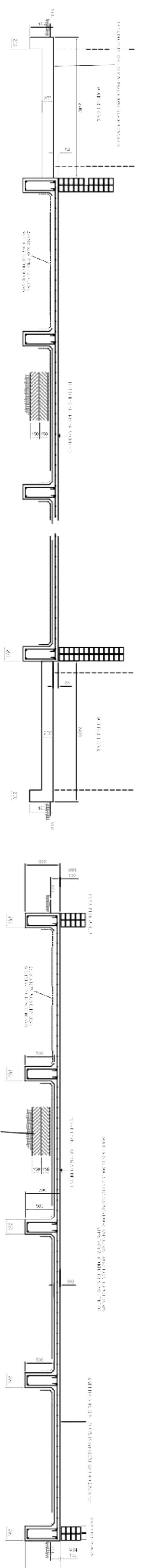

NO.	DATE	DESCRIPTION	ISSUED FOR	BY
A	2021-9-13	ISSUED FOR TENDER		

CONSULTANT DETAILS
 KIN CONSULTING ENGINEERS AND
 PROJECT MANAGERS
 THORNHILL OFFICE PARK,
 BUILDING 27, SUITE F9
 52 BEKKER ROAD, MIDRAND.



TEL NO.: +27 (0) 11 805 0981
 FAX NO.: +27 (0) 11 604 0039
 EMAIL: KTN@KINCONSULTING.CO.ZA
 WEBSITE: www.kinconsulting.co.za

DEPARTMENT OF PUBLIC WORKS
 PHYSICAL: COHNER RIVER AND
 BLAUBERG STREET
 LADANNANA
 POLOKWANE

DESIGNED BY: PETER BEN VAN ASSBIE
 DRAWING CHECKED BY: K. MAMAYISE
 DATE: 13/09/2021

PROJECT TITLE:
 CONSTRUCTION OF FOUR (4) NEW LIBRARIES
 FOR THE LIMPOPO DEPARTMENT OF SPORT,
 ART AND CULTURE (DSACA).
 LIBRARY RAFT FOUNDATION DETAILS

PROJECT NO.: 1905-001
 DATE: SEPTEMBER 2021

NO.	DATE	DESCRIPTION	ISSUED FOR	BY
1	13/09/2021	ISSUED FOR TENDER		

PROJECT STATUS
 PROJECT NO.: 1905-001
 DATE: SEPTEMBER 2021

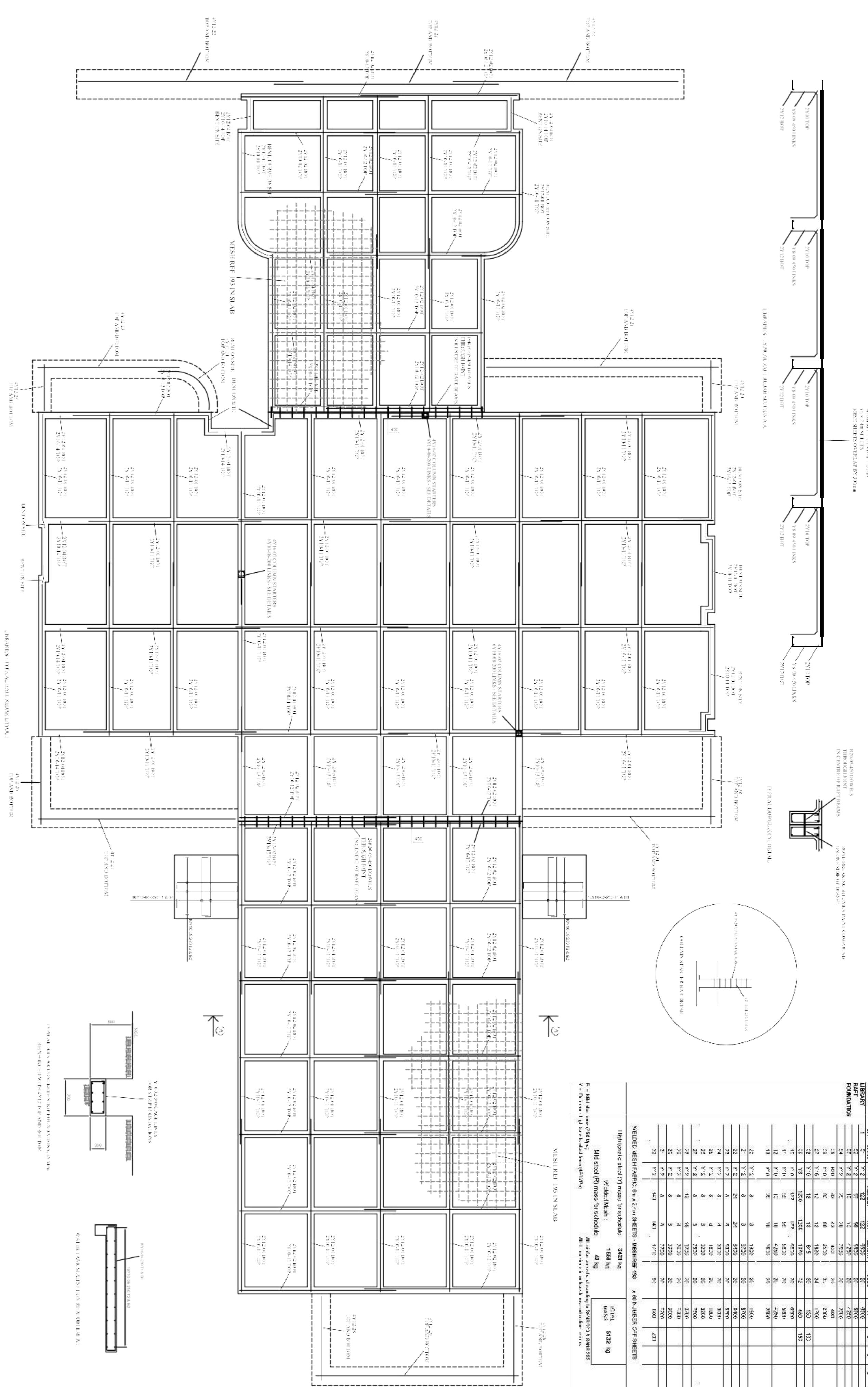

MEMBER	NO	BAR	LEN	BAWS	TOTAL	CUT	SHADE	A	B	C	D	ET
LIBRARY	1	2	12	12	950	80	800					
RAFT	2	2	12	12	950	80	800					
FOUNDATION	3	2	12	12	950	80	800					
	4	2	12	12	950	80	800					
	5	2	12	12	950	80	800					
	6	2	12	12	950	80	800					
	7	2	12	12	950	80	800					
	8	2	12	12	950	80	800					
	9	2	12	12	950	80	800					
	10	2	12	12	950	80	800					
	11	2	12	12	950	80	800					
	12	2	12	12	950	80	800					
	13	2	12	12	950	80	800					
	14	2	12	12	950	80	800					
	15	2	12	12	950	80	800					
	16	2	12	12	950	80	800					
	17	2	12	12	950	80	800					
	18	2	12	12	950	80	800					
	19	2	12	12	950	80	800					
	20	2	12	12	950	80	800					
	21	2	12	12	950	80	800					
	22	2	12	12	950	80	800					
	23	2	12	12	950	80	800					
	24	2	12	12	950	80	800					
	25	2	12	12	950	80	800					
	26	2	12	12	950	80	800					
	27	2	12	12	950	80	800					
	28	2	12	12	950	80	800					
	29	2	12	12	950	80	800					
	30	2	12	12	950	80	800					
	31	2	12	12	950	80	800					
	32	2	12	12	950	80	800					

AMENDMENTS WK. DATE DESCRIPTION FOR TENDER PAK. PBA.		CONSULTANT DETAILS KIN CONSULTING ENGINEERS AND PROJECT MANAGERS THORNHILL OFFICE PARK, BUILDING 27, SUITE F9 52 BEKKER ROAD, MIDRAND. TEL NO.: +27 (0) 11 805 0981 FAX NO.: +27 (0) 11 604 0039 EMAIL: KTN@KTNCONSULTING.CO.ZA WEBSITE: www.ktnconsulting.co.za	
ROADS AND STRUCTURES DIRECTOR: ... DIRECTOR: ... DIRECTOR: ...		DEPARTMENT OF PUBLIC WORKS PHYSICAL: ... COORNER RIVER AND BLAUBERG STREET LADANNANA POLOKWANE TEL NO 015 284 7400/1 FAX/AIL: ... NEWSROOM@DPW.LIMPOPO.GOV.ZA	
LIBRARY RAFT FOUNDATION REINFORCEMENT PROJECT NO: 1905 SCALE: 1:100 DATE: SEPTEMBER 2021		PROJECT STATUS PROJECT NO: 1905-002 SCALE: 1:100 DATE: SEPTEMBER 2021	



1. ALL DIMENSIONS ARE IN METERS UNLESS OTHERWISE SPECIFIED.
2. ALL DIMENSIONS ARE TO FACE UNLESS OTHERWISE SPECIFIED.
3. ALL DIMENSIONS ARE TO FACE UNLESS OTHERWISE SPECIFIED.
4. ALL DIMENSIONS ARE TO FACE UNLESS OTHERWISE SPECIFIED.
5. ALL DIMENSIONS ARE TO FACE UNLESS OTHERWISE SPECIFIED.
6. ALL DIMENSIONS ARE TO FACE UNLESS OTHERWISE SPECIFIED.
7. ALL DIMENSIONS ARE TO FACE UNLESS OTHERWISE SPECIFIED.
8. ALL DIMENSIONS ARE TO FACE UNLESS OTHERWISE SPECIFIED.
9. ALL DIMENSIONS ARE TO FACE UNLESS OTHERWISE SPECIFIED.
10. ALL DIMENSIONS ARE TO FACE UNLESS OTHERWISE SPECIFIED.
11. ALL DIMENSIONS ARE TO FACE UNLESS OTHERWISE SPECIFIED.
12. ALL DIMENSIONS ARE TO FACE UNLESS OTHERWISE SPECIFIED.
13. ALL DIMENSIONS ARE TO FACE UNLESS OTHERWISE SPECIFIED.
14. ALL DIMENSIONS ARE TO FACE UNLESS OTHERWISE SPECIFIED.
15. ALL DIMENSIONS ARE TO FACE UNLESS OTHERWISE SPECIFIED.

NO.	REVISION	DATE
1	ISSUED FOR TENDER	2021-09-13

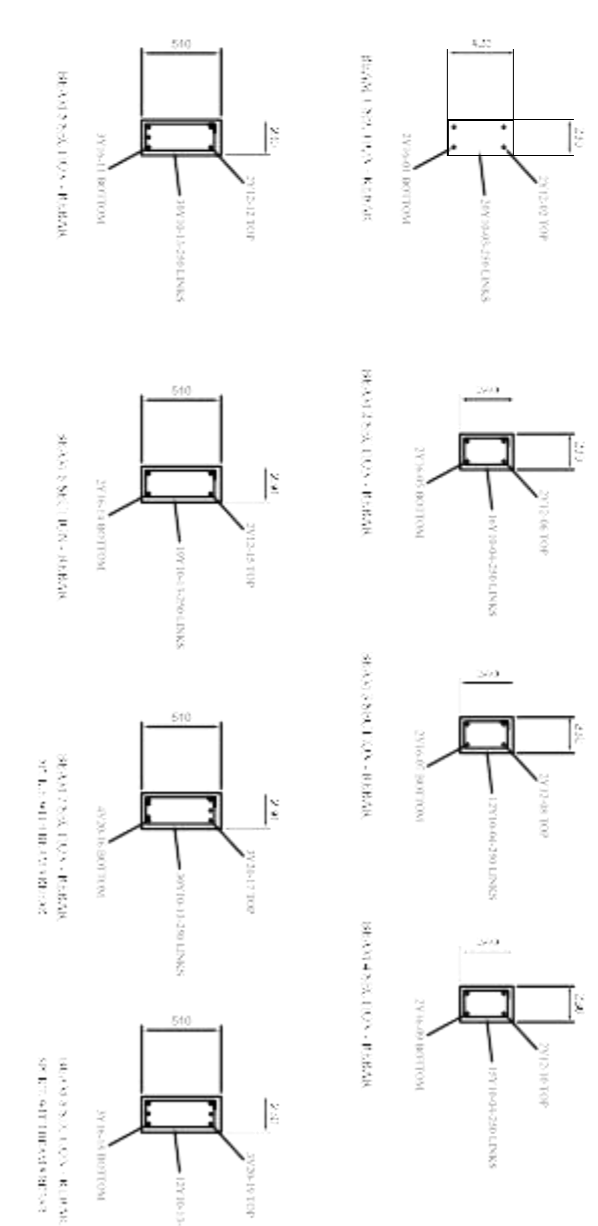
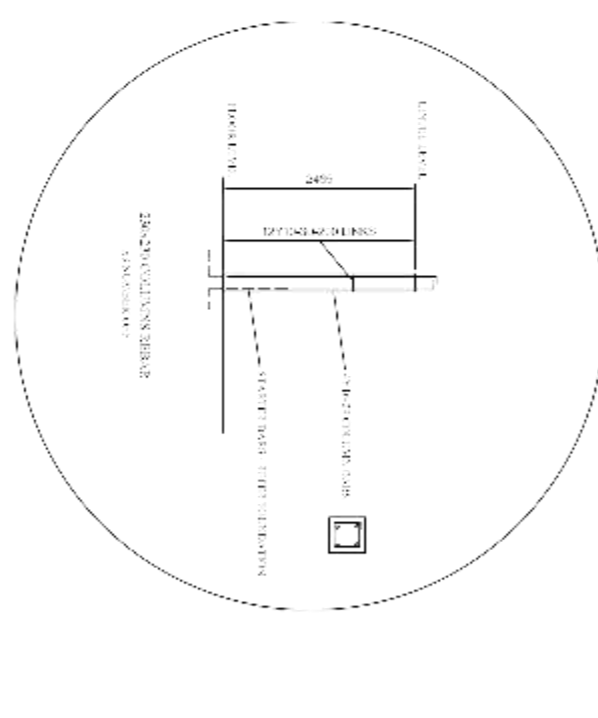
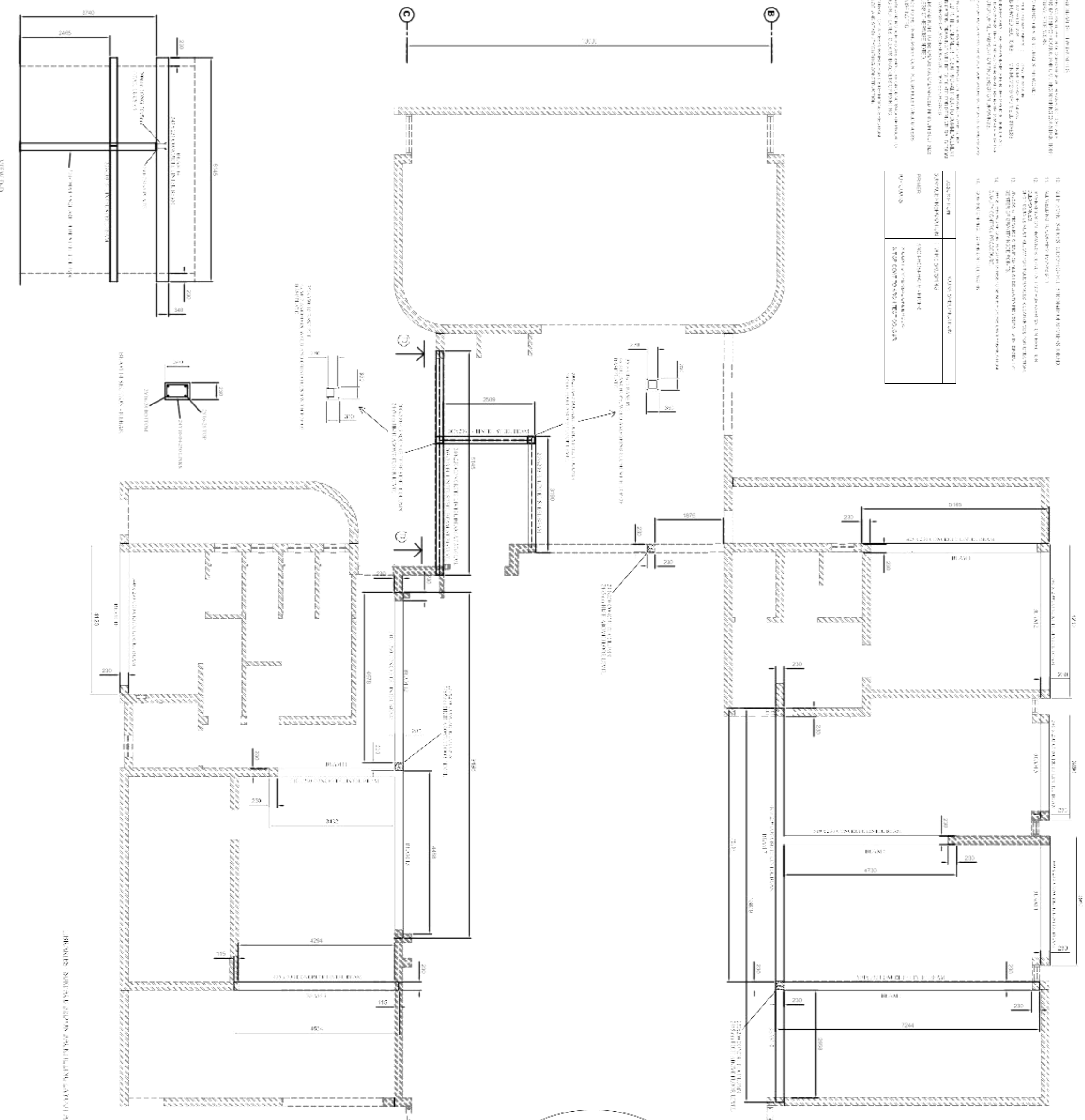

NO.	MARK	SIZE	REMARKS	NO.	MARK	SIZE	REMARKS
01	W16	400	400	01	W16	400	400
02	W16	400	400	02	W16	400	400
03	W16	400	400	03	W16	400	400
04	W16	400	400	04	W16	400	400
05	W16	400	400	05	W16	400	400
06	W16	400	400	06	W16	400	400
07	W16	400	400	07	W16	400	400
08	W16	400	400	08	W16	400	400
09	W16	400	400	09	W16	400	400
10	W16	400	400	10	W16	400	400
11	W16	400	400	11	W16	400	400
12	W16	400	400	12	W16	400	400
13	W16	400	400	13	W16	400	400
14	W16	400	400	14	W16	400	400
15	W16	400	400	15	W16	400	400
16	W16	400	400	16	W16	400	400
17	W16	400	400	17	W16	400	400
18	W16	400	400	18	W16	400	400
19	W16	400	400	19	W16	400	400
20	W16	400	400	20	W16	400	400
21	W16	400	400	21	W16	400	400
22	W16	400	400	22	W16	400	400
23	W16	400	400	23	W16	400	400
24	W16	400	400	24	W16	400	400
25	W16	400	400	25	W16	400	400
26	W16	400	400	26	W16	400	400
27	W16	400	400	27	W16	400	400
28	W16	400	400	28	W16	400	400
29	W16	400	400	29	W16	400	400
30	W16	400	400	30	W16	400	400

1. ALL DIMENSIONS ARE IN METERS UNLESS OTHERWISE SPECIFIED.
2. ALL DIMENSIONS ARE TO FACE UNLESS OTHERWISE SPECIFIED.
3. ALL DIMENSIONS ARE TO FACE UNLESS OTHERWISE SPECIFIED.
4. ALL DIMENSIONS ARE TO FACE UNLESS OTHERWISE SPECIFIED.
5. ALL DIMENSIONS ARE TO FACE UNLESS OTHERWISE SPECIFIED.
6. ALL DIMENSIONS ARE TO FACE UNLESS OTHERWISE SPECIFIED.
7. ALL DIMENSIONS ARE TO FACE UNLESS OTHERWISE SPECIFIED.
8. ALL DIMENSIONS ARE TO FACE UNLESS OTHERWISE SPECIFIED.
9. ALL DIMENSIONS ARE TO FACE UNLESS OTHERWISE SPECIFIED.
10. ALL DIMENSIONS ARE TO FACE UNLESS OTHERWISE SPECIFIED.
11. ALL DIMENSIONS ARE TO FACE UNLESS OTHERWISE SPECIFIED.
12. ALL DIMENSIONS ARE TO FACE UNLESS OTHERWISE SPECIFIED.
13. ALL DIMENSIONS ARE TO FACE UNLESS OTHERWISE SPECIFIED.
14. ALL DIMENSIONS ARE TO FACE UNLESS OTHERWISE SPECIFIED.
15. ALL DIMENSIONS ARE TO FACE UNLESS OTHERWISE SPECIFIED.
16. ALL DIMENSIONS ARE TO FACE UNLESS OTHERWISE SPECIFIED.
17. ALL DIMENSIONS ARE TO FACE UNLESS OTHERWISE SPECIFIED.
18. ALL DIMENSIONS ARE TO FACE UNLESS OTHERWISE SPECIFIED.
19. ALL DIMENSIONS ARE TO FACE UNLESS OTHERWISE SPECIFIED.
20. ALL DIMENSIONS ARE TO FACE UNLESS OTHERWISE SPECIFIED.
21. ALL DIMENSIONS ARE TO FACE UNLESS OTHERWISE SPECIFIED.
22. ALL DIMENSIONS ARE TO FACE UNLESS OTHERWISE SPECIFIED.
23. ALL DIMENSIONS ARE TO FACE UNLESS OTHERWISE SPECIFIED.
24. ALL DIMENSIONS ARE TO FACE UNLESS OTHERWISE SPECIFIED.
25. ALL DIMENSIONS ARE TO FACE UNLESS OTHERWISE SPECIFIED.
26. ALL DIMENSIONS ARE TO FACE UNLESS OTHERWISE SPECIFIED.
27. ALL DIMENSIONS ARE TO FACE UNLESS OTHERWISE SPECIFIED.
28. ALL DIMENSIONS ARE TO FACE UNLESS OTHERWISE SPECIFIED.
29. ALL DIMENSIONS ARE TO FACE UNLESS OTHERWISE SPECIFIED.
30. ALL DIMENSIONS ARE TO FACE UNLESS OTHERWISE SPECIFIED.

NO.	DATE	DESCRIPTION	BY
1	2021-09-13	ISSUED FOR TENDER	PKA

CONSULTANT DETAILS
KIN CONSULTING ENGINEERS AND PROJECT MANAGERS
 THORNHILL OFFICE PARK,
 BUILDING 27, SUITE F9
 52 BEKKER ROAD, MIDRAND.

TEL NO.: +27 (0) 11 805 0981
 FAX NO.: +27 (0) 11 604 0039
 EMAIL: KTN@KTNCONSULTING.CO.ZA
 WEBSITE: www.ktnconsulting.co.za



ROADS AND STRUCTURES
 DIRECTOR: ...
 ENGINEER: ...
 DATE: ...

DEPARTMENT OF PUBLIC WORKS
 PHYSICAL: ...
 COORNER RIVER AND BLAUBERG STREET
 LADANNA
 POLOKWANE

TEL NO 015 284 7400/1
 FAX/MAIL: NEWSROOM@DPW.LIMPOPO.GOV.ZA

DESIGNED BY: ...
 DRAWING CHECKED BY: ...
 DRAWING APPROVED BY: ...

LIMPOPO DEPARTMENT OF PUBLIC WORKS
 CONSTRUCTION OF FOUR (4) NEW LIBRARIES FOR THE LIMPOPO DEPARTMENT OF SPORT, ART AND CULTURE (DSCA).

PROJECT NO: 1400
 SCALE: ...
 DATE: SEPTEMBER 2021

PROJECT STATUS
 PROJECT NO: 1400
 SCALE: ...
 DATE: SEPTEMBER 2021

CALL REINFORCEMENT:
 X : VERTICAL 5.6 mm # 4'S
 Y : VERTICAL 5.6 mm # 4'S

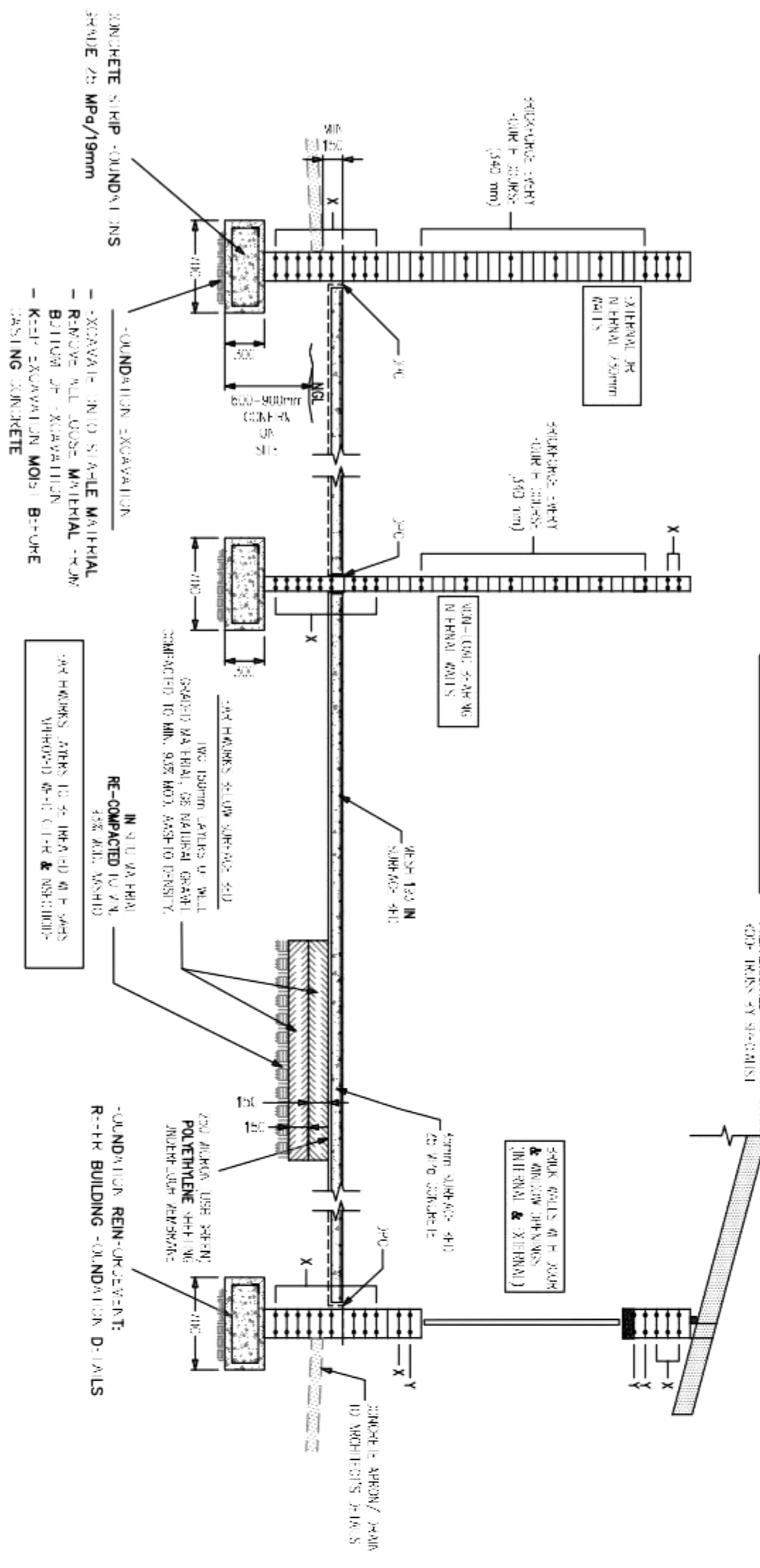

SCHEMATICAL BUILDING CROSS SECTION WITH SHIP FOUNDATION

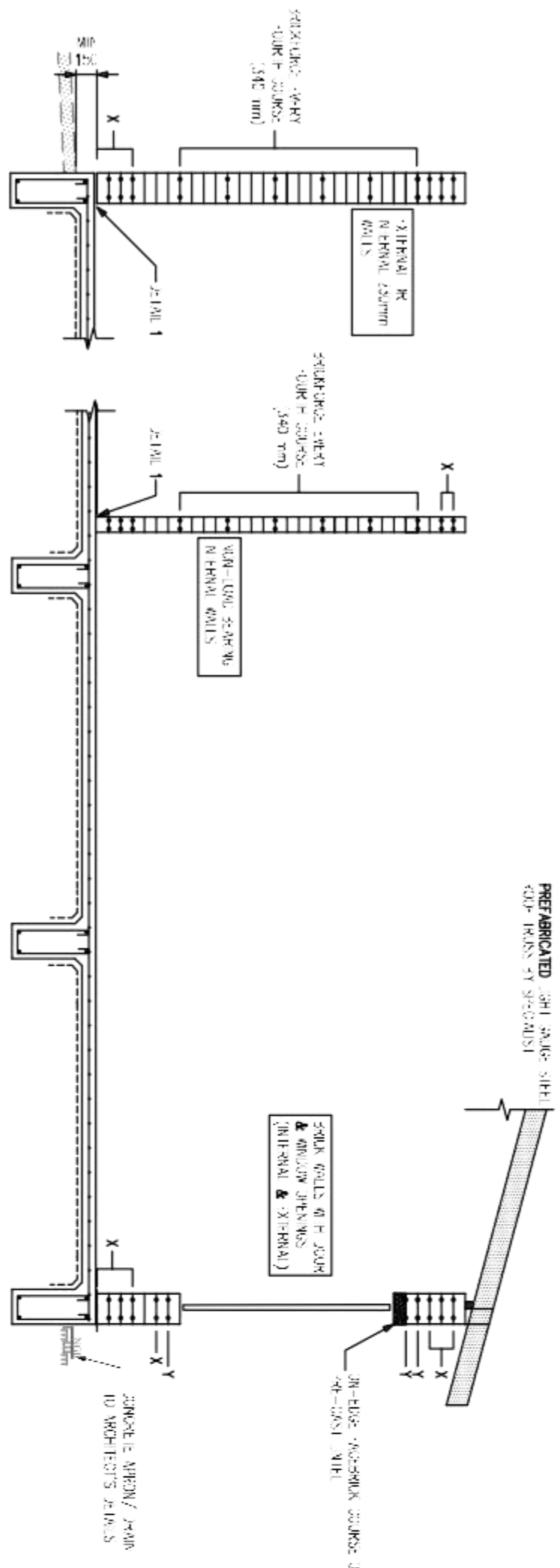

SCHEMATICAL BUILDING CROSS SECTION WITH RAFT FOUNDATION

NOTES FOR EXCAVATIONS & BRICKWORK:

1. CONCRETE
2. ALL WORK TO COMPLY WITH SANS 2001-PART ONE: CONCRETE WORKS
3. ALL WALLS - 100mm X 300mm
4. BRICKWORK - 200mm High
5. BRICKWORK SHALL BE OF THE LOOSER TYPE, COMPRISING TWO 200mm x 100mm BRICKS WITH ONE STRONG.
6. BRICKWORK SHALL BE REINFORCED WITH BRICKWORK EVERY FOURTH COURSE (300mm) FOR INTERNAL AND EXTERNAL WALLS.
7. ADDITIONAL WALL REINFORCEMENT:
8. SCHEDULED BRICKWORK (Masonry):
9. BRICKWORK SHALL BE REINFORCED WITH BRICKWORK EVERY FOURTH COURSE (300mm) FOR INTERNAL AND EXTERNAL WALLS.
10. BRICKWORK SHALL BE REINFORCED WITH BRICKWORK EVERY FOURTH COURSE (300mm) FOR INTERNAL AND EXTERNAL WALLS.
11. BRICKWORK SHALL BE REINFORCED WITH BRICKWORK EVERY FOURTH COURSE (300mm) FOR INTERNAL AND EXTERNAL WALLS.
12. BRICKWORK SHALL BE REINFORCED WITH BRICKWORK EVERY FOURTH COURSE (300mm) FOR INTERNAL AND EXTERNAL WALLS.
13. BRICKWORK SHALL BE REINFORCED WITH BRICKWORK EVERY FOURTH COURSE (300mm) FOR INTERNAL AND EXTERNAL WALLS.
14. BRICKWORK SHALL BE REINFORCED WITH BRICKWORK EVERY FOURTH COURSE (300mm) FOR INTERNAL AND EXTERNAL WALLS.
15. BRICKWORK SHALL BE REINFORCED WITH BRICKWORK EVERY FOURTH COURSE (300mm) FOR INTERNAL AND EXTERNAL WALLS.
16. BRICKWORK SHALL BE REINFORCED WITH BRICKWORK EVERY FOURTH COURSE (300mm) FOR INTERNAL AND EXTERNAL WALLS.
17. BRICKWORK SHALL BE REINFORCED WITH BRICKWORK EVERY FOURTH COURSE (300mm) FOR INTERNAL AND EXTERNAL WALLS.
18. BRICKWORK SHALL BE REINFORCED WITH BRICKWORK EVERY FOURTH COURSE (300mm) FOR INTERNAL AND EXTERNAL WALLS.
19. BRICKWORK SHALL BE REINFORCED WITH BRICKWORK EVERY FOURTH COURSE (300mm) FOR INTERNAL AND EXTERNAL WALLS.
20. BRICKWORK SHALL BE REINFORCED WITH BRICKWORK EVERY FOURTH COURSE (300mm) FOR INTERNAL AND EXTERNAL WALLS.
21. BRICKWORK SHALL BE REINFORCED WITH BRICKWORK EVERY FOURTH COURSE (300mm) FOR INTERNAL AND EXTERNAL WALLS.
22. BRICKWORK SHALL BE REINFORCED WITH BRICKWORK EVERY FOURTH COURSE (300mm) FOR INTERNAL AND EXTERNAL WALLS.
23. BRICKWORK SHALL BE REINFORCED WITH BRICKWORK EVERY FOURTH COURSE (300mm) FOR INTERNAL AND EXTERNAL WALLS.
24. BRICKWORK SHALL BE REINFORCED WITH BRICKWORK EVERY FOURTH COURSE (300mm) FOR INTERNAL AND EXTERNAL WALLS.
25. BRICKWORK SHALL BE REINFORCED WITH BRICKWORK EVERY FOURTH COURSE (300mm) FOR INTERNAL AND EXTERNAL WALLS.
26. BRICKWORK SHALL BE REINFORCED WITH BRICKWORK EVERY FOURTH COURSE (300mm) FOR INTERNAL AND EXTERNAL WALLS.
27. BRICKWORK SHALL BE REINFORCED WITH BRICKWORK EVERY FOURTH COURSE (300mm) FOR INTERNAL AND EXTERNAL WALLS.
28. BRICKWORK SHALL BE REINFORCED WITH BRICKWORK EVERY FOURTH COURSE (300mm) FOR INTERNAL AND EXTERNAL WALLS.
29. BRICKWORK SHALL BE REINFORCED WITH BRICKWORK EVERY FOURTH COURSE (300mm) FOR INTERNAL AND EXTERNAL WALLS.
30. BRICKWORK SHALL BE REINFORCED WITH BRICKWORK EVERY FOURTH COURSE (300mm) FOR INTERNAL AND EXTERNAL WALLS.
40. BRICKWORK SHALL BE REINFORCED WITH BRICKWORK EVERY FOURTH COURSE (300mm) FOR INTERNAL AND EXTERNAL WALLS.

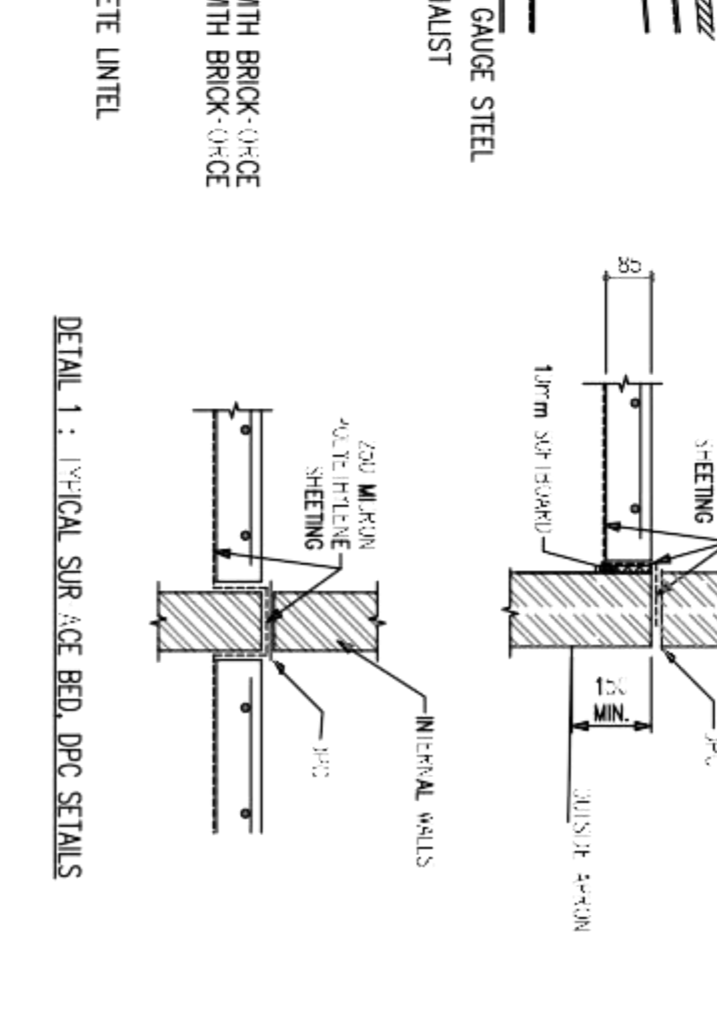
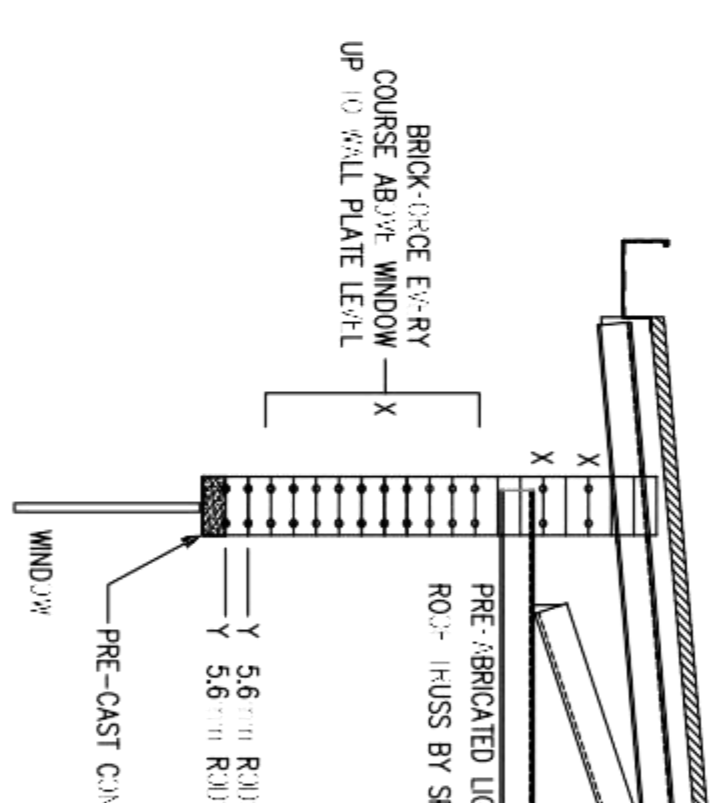
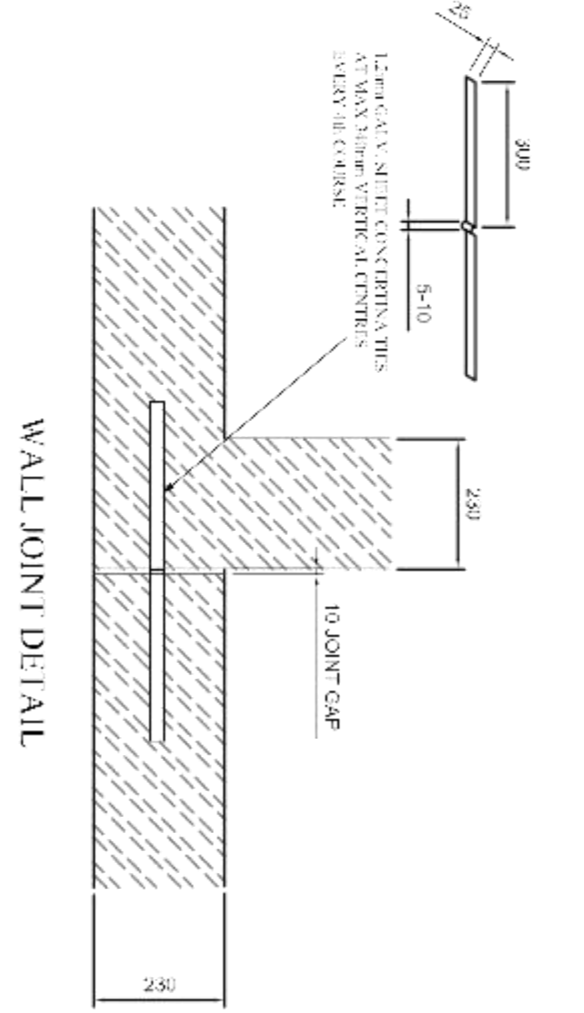
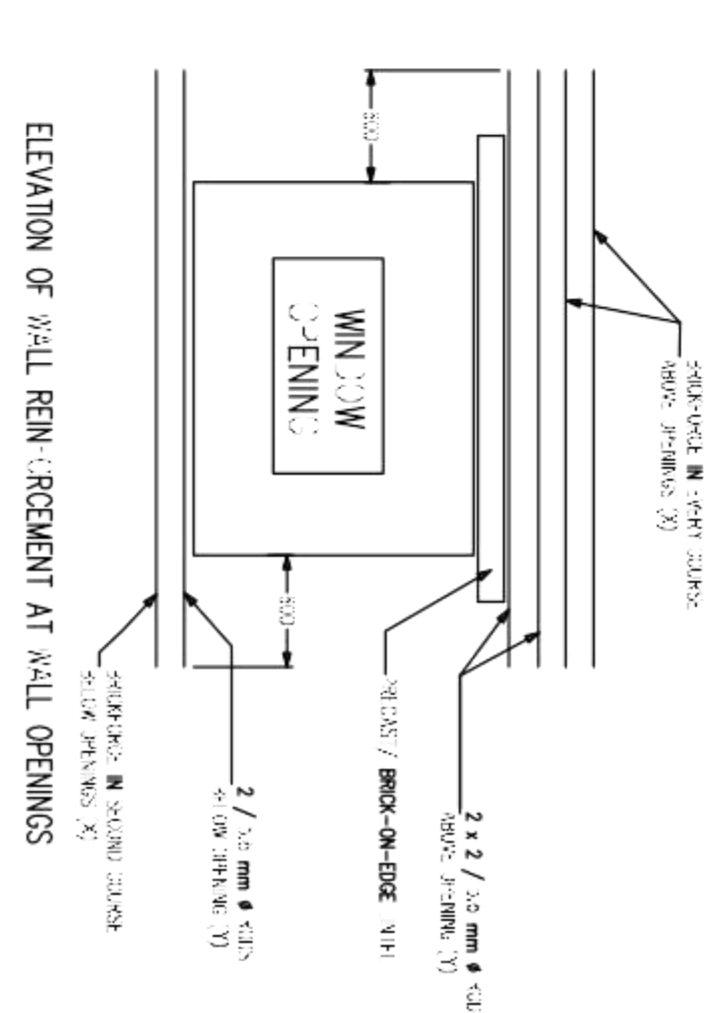

NO.	DATE	DESCRIPTION	ISSUED FOR	BY
A	2021-09-23	ISSUED FOR TENDER	ISSUED FOR TENDER	ISSUED FOR TENDER

CONSULTANT DETAILS
 KIN CONSULTING ENGINEERS AND PROJECT MANAGERS
 THORNHILL OFFICE PARK,
 BUILDING 27, SUITE F9
 52 BEKKER ROAD, MIDRAND.
 TEL NO.: +27 (0) 11 805 0981
 FAX NO.: +27 (0) 11 604 0039
 EMAIL: KTN@KTNCONSULTING.CO.ZA
 WEBSITE: www.ktnconsulting.co.za

ROADS AND STRUCTURES
 DIRECTOR: ...
 DEPARTMENT OF PUBLIC WORKS
 PHYSICAL: ...
 COHNER RIVER AND BLAUBERG STREET
 LAMANNIA
 POLOKWANE
 TEL NO.: 015 284 7400/1
 FAX/MAIL: NEWSROOM@DPW.LIMPOPO.GOV.ZA

NO.	DATE	DESCRIPTION	ISSUED FOR	BY
A	2021-09-23	ISSUED FOR TENDER	ISSUED FOR TENDER	ISSUED FOR TENDER

GENERAL STRUCTURAL BUILDING WORKS
 LIMPPO DEPARTMENT OF PUBLIC WORKS
 CONSTRUCTION OF FOUR (4) NEW LIBRARIES FOR THE LIMPPO DEPARTMENT OF SPORT, ART AND CULTURE (DSCA).

NO.	DATE	DESCRIPTION	ISSUED FOR	BY
A	2021-09-23	ISSUED FOR TENDER	ISSUED FOR TENDER	ISSUED FOR TENDER

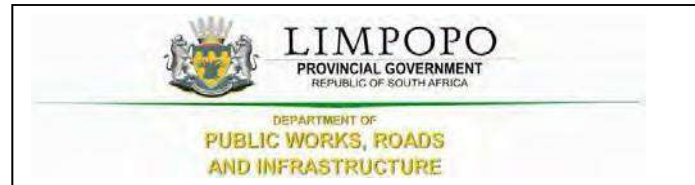

PART C7.2. 6: GEOTECHNICAL REPORT

FINAL NEAR SURFACE GEOTECHNICAL INVESTIGATION REPORT

FOR

**NEW LIBRARY FOR THE LIMPOPO DEPARTMENT OF ARTS AND
CULTURE IN VLEIFONTEIN, VHEMBE DISTRICT - LIMPOPO PROVINCE**

Report Number: GEO-08

Report Status: Final Report

July 2021

Prepared by:**DIGES GROUP**

Address: Suite No.1
Marshall Office Park
98 Marshall Street
Polokwane
0700

Contact Person: Luthada Olympus

Tel(w): 015 291 4151

Cell(P): 065 855 5378

Email: olympus@diges.co.za

Prepared for:**Department of Public Works, Roads & Infrastructure**

Address: 43 Church Street
Polokwane
0699

Contact Person: T Maswanganyi
Tel (w): 015 284 7001

Email: maswanganyiTB@dpw.limpopo.gov.za



LIMPOPO
PROVINCIAL GOVERNMENT
REPUBLIC OF SOUTH AFRICA

DEPARTMENT OF
PUBLIC WORKS, ROADS & INFRASTRUCTURE

Table Contents

1. INTRODUCTION.....	3
1.1 DATABASE.....	3
1.2 OBJECTIVES OF THE STUDY	3
2. FACTUAL REPORT.....	4
2.1 DESKTOP STUDIES	4
2.2 SITE DESCRIPTION.....	4
2.3 TOPOGRAPHICAL DESCRIPTION.....	4
2.4 GEOLOGICAL DESCRIPTION	4
2.5 CLIMATE AND HYDRO-GEOLOGICAL DESCRIPTION	5
2.6 FIELD WORK – NEAR-SURFACE GEOTECHNICAL INVESTIGATION.....	5
2.7 OBSERVATIONS.....	5
2.8 LABORATORY RESULTS	6
3.0. INTERPRETATIVE REPORT	8
3.1. DISCUSSION OF RESULTS – TEST PITS.....	8
3.1.1. <i>Transported Soil</i>	8
3.1.2. <i>Pebble Marker</i>	8
3.1.3. <i>Residual Gneiss</i>	9
3.2. GEOTECHNICAL MAPPING OF THE SITE	9
3.3. FOUNDATION RECOMMENDATIONS (LIGHT TO MEDIUM LOADED STRUCTURES).....	10
3.3.1. <i>Soil Engineered Mattress</i>	10
3.3.2. <i>Reinforced Concrete Raft</i>	10
3.4. ROADS AND TERRACES.....	10
3.4.1. <i>Road Designs on Collapsible Soils</i>	11
3.5. EXCAVATION CLASSIFICATION	11
3.6. STORMWATER MANAGEMENT	12
3.7. GENERAL.....	12
4.0. CONSTRUCTION MONITORING	13
4.1. EXCAVATION INSPECTION.....	13
4.2. CONTROL TESTING.....	13
REFERENCE	14

APPENDICES

Appendix A: Site Plan

Appendix B: Topographical Map

Appendix C: Geological Map

Appendix D: Soil Profiles

Appendix E: Near Surface Geotech - Site Photographs

Appendix F: Laboratory Results and DCP Test Results

1. INTRODUCTION

Quote and proposal document were submitted to the Department of Public Works, for a near geotechnical investigation to be conducted in Vleifontein and Tshaulu Libraries within the Limpopo Province. The near geotechnical investigation is required to help with the foundation design of the proposed structures.

The proposed new library will be a single storey structure and comprises of the following:

- Hall, foyer, waiting area and reception
- Female and Male ablutions
- Storeroom, Computer room and serve room
- Book space, study area and office
- Kitchen, workroom, and children room

The work was undertaken in accordance with the National Department of Housing Geotechnical Site Investigations for Housing Developments Generic Specification GFSH-2 September 2002.

The geotechnical investigation is required for planning and design purposes.

1.1 DATABASE

- Site Development Plan was provided by Department of Public Works - Limpopo.

1.2 OBJECTIVES OF THE STUDY

The objectives of the investigation were to complete a near surface geotechnical investigation that would provide sufficient geotechnical data for the detailed design of the proposed development and would:

- Identify the soil profile to a depth of approximately 3.0m or refusal of a TLB machine.
- Determine the engineering parameters of the near surface soils.
- Conduct Hand Dynamic Cone Penetrometer.
- Recommend site specific foundations for the structures.
- Allocate Residential Site Class Designations, according to the NHBRC.
- Assess the suitability of the near surface soils for use in earthworks and road pavement layers.
- Comment on any geotechnical problems that may impact upon the construction.

2. FACTUAL REPORT

2.1 DESKTOP STUDIES

Prior to the commencement of any field work, a desktop study was conducted on the data obtained from previous investigations by other consultants.

The 1:250 000 geological map, “2328 Pietersburg” was consulted to determine the regional and local geology. In order to supply information regarding the topography of the site, the 1:50 000 topographical map, “No 2329 BB Louis Trichardt” was referenced.

2.2 SITE DESCRIPTION

The site is in Vleifontein Village, Vhembe District within the Limpopo province and is approximately 1.44Ha in extent, located within these four corner coordinates A =29 Y-101323 X2569284, B = 29 Y-101235 X2569339, C = 29 Y-101330 X2569528, D = 29 Y-101360 X2569523.

The site is situated approximately 12km away from the Elim CBD, and about 20km away from the N1 national Road. The site is situated adjacent to Tshiwelo Primary School. The proposed site is currently undeveloped and can be accessed via an unnamed road from the road connecting Elim and the N1 national route.

At the time of investigation, the was covered by natural veld grass and shrubs, indigenous, small to medium trees.

The location of the site is indicated on the Google site plan attached as appendix A and a series of photographs showing the property and trial holes are included as appendix F.

2.3 TOPOGRAPHICAL DESCRIPTION

From a desktop review of the topographical map, ““No 2329 BB Louis Trichardt” as well as observations made during the site investigation, it is evident that the site occurs at elevations ranging between 1062m (amsl) on the North and 1073m (amsl) on the South.

The site slopes gently towards the North and North West at an average slope of 5.2% and 1.97% respectively.

Surface runoff, particularly during periods of heavy or prolonged rainfall is expected to be in the form of sheetwash towards the North and North West.

2.4 GEOLOGICAL DESCRIPTION

From desktop review of the 1:250 000 geological series map, 2328 Pietersburg, it is evident that the site is underlain by gneiss of the Goudplaats Gneiss basement.

Observation made on site suggest that the residual gneiss has recently been blanketed by transported soils. The residual gneiss was distinguished by a pebble marker which was immediately below the transported soils, although not observed in all trial holes.

An extract from “2328 Pietersburg” geological map of the area is included as appendix C of this report.

2.5 CLIMATE AND HYDRO-GEOLOGICAL DESCRIPTION

The region receives between 560mm and 755mm of rainfall per year, most of which occur as heavy, isolated thunder showers between October and March.

Surface runoff, particularly during periods of heavy or prolonged rainfall is expected to be in the form of sheetwash towards the North and North West.

Various climatic environments influence the weathering of bedrocks and residual soil development is best represented by Weinert's climatic N-value, and thus the climatic regime plays a fundamental role in the development of the soil profile and the weathering of rock.

Weinert (1964) demonstrated that chemical decomposition is the predominant mode of rock weathering in areas where the climatic "N-value" is less than 5. In areas where the climatic N-value is between 5 and 10, disintegration is the predominant form of weathering, although some chemical decomposition of the primary rock minerals still takes place. Where the climatic N-value is greater than 10, secondary minerals do not develop to an appreciable extent and all weathering takes place by mechanical disintegration of the rock.

Weinert's climatic N-value for the site is less than 5, and thus this implies that decomposition is the predominant form of weathering.

No water strikes were observed in any trial holes.

2.6 FIELD WORK – NEAR-SURFACE GEOTECHNICAL INVESTIGATION

On the 31st of May 2021, field investigation was conducted where 4 (four) trial holes were excavated within the perimeter of the site using a TLB "JCB" to a depth of 3m or refusal. 4 (four) Hand Dynamic Cone Penetrometer (DCP) were advanced next to each trial hole position to correlate consistency of soils and determine bearing capacity.

The trial hole positions were set out in the field by the Diges group's engineering geologist to provide a spread of information and were co-ordinated using a hand-held GPS.

The following samples were deemed necessary to be taken for laboratory testing: -

Foundation Indicator	3
CBR Tests	2
Collapse Potential	1

Each trial holes "deemed" safe to enter was internally profiled by an engineering geologist according to the "Guidelines for soil and rock logging in South Africa", sampled as necessary and then loosely backfilled. The site plan which appears in appendix A indicates the trial hole positions.

2.7 OBSERVATIONS

While the nature of the soils encountered in the test pits is relatively uniform in terms of the type of material, there is a reasonable degree of variation in the thicknesses of the various horizons. Table 1 gives the test pit depth and whether or not there was water seepage encountered in the trial holes.

Table 1 – Test Pit Depths

TP No.	Depth of Hole (m)	Nature of Material at Base of Pit	Water Seepage
1	No Refusal of TLB @ 3.0m	Hillwash	No Water Seepage
2	No Refusal of TLB @ 3.0m	Residual Gneiss	No Water Seepage
3	No Refusal of TLB @ 3.0m	Residual Gneiss	No Water Seepage
4	No Refusal of TLB @ 3.0m	Residual Gneiss	No Water Seepage

Table 2 gives the maximum, minimum and average depths to the top of the major horizons and their thicknesses.

Table 2 - Soil Horizon Data

Material Type	Depth to top of the soil horizon			Soil Horizon Thickness		
	Min(m)	Max(m)	Avg(m)	Min(m)	Max(m)	Avg(m)
Hillwash	0.00	0.00	0.00	0.60	3.0	1.65
Pebble Marker	0.70	0.70	0.70	0.20	0.20	0.20
Residual Gneiss	0.60	2.30	1.27	0.70	>2.4	>1.73

2.8 LABORATORY RESULTS

A summary of the laboratory test results is given in table 3, 4, 5 and 6 while the detailed results are included in appendix G of the report.

For more accurate determination and classification purposes, particle size distribution and Atterberg Limits tests were carried out on representative samples of the various soil horizons present below the site. The results are summarised in Table 3 below: -

Table 3 – Summary of Indicator Test Results

TP No	Depth (m)	Material	PI (%)	Relative Density (SANS 5844)	GM	Activity
TP02	0.0 - 2.30	Silty Sandy Clay: Transported soils	12	2.707	0.30	Low
TP03	0.60 – 3.0	Silty Sandy Gravel: Residual Gneiss	10	2.819	2.01	Low
TP04	0.0 – 0.70	Silty Sandy Clay: Transported soils	15	2.810	0.34	Low

Table 4: Moisture Density Relationship and Relative Density

TP No	Depth (m)	Material	Optimum Moisture Content (%)	Maximum Dry Density (kg/m ³)	Relative Density of Soils
TP02	0.0 – 2.30	Transported soils	21.8	1622	2.707
TP04	0.0 – 0.70	Transported soils	19.7	1656	2.810

Table 5 – Summary of Laboratory Test Results – (Roads & Earthworks)

TP No.	Depth (m)	Material	PI (%)	GM	CBR Value @ % Mod AASHTO				COLTO Class
					90%	93%	95%	100%	
TP02	0.0 – 2.30	Transported soils	12	0.30	7	9	10	15	>G9
TP04	0.0 – 0.70	Transported soils	15	0.34	7	7	8	8	>G9

Table 6: Collapse Potential Test Results

TP No.	Depth (m)	Material	Moisture Content (%)	Void Ratio	Collapse Potential (%)
1	0.70 – 0.90	Transported soils	6.0	0.793	8.8

3.0. INTERPRETATIVE REPORT

3.1. DISCUSSION OF RESULTS – TEST PITS

3.1.1. TRANSPORTED SOIL

The transported material was observed in all trial pits across the site from surface to a maximum depth of 3m and has an average thickness of 1.65m. This horizon has been depicted as a slightly moist, reddish brown, general consistency of firm, silty sandy clay and open textured structure.

Foundation indicator test results indicate that the transported horizon exhibit a low plasticity nature, with plasticity index of between 12% and 15%. This material is regarded as fine grained in texture with a grading modulus of between 0.30 and 0.34.

CBR Test results indicate that this material classifies as >G9 in terms of COLTO classification and can be utilised as a subgrade in terms of pavement material classes.

Collapse potential tests carried out on these soils indicated that they have a collapse potential of 8.8%. According to research carried out by Jennings and Knight et al (see table 7 below), these materials can be regarded as being "Trouble" with regards the collapse potential. The table below categorizes the severity of damage that may occur to masonry structures, conventionally founded in material which exhibits a collapse potential.

Table 7: Collapse Potential vs Damage Potential	
Collapse potential (%)	Severity of Problem
0 - 1	No Trouble
1 - 5	Moderate Trouble
5 – 10	Trouble
10 - 20	Severe Trouble
>20	Very Severe Trouble

It is our opinion that due to the collapsible nature of these soils; this horizon should not be considered as a viable founding medium for any of the proposed structures in its current state.

This horizon has a presumed bearing capacity of between 75kPa and 150kpa correlated with the general consistency of firm in all trial holes where it was encountered based on BS 8004:1986. The Dcp test results for this horizon suggest a bearing capacity of between 75kPa and 200kpa.

3.1.2. PEBBLE MARKER

This horizon has been described as slightly moist, reddish brown, silty sandy gravel, with a general consistency of loose, and it was Pebble marker in nature. This horizon forms the demarcation between the transported soils which overlie it, and the residual soils which underlie it.

This material was only intercepted in TP4 at a depth of 700m below current ground level, and with a thickness of 200mm.

No laboratory testing was conducted in this horizon.

It is our opinion that this horizon should be considered as a founding medium, due to its sporadic occurrence and poor consistency.

This horizon has a presumed bearing capacity of less than 75kpa correlated with the general consistency of loose where it was presence based on BS 8004:1986.

3.1.3. RESIDUAL GNEISS

This horizon has been described as slightly moist, reddish brown blotched purple and orange/ orangish brown, silty sand as matrix for gravels at the bottom with a general consistency of medium dense.

This material was intercepted from a minimum depth of 600mm to a maximum depth of 2.3m below current ground level. The thickness of the horizon was found to be ranging from 700mm to 2.41m (average 1.73m).

Foundation indicator test results indicate that the transported horizon exhibit a low plasticity nature, with plasticity index of 10%. This material is regarded as coarse grained in texture with a grading modulus of 2.01.

This horizon has a presumed bearing capacity of between 100kPa and 200kPa correlated with the general consistency of medium dense based on BS 8004:1986.

The results of the DCP testing should be treated with caution especially for the gravelly soils, which can indicate apparent high estimated bearing capacity values due to slow penetration. The slow penetration rate can be attributed to the scattered gravels of the decomposing parent rock hence the derived bearing capacity values can be misleading and should be treated with caution during design.

3.2. GEOTECHNICAL MAPPING OF THE SITE

In order to map the geotechnical characteristics of the underlying soils, the classification method proposed by The Joint Structural Division of SAICE, and IstructE The Code of Practise entitled "Foundations and Superstructures for Single Storey Residential Buildings of Masonry Construction" as described in table 8 below.

Table 8: Site Specific Residential site class designations				
Typical Founding Material	Character of Founding Material	Expected Range of Total Soil Movements (Mm)	Assumed Differential Movement (% of Total)	Site Class
Fine grained soils with moderate to very high plasticity (clays, silty clays, clayey silts and sandy clays)	EXPANSIVE SOILS	<7,5	50%	H
		7,5-15	50%	H1
		15-30	50%	H2
		>30	50%	H3
Silty sands, sands, sandy and gravelly soils	COMPRESSIBLE AND POTENTIALLY COLLAPSIBLE SOILS	<5,0	75%	C
		5,0-10	75%	C1
		>10	75%	C2

Based on the visual inspection of the soil horizons made during the site investigation and Laboratory Test results, the site classifies as C2/H1

3.3. FOUNDATION RECOMMENDATIONS (LIGHT TO MEDIUM LOADED STRUCTURES)

It is evident that the transported soils underlying the site have exhibit a “Trouble” collapse potential, and It is therefore our opinion that these soils are not suitable for a conventionally founded and settlement sensitive structures.

3.3.1. SOIL ENGINEERED MATTRESS

It is our opinion that the proposed structure should be founded on an engineered soil mattress constructed as follows: -

- An area at least 1m larger than the footprint of the structure, will need to be excavated to a depth of at least 1.2m multiple by width of the foundation.
- Once the bulk excavation is completed, rip and recompact 150mm at the base of the excavation to 90% Mod AASHTO.
- Import a minimum of G7 standard material quality which should then be placed in 150mm layers and compacted to 93% Mod AASHTO.
- The two layers which will be immediately below any proposed new foundations are to be compacted to 95% Mod AASHTO.
- Backfill to final Terrace level in 150mm layers to 90% Mod AASHTO.
- Foundations for structures, should then be excavated back into the fill, to the minimum depth compatible with the provision of services into the building i.e., not more than 600mm below finished terrace level.
- An allowable bearing capacity for foundations whose maximum width does not exceed 750mm would then be 150kPa. Normally loaded floor slabs can then be supported on the final fill terrace.

3.3.2. REINFORCED CONCRETE RAFT

Alternatively, lightly loaded structures can be founded on a Reinforced Concrete Raft (RCR) designed by a specialist structural engineer. The raft should be placed on at least 300mm of G7 or better material compacted to 95% Mod AASHTO, where a minimum allowable bearing capacity of 150kPa can be achieved.

3.4. ROADS AND TERRACES

Visual assessment and laboratory testing results suggest that the hillwash (transported) soils are suitable for use as an insitu subgrade in road pavement layer works, and thus the following should be incorporated into the pavement design.

- Remove the transported soil horizon to a maximum depth of 400mm and import 150mm G8 material to use as a subgrade layer, and compact to 93% Mod AASHTO.
- Import 150mm thick layer of G6 standard material to be utilised as subbase compact to 95% of Mod. AASHTO density.
- Thickness of 25mm compacted sand bedding layer must then be placed on top of the compacted G6 quality material. It is important to note the edge restraints must be installed before laying of blocks commences to prevent migration of the paving blocks by construction traffic.

It's of our opinion that precast concrete kerb or a premix infill would be adequate to prevent the movement of blocks and loss of performance. Measures must be put in place to prevent the pavements from being subjected to saturation from sub-surface water or surface water ponding and infiltration of water into the layer works.

It is also important to ensure that the paving is laid slightly higher (i.e., 5 - 10 mm higher than) stormwater structures or channels. Where a high-water table exists, subsoil drainage should be installed.

Table 9 below suggests minimum material qualities for various road pavement layers

Table 9 : Pavement Material Classes			
Layer	TRH 14 Material Class (natural gravels)	Thickness (mm)	Required Compaction
Surface	Interlocked Cemented Pavers	60	N/A
Subbase	G6	150	95% MDD
Subgrade	G8	150	93% MDD

3.4.1. ROAD DESIGNS ON COLLAPSIBLE SOILS

Roads can be severely affected by collapsible soils and therefore it is important to adopt the appropriate design methodology and, precautionary measures that should be undertaken to surface and subsurface drainage along the road to minimize possible entry of water into the road foundation, and specific attention is also required where drainage structures cross underneath the road to prevent ponding of water.

No large trees should be allowed to grow inside the road reserve.

3.5. EXCAVATION CLASSIFICATION

In terms of SABS 1200D:1988 Earthworks, excavations to depths presented in table 10 below are likely to classify as "Soft".

Table 10: Soft Excavation Data (SANS 1200 D)	
Area	Excavation depths (m)
Site Classification C2/H1	up to 3.0

Below these depths, Gneiss bedrock is likely to be intercepted and a classification of "intermediate" grading to "hardrock" can be anticipated.

It is recommended that the sides of any excavations deeper than 1.5m should be sloped to 1:1.5, to ensure sufficient slope stability to prevent collapse of the sidewalls. During periods of heavy rainfall however, the

sides of the excavations should be regularly examined, to ensure the safety of the excavation for personnel and equipment working in them.

3.6. STORMWATER MANAGEMENT

It is assumed that all services on the site will be connected into those already present in the area and it is likely that most of the runoff, particularly during periods of heavy or prolonged rainfall is expected to be in the form of sheetwash towards the North and North West.

Precautions must be implemented to prevent damp problems in the proposed structures.

3.7. GENERAL

Although every effort has been made to ensure the accuracy of the information contained in this report, the results are based upon fieldwork. It is thus possible that localised soil conditions at variance to those described in the report may be encountered. It is recommended that the foundation excavations for each structure be inspected by a competent person during construction in order to verify that the materials thus exposed are not at variance with those described in the report and that it meets design criteria.

As indicated in section 2.7, all test pits were loosely backfilled upon completion of the fieldwork. In order to avoid the possibility of localised settlement occurring below structures and or internal roads due to the consolidation settlement of this loose backfill, it is recommended that each test hole be identified and adequately backfilled in 150mm layers, to at least 90% Mod AASHTO.

In order to avoid the potential of differential settlement, it is recommended that foundations for individual structures should not be placed in or on differing founding materials.

4.0. CONSTRUCTION MONITORING

4.1. EXCAVATION INSPECTION

It is recommended that all foundations be inspected by a competent person, prior to placing any concrete.

4.2. CONTROL TESTING

Regular checks on the quality and compaction of the backfill to the terraces should be made.

Yours Faithfully for: Diges Group

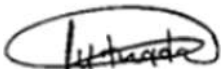

Compiled By: -

Luthada Olympus (Pr.Sc. Nat)- 122601

Engineering Geologist



Reviewed By: -

Nekhaguma Mpho (Pr.Sc. Nat)- 400526/14

Senior Engineering Geologist

REFERENCE

- Jennings JE et al. "Revised Guide to Soil profiling for Civil Engineering Purposes in Southern Africa" - Civil Engineer in South Africa, January 1973
- Van der Merwe DH. "The prediction of heave from the Plasticity Index and percentage clay fraction of soils" Civil Engineer in South Africa Vol 6, 1964
 - TRH 14, "Guidelines for Road Construction Materials" - NITRR, 1985
- Jennings, J and Knight, K. (1975). A guide to construction on or with materials exhibiting additional settlement due to "collapse" of grain structure. Proceedings of the Sixth Regional Conference on Soil Mechanics and Foundation Engineering. Durban
 - SANS 1936 Parts 1, 2 and 3: 2012 Development of Dolomitic Land
- Proposed method for dolomite land hazard risk assessment in South Africa. Buttrick, Van Schalkwyk, Kleywegt, and Watermeyer. Journal of South African Institution of Civil Engineering 43(2) and 44(3).2001
- The method of scenario supposition for stability evaluation of sites on dolomitic land in South Africa. Buttrick and Van Schalkwyk. 1995
- Application of the method of scenario supposition risk evaluation technique for the assessment of the stability of sites underlain by dolomite in South Africa. Calitz. 1995
 - Problems of soils in South Africa - State of the Art - Dolomite. Wagener. 1985
 - Construction methods on dolomitic land. Van der Berg. 1996
- Watermeyer RB, Buttrick DB, Trollip NYG, Gerber AA, Pieterse N (2008) A performance-based approach to the development of dolomite land"

APPENDIX A

SITE LOCALITY AND TEST PIT LOCATIONS AT VLEIFONTEIN LIBRARY



LIMPOPO
PROVINCIAL GOVERNMENT
REPUBLIC OF SOUTH AFRICA

DEPARTMENT OF
PUBLIC WORKS, ROADS & INFRASTRUCTURE

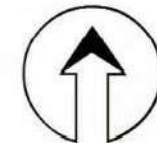
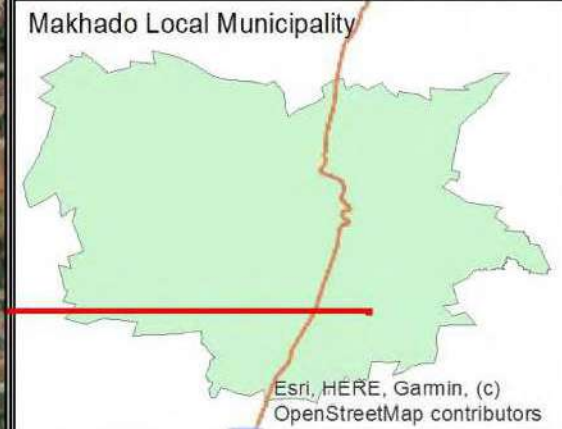

Legend

- Test Pits
- Site Boundary

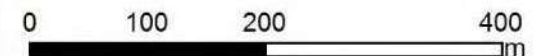

Suite 1, Marshal Office Park
98 Marshal Street
Polokwane
0700

Esri, HERE, Garmin, (c) OpenStreetMap contributors, Esri, HERE, Garmin, (c) OpenStreetMap contributors, and the GIS user community; Source: Esri, DigitalGlobe, GeoEye, Earthstar Geographics, CNES/Airbus DS, USDA, USGS, AeroGRID, IGN, and the GIS User Community

Projection: Geo Datum WGS84, EPSG WKID:4326
Source: Esri Earth, DIGES
Date: July 2021

SITE LOCALITY AND DCP LOCATIONS AT VLEIFONTEIN LIBRARY



LIMPOPO
PROVINCIAL GOVERNMENT
REPUBLIC OF SOUTH AFRICA

DEPARTMENT OF
PUBLIC WORKS, ROADS & INFRASTRUCTURE

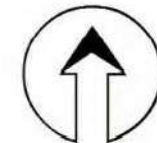

Legend

- DCP Positions
- Site Boundary



Suite 1, Marshal Office Park
98 Marshal Street
Polokwane
0700

Esri, HERE, Garmin, (c) OpenStreetMap contributors, Esri, HERE, Garmin, (c) OpenStreetMap contributors, and the GIS user community; Source: Esri, DigitalGlobe, GeoEye, Earthstar Geographics, CNES/Airbus DS, USDA, USGS, AeroGRID, IGN, and the GIS User Community

Projection: Geo Datum WGS84, EPSG WKID:4326
Source: Esri Earth, DIGES
Date: July 2021

APPENDIX B

**SITE LOCALITY AND TEST PIT LOCATIONS
AT VLEIFONTEIN LIBRARY**



LIMPOPO
PROVINCIAL GOVERNMENT
REPUBLIC OF SOUTH AFRICA

DEPARTMENT OF
PUBLIC WORKS, ROADS & INFRASTRUCTURE



Est.1, HERE, Garmin, (c)
OpenStreetMap contributors;
Est.1, HERE, Garmin, (c)
OpenStreetMap contributors,

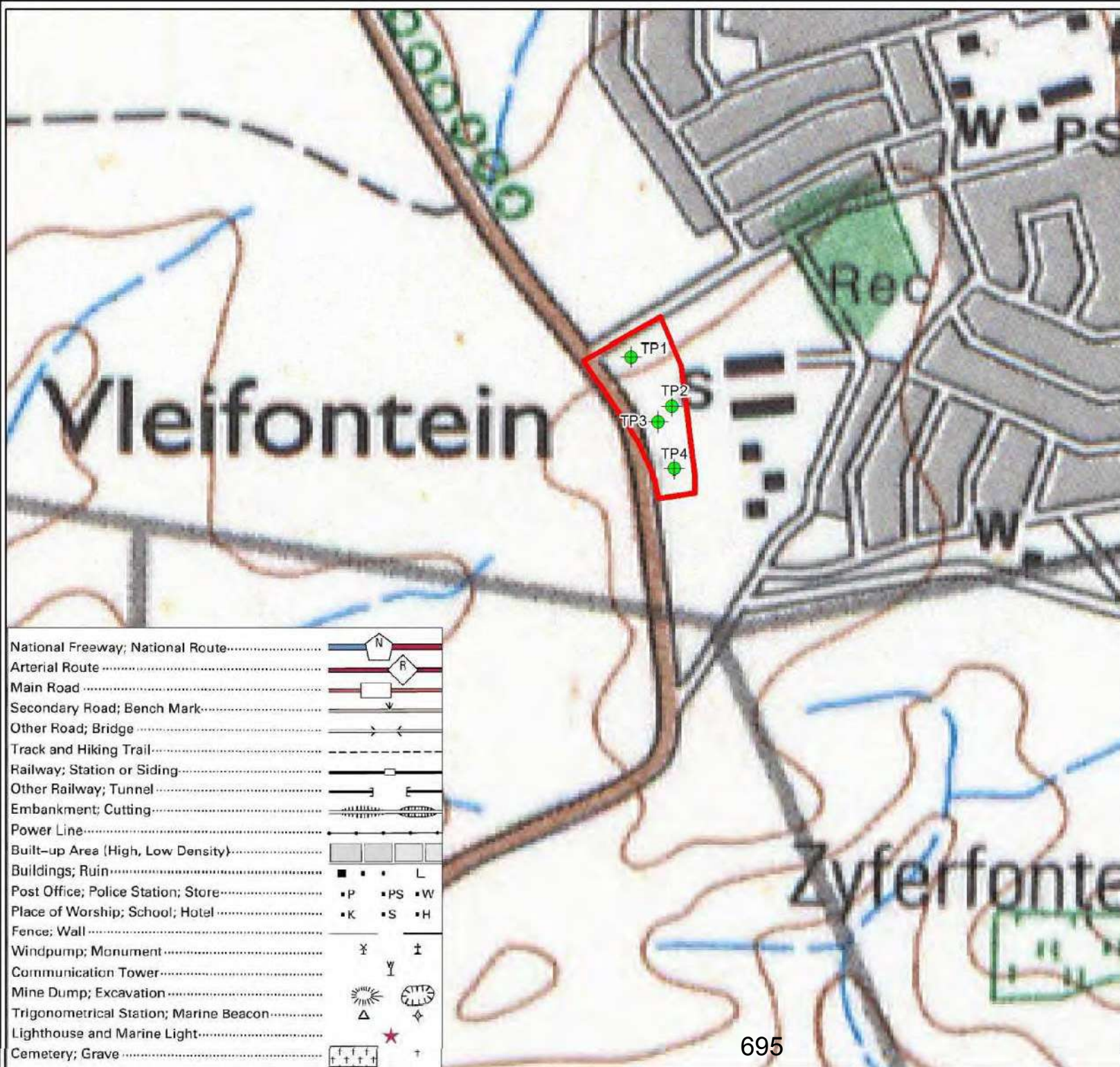

National Freeway; National Route	
Arterial Route	
Main Road	
Secondary Road; Bench Mark	
Other Road; Bridge	
Track and Hiking Trail	
Railway; Station or Siding	
Other Railway; Tunnel	
Embankment; Cutting	
Power Line	
Built-up Area (High, Low Density)	
Buildings; Ruin	
Post Office; Police Station; Store	
Place of Worship; School; Hotel	
Fence; Wall	
Windpump; Monument	
Communication Tower	
Mine Dump; Excavation	
Trigonometrical Station; Marine Beacon	
Lighthouse and Marine Light	
Cemetery; Grave	

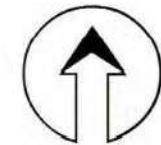

Legend

- Test Pits
- Site Boundary



Suite 1, Marshal Office Park
98 Marshal Street
Polokwane
0700

Projection: Geo Datum WGS84, EPSG WKID:4326
Source: NGI 2329BB, DIGES
Date: July 2021

APPENDIX C

GEOLOGY AT VLEIFONTEIN LIBRARY SITE



DEPARTMENT OF
PUBLIC WORKS, ROADS & INFRASTRUCTURE

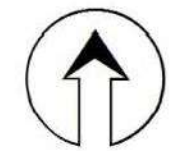
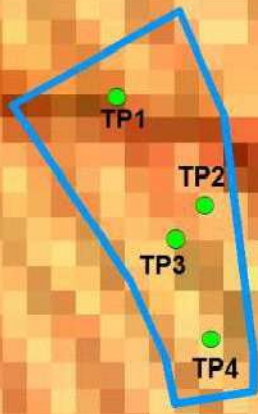
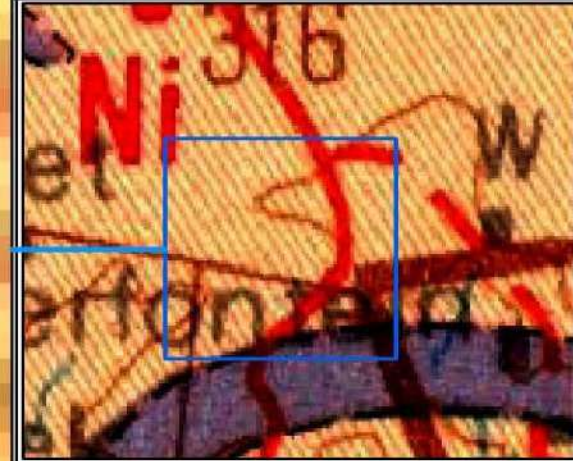

Legend

- Test Pits
- Site Boundary

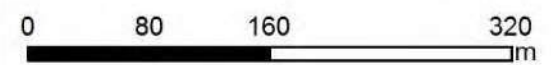

DIGES GROUP Suite 1, Marshal Office Park
98 Marshal Street
Polokwane
0700

Projection: Geo Datum WGS84, EPSG WKID:4326
Source: CGS, DIGES
Date: July 2021

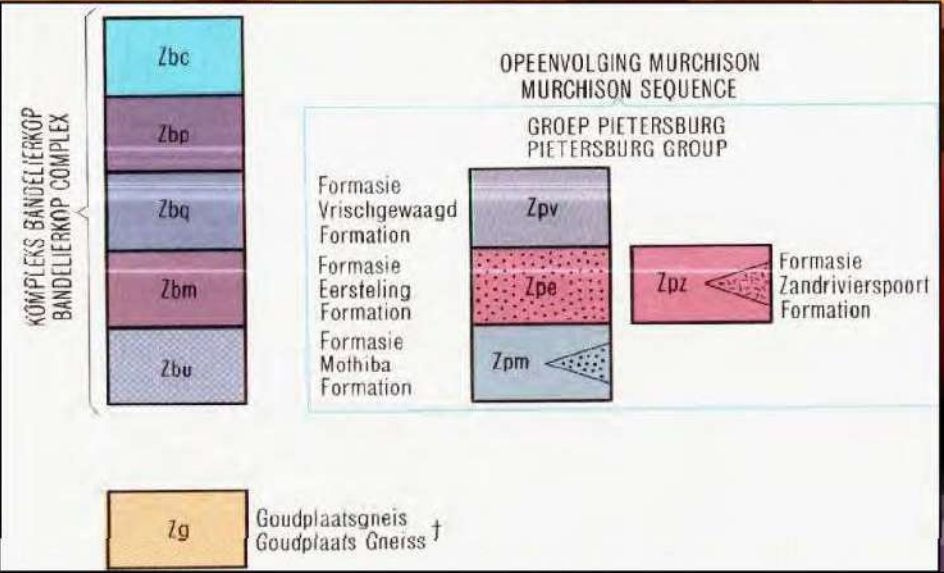

APPENDIX D

Scale
1:25

0.00

Slightly moist, Reddish brown, firm, intact, silty sandy clay: Transported soils.



3.00

NOTES

- 1) No Refusal of TLB @ 3.0m
- 2) No water seepage observed
- 3) CP @ 0.70 - 0.90m

CONTRACTOR :
MACHINE :
DRILLED BY :
PROFILED BY : Luthada O
TYPE SET BY : Luthada O
SETUP FILE : STANDARD.SET

INCLINATION : Vertical
DIAM :
DATE : 31/05/2021
DATE : 31/05/2021
DATE : 08/07/2021 05:43
TEXT : ..oilProfiles\Profiles.txt

ELEVATION :
X-COORD :
Y-COORD :

HOLE No: TP1

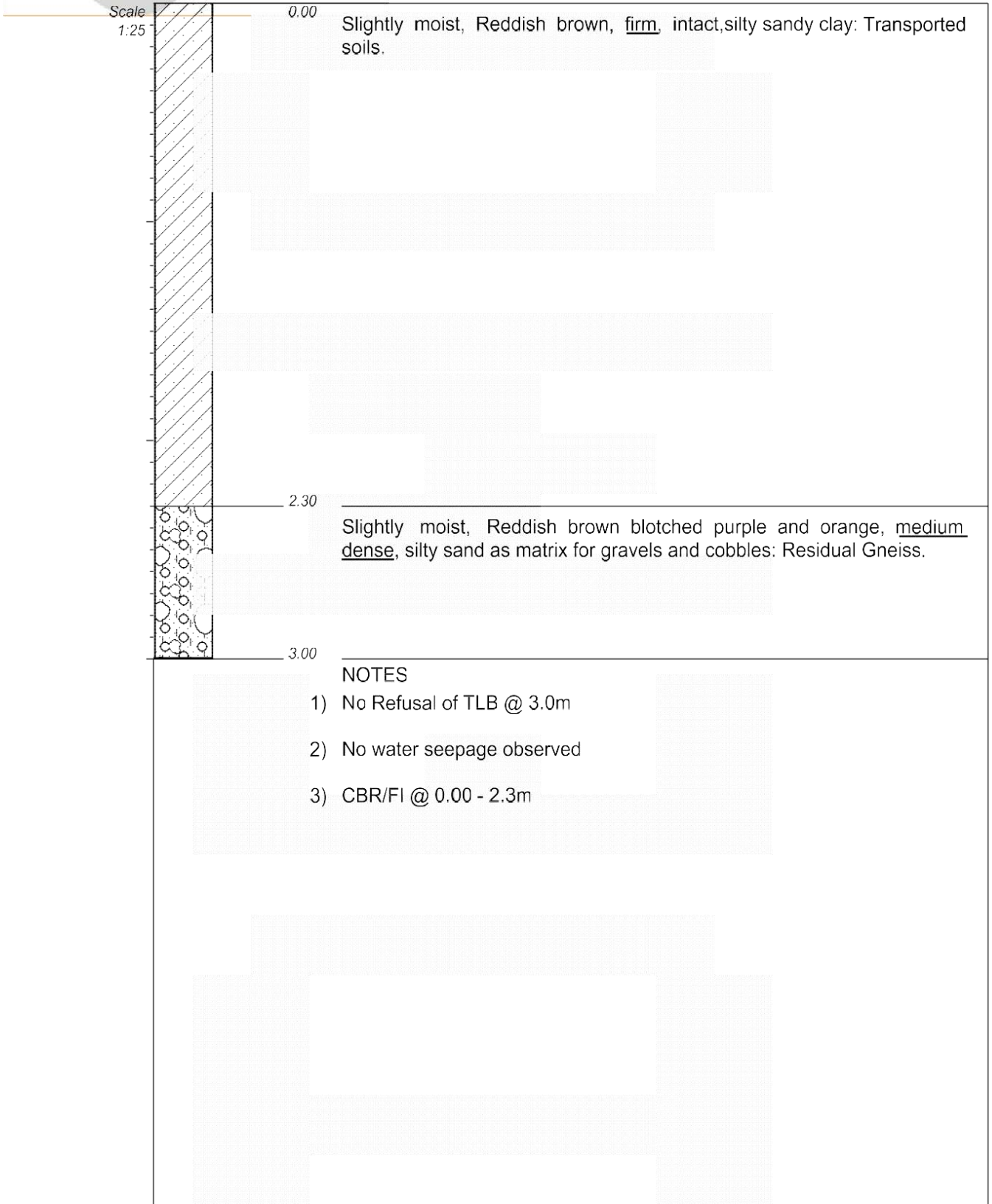

CONTRACTOR :
MACHINE :
DRILLED BY :
PROFILED BY : Luthada O
TYPE SET BY : Luthada O
SETUP FILE : STANDARD.SET

INCLINATION :
DIAM :
DATE : 31/05/2021
DATE : 31/05/2021
DATE : 08/07/2021 05:43
TEXT : ..oilProfiles\Profiles.txt

ELEVATION :
X-COORD :
Y-COORD :

HOLE No: TP2

Scale
1:25



0.00

Slightly moist, Reddish brown, firm, silty sandy clay and abundant of fine to medium roots: Transported soils.

0.60

Slightly moist, Orangish brown mottled reddish, Medium dense with pockets of dense, silty sand as matrix for gravels and cobbles: Residual Gneiss.

3.00

NOTES

- 1) No Refusal of TLB @ 3.0m
- 2) NO Water seepage observed
- 3) FI @ 0.60 - 3.0m

CONTRACTOR :
MACHINE :
DRILLED BY :
PROFILED BY : Luthada O
TYPE SET BY : Luthada O
SETUP FILE : STANDARD.SET

INCLINATION :
DIAM :
DATE : 31/05/2021
DATE : 31/05/2021
DATE : 08/07/2021 05:43
TEXT : ..oilProfiles\Profiles.txt

ELEVATION :
X-COORD :
Y-COORD :

HOLE No: TP3

Scale
1:25

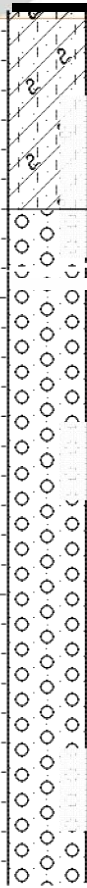

0.00 Slightly moist, Reddish brown, firm, silty sandy clay and abundant of fine to medium roots: Transported soils.

0.70 Slightly moist, Reddish brown, loose, silty sandy gravel : Pebble Marker

0.90 Slightly moist, Orangish brown, Medium dense to dense, sandy gravel: Residual Gneiss.

3.00

NOTES









- 1) No Refusal of TLB @ 3.0m
- 2) No water seepage observed
- 3) CBR/FI @0.00 - 0.70m

CONTRACTOR :
MACHINE :
DRILLED BY :
PROFILED BY : Luthada O
TYPE SET BY : Luthada O
SETUP FILE : STANDARD.SET

INCLINATION :
DIAM :
DATE : 31/05/2021
DATE : 31/05/2021
DATE : 08/07/2021 05:43
TEXT : ..oilProfiles\Profiles.txt

ELEVATION :
X-COORD :
Y-COORD :

HOLE No: TP4

	GRAVELS/gravel	{SA02}
	SAND	{SA04}
	SANDY	{SA05}
	SILTY	{SA07}
	CLAY	{SA08}
	ROOTS	{SA40}
	POCKETS	{SA60}
	COBBLES	{SA58}

CONTRACTOR :
MACHINE :
DRILLED BY :
PROFILED BY :

TYPE SET BY : Luthada O
SETUP FILE : STANDARD.SET

INCLINATION :
DIAM :
DATE :
DATE :

DATE : 08/07/2021 05:43
TEXT : ..oilProfiles\Profiles.txt

ELEVATION :
X-COORD :
Y-COORD :

APPENDIX E





706

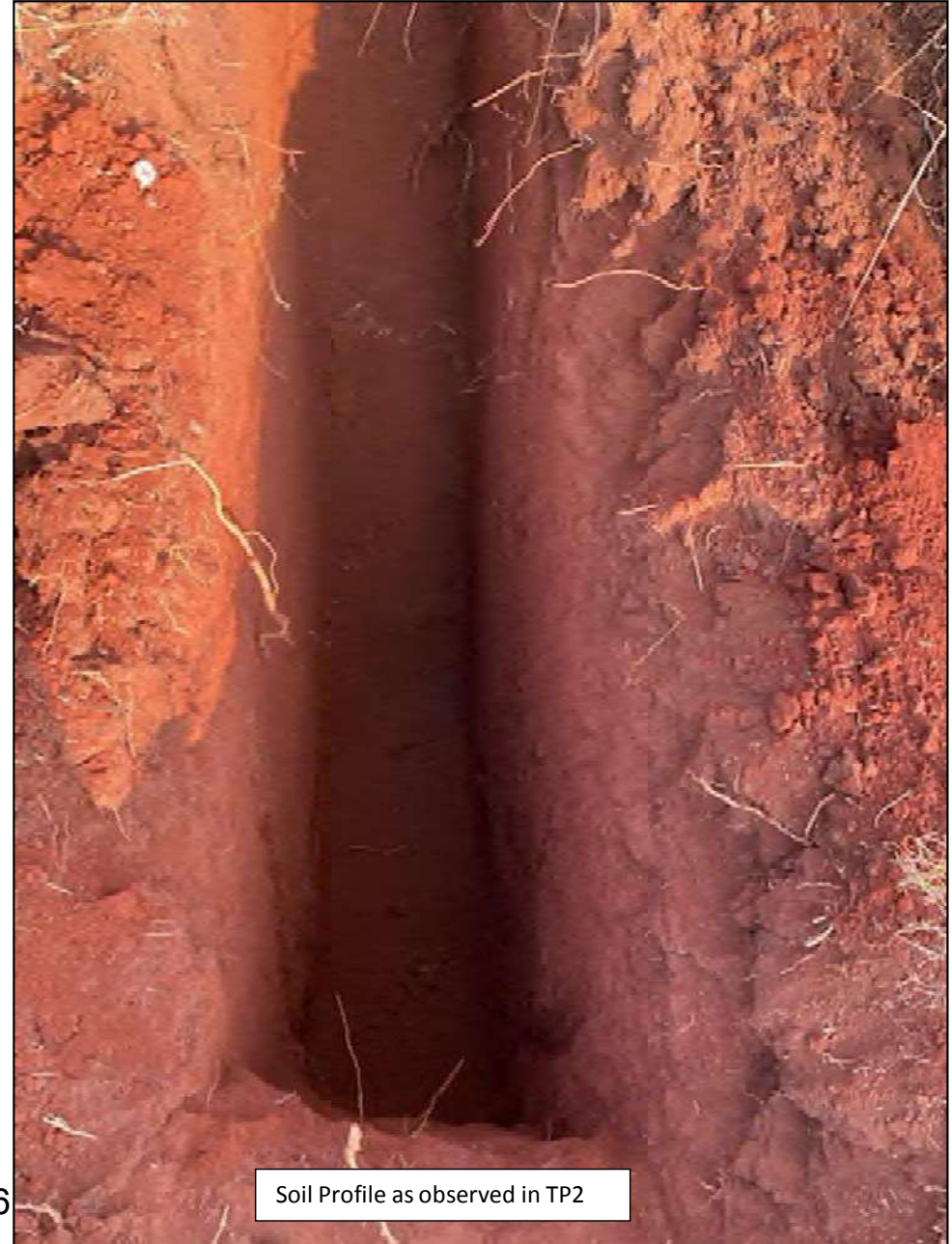



Soil Profile as observed in TP3

707



Soil Profile as observed in TP4

APPENDIX F

PARTICLE SIZE ANALYSIS

Sample No.	01
Soillab Sample No.	S21-0493-01
Depth (m)	0.0 - 2.30
Position	TP02 VLEIFONTEIN
Material Description	DUSKY RED SANDY CLAY
Relative density on < 2 mm (SANS 5844)	2.707
Organic Material	
Moisture (%) / Dispersion (%)	
SCREEN ANALYSIS (% PASSING) (SANS 3001:GR1)	
63.0 mm	100
50.0 mm	100
37.5 mm	100
28.0 mm	100
20.0 mm	100
14.0 mm	100
5.0 mm	100
2.00 mm	97
0.425 mm	91
0.075 mm	82
HYDROMETER ANALYSIS (% PASSING) (SANS 3001:GR3)	
49 µm	69
28 µm	68
12 µm	59
5 µm	53
2 µm	53
% Clay	53
% Silt	16
% Sand	28
% Gravel	3
ATTERBERG LIMITS (SANS 3001:GR10)	
Liquid Limit	43
Plasticity Index	12
Linear Shrinkage (%)	6.0
Grading Modulus	0.30
Classification	A-7-5 (11)
Unified Classification	ML
Chart Reference	-----

PROJECT : VLEIFONTEIN LIBRARY
 JOB No. : S21-0493
 DATE : 2021/06/02

POTENTIAL EXPANSIVENESS

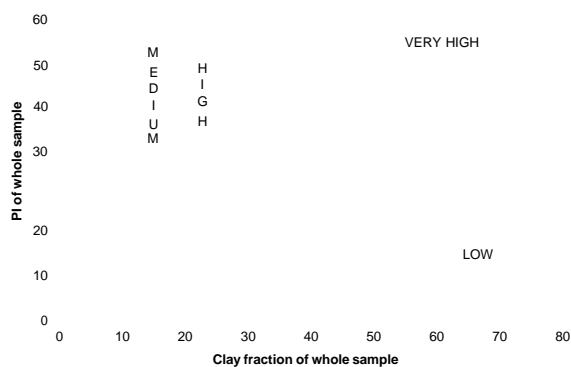

PLASTICITY CHART

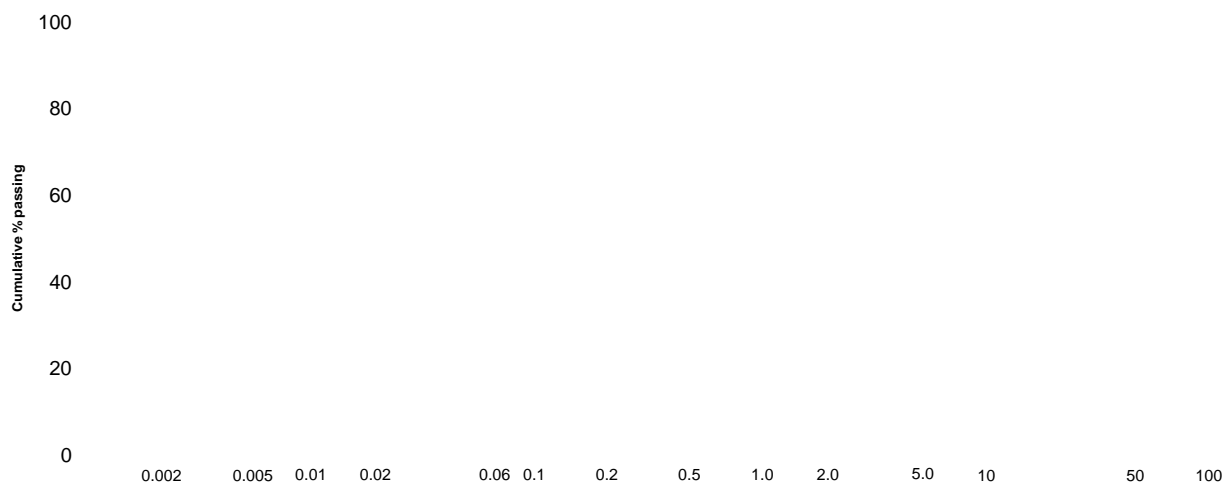
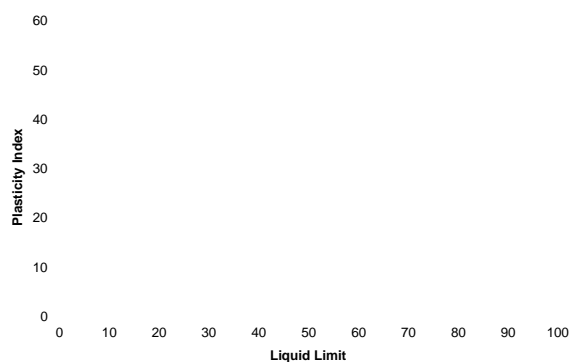

CLAY	SILT	SAND	GRAVEL
------	------	------	--------

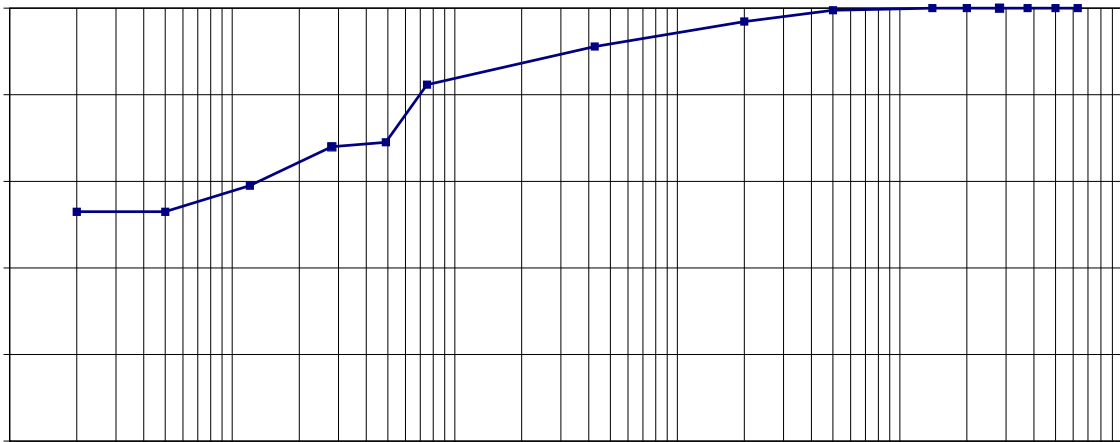
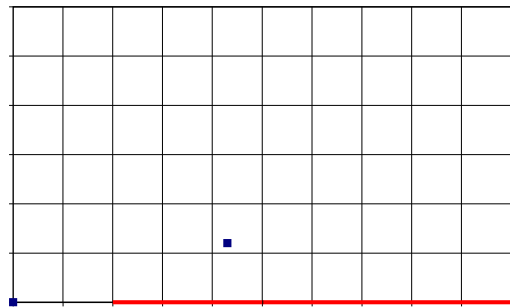
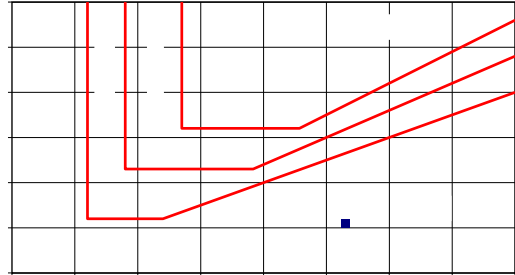

PARTICLE SIZE ANALYSIS

Sample No.	02
Soillab Sample No.	S21-0493-02
Depth (m)	0.0 - 0.70
Position	TP04 VLEIFONTEIN
Material Description	DUSKY RED SANDY CLAY
Relative density on < 2 mm (SANS 5844)	2.810
Organic Material	
Moisture (%) / Dispersion (%)	
SCREEN ANALYSIS (% PASSING) (SANS 3001:GR1)	
63.0 mm	100
50.0 mm	100
37.5 mm	100
28.0 mm	100
20.0 mm	100
14.0 mm	100
5.0 mm	100
2.00 mm	97
0.425 mm	90
0.075 mm	79
HYDROMETER ANALYSIS (% PASSING) (SANS 3001:GR3)	
48 µm	65
28 µm	62
11 µm	60
5 µm	55
2 µm	50
% Clay	55
% Silt	10
% Sand	32
% Gravel	3
ATTERBERG LIMITS (SANS 3001:GR10)	
Liquid Limit	46
Plasticity Index	15
Linear Shrinkage (%)	8.0
Grading Modulus	0.34
Classification	A-7-5 (13)
Unified Classification	ML
Chart Reference	-----

PROJECT : VLEIFONTEIN LIBRARY
 JOB No. : S21-0493
 DATE : 2021/06/02

POTENTIAL EXPANSIVENESS

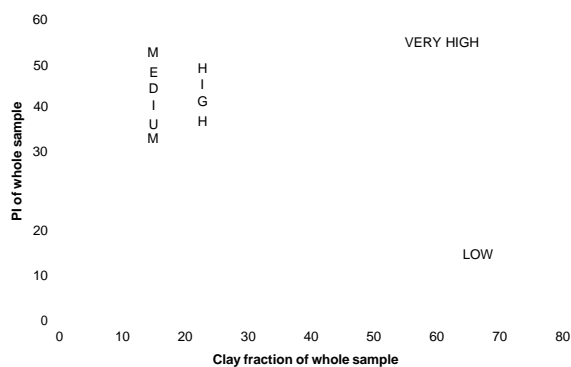

PLASTICITY CHART

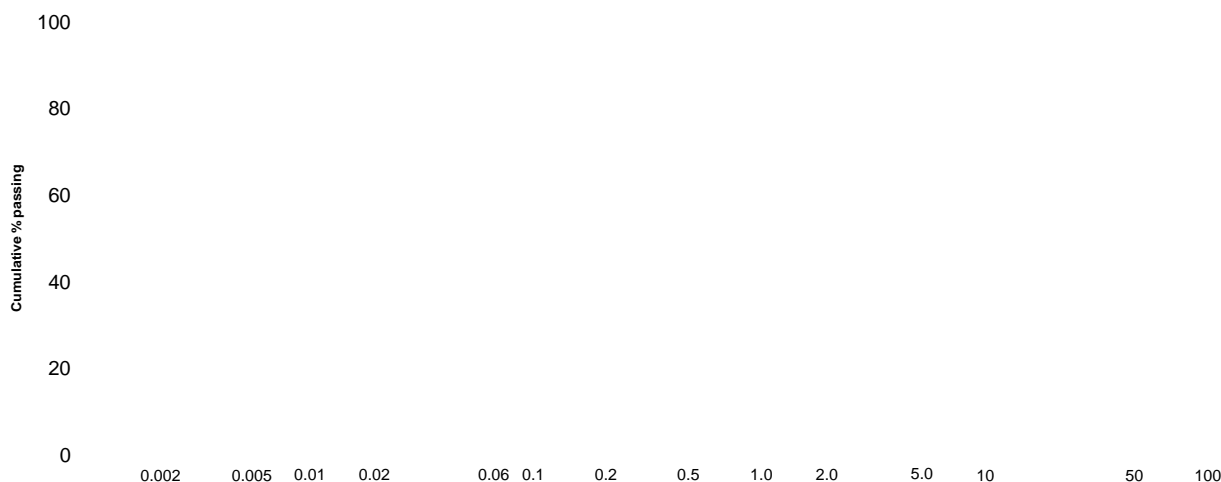
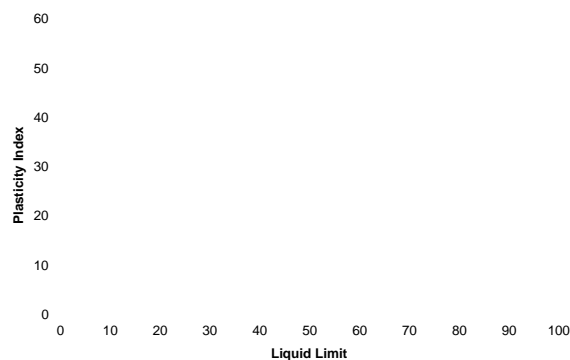

CLAY	SILT	SAND	GRAVEL
------	------	------	--------

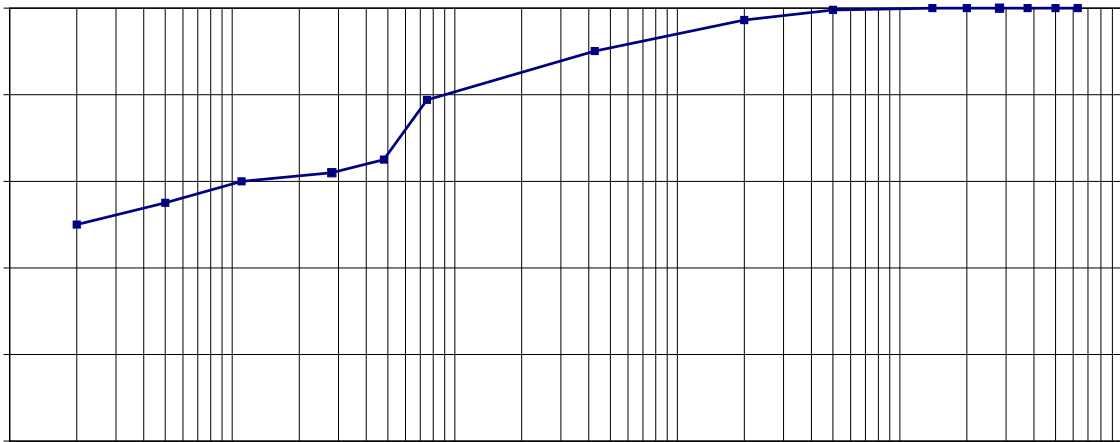
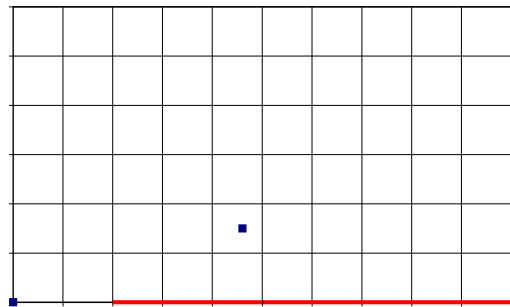
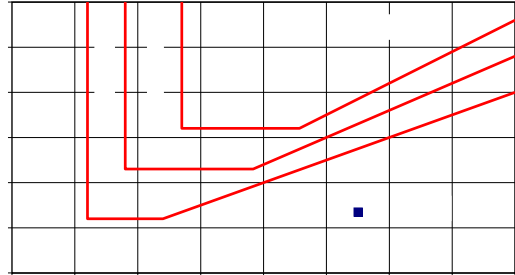

PARTICLE SIZE ANALYSIS

Sample No.	06
Soillab Sample No.	S21-0493-06
Depth (m)	0.6 - 3.0
Position	TP03 VLEIFONTEIN
Material Description	DUSKY RED SANDY GRAVEL
Relative density on < 2 mm (SANS 5844)	2.819
Organic Material	
Moisture (%) / Dispersion (%)	
SCREEN ANALYSIS (% PASSING) (SANS 3001:GR1)	
63.0 mm	100
50.0 mm	100
37.5 mm	95
28.0 mm	91
20.0 mm	88
14.0 mm	86
5.0 mm	55
2.00 mm	44
0.425 mm	30
0.075 mm	25
HYDROMETER ANALYSIS (% PASSING) (SANS 3001:GR3)	
49 µm	20
29 µm	18
12 µm	13
5 µm	10
2 µm	9
% Clay	10
% Silt	10
% Sand	24
% Gravel	56
ATTERBERG LIMITS (SANS 3001:GR10)	
Liquid Limit	42
Plasticity Index	10
Linear Shrinkage (%)	5.0
Grading Modulus	2.01
Classification	A-2-5 (0)
Unified Classification	GM
Chart Reference	-----

PROJECT : VLEIFONTEIN LIBRARY
 JOB No. : S21-0493
 DATE : 2021/06/02

POTENTIAL EXPANSIVENESS

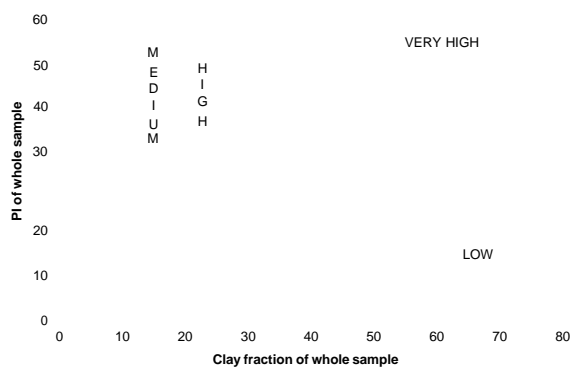

PLASTICITY CHART

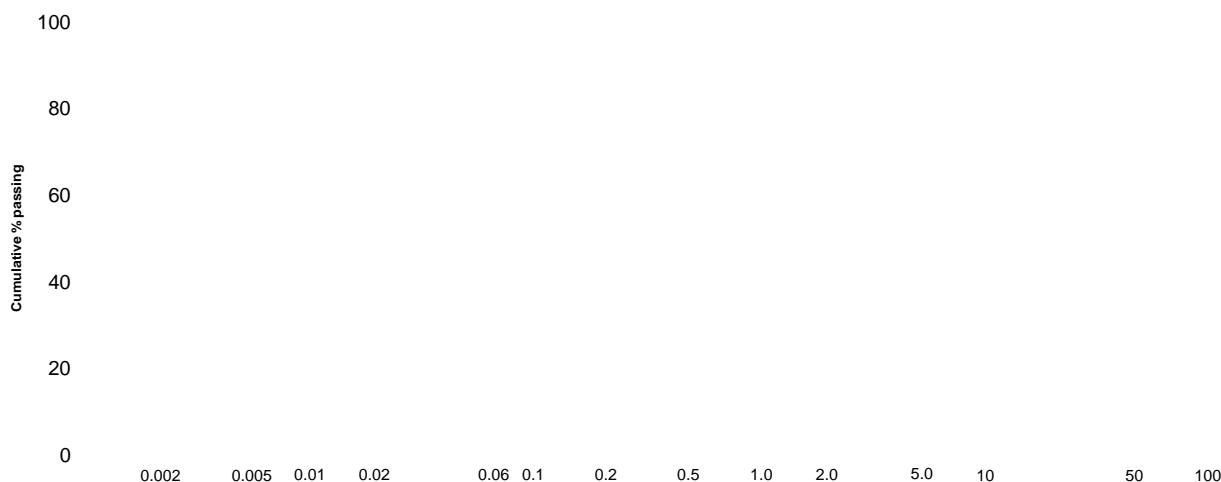
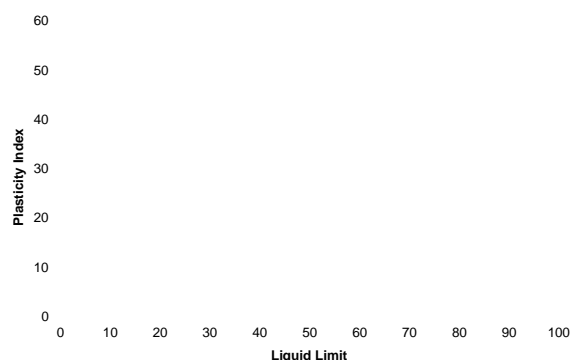

CLAY	SILT	SAND	GRAVEL
------	------	------	--------

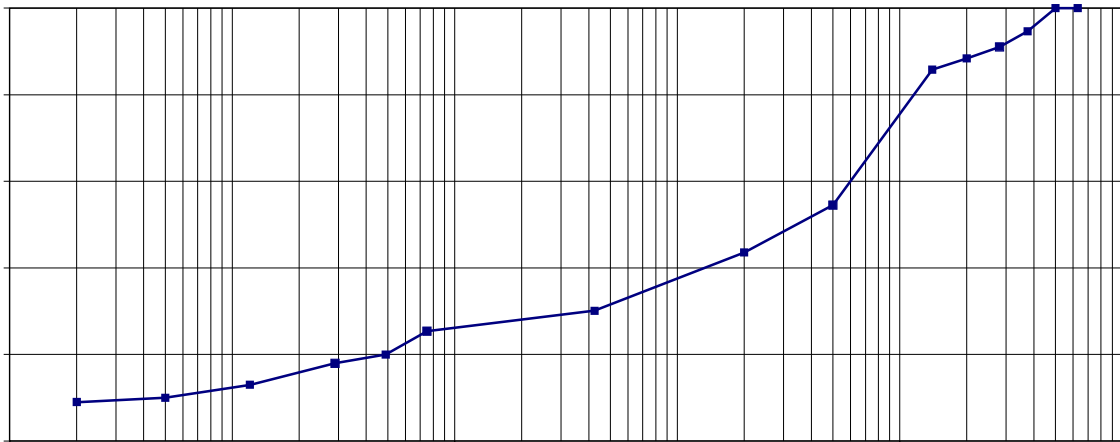
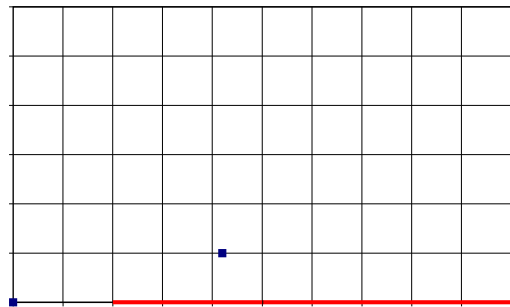
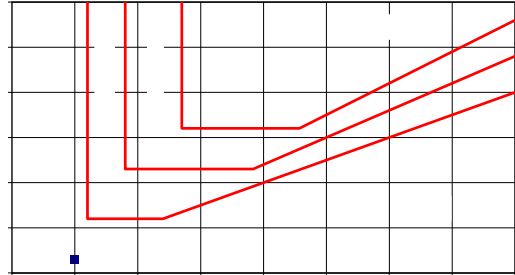

Collapse Potential

Project:	Vleifontein Library
Client:	Diges Group
Geolab Job Nr:	S21-493
Test Method:	TMH 6 ST10

Sampling Method:	Block
Disturbed/Undist:	Undisturbed
Remoulded To:	NA

Results	
Collapse Potential:	8.8 %

	Initial	Final	
Sample Height:	20.00	17.26	mm
Sample Mass:	93.6	98.9	g
Dry Density:	1468	1701	kg/m ³
Density:	1556	1905	kg/m ³
Moisture Content:	6.0	12.0	%
Void Ratio:	0.793	0.547	
Specific Gravity:	2.632		Mg/m ³

Load kPa	Height mm	Void Ratio
2.7	20	0.793
14.3	19.984	0.791
26.6	19.956	0.789
51.5	19.912	0.785
100.7	19.675	0.764
199.8	19.282	0.728
199.8	17.594	0.577
397.2	17.26	0.547

Sample Nr:	S21-493
Sample Depth:	0.70 - 0.90
Date:	2021/06/18

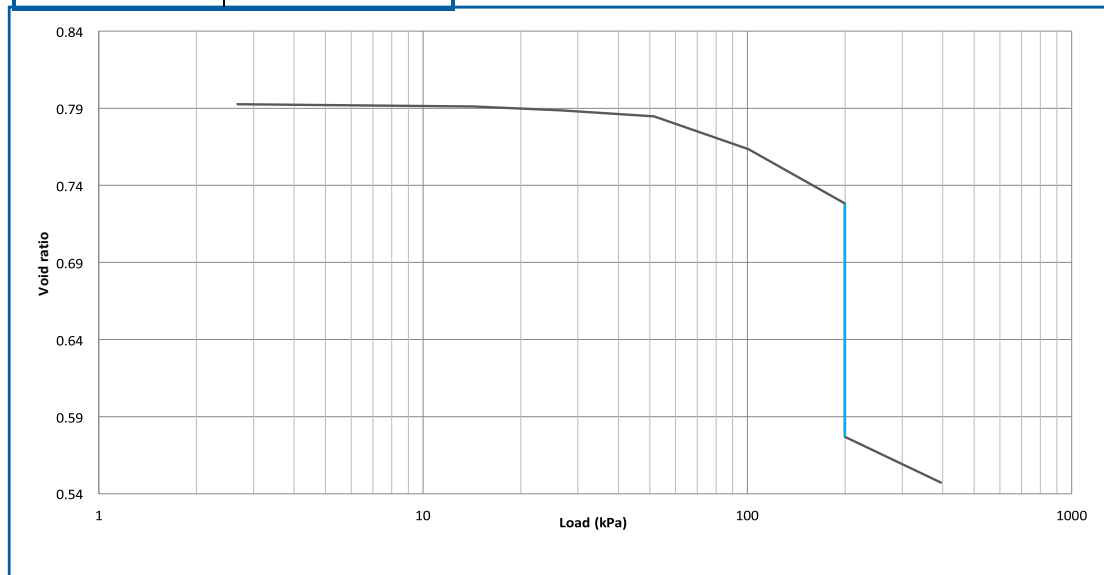

T +27 12 813 4936

Geotechnical Laboratory
E
Geolab@soillab.co.za
Geolab
www.soillab.co.za

R108 Rev 1



Project Description

Client:	DIGES GROUP	Soillab Job No.:	S21-0493
Job Description:	VLEIFONTEIN LIBRARY	Contract Number:	
Date:	2021/06/24	Reference Number:	

Sample Description

Soillab Sample No.:	S21-0493-01	S21-0493-02	
Sample Description:	TP02-VLEIFONTEIN	TP04-VLEIFONTEIN	
Sample Depth:	0.0 - 2.30	0.0 - 0.70	
Material Description:	DUSKY RED	DUSKY RED	

Screen Analysis (% Passing) - SANS 3001-GR1

75,00 mm	100	100	
63,00 mm	100	100	
50,00 mm	100	100	
37,50 mm	100	100	
28,00 mm	100	100	
20,00 mm	100	100	
14,00 mm	100	100	
5,00 mm	100	100	
2,000 mm	97	97	
0,425 mm	91	90	
0,075 mm	82	79	

Soil-mortar percentages - SANS 3001-PR5

Coarse Sand	2.000-0.425mm	6	7	
Coarse Fine Sand	0.425-0.250mm	3	5	
Medium Fine Sand	0.250-0.150mm	3	3	
Fine Fine Sand	0.150-0.075mm	3	4	
Silt and clay	<0.075mm	85	81	

Constants

Grading Modulus	SANS 3001-PR5	0.30	0.34	
Liquid Limit		43	46	
Plasticity Index	SANS 3001-GR10	12	15	
Linear Shrinkage		6.0	8.0	

MOD AASHTO - SANS 3001-GR30

Max Dry Density (kg/m ³)	1622	1656	
Optimum Moisture Content (%)	21.8	19.7	

CBR - SANS 3001-GR40

MOD AASHTO			
Moulding Moisture Content (%)	21.8	20.0	
Dry Density (kg/m ³)	1645	1656	
% of Max Dry Density	101.4	100.0	
100% MOD CBR (%)	16	8	
% Swell	0.2	0.3	
NRB			
Dry Density (kg/m ³)	1573	1586	
% of Max Dry Density	97.0	95.8	
100% NRB CBR (%)	12	8	
% Swell	0.3	0.5	
PROCTOR			
Dry Density (kg/m ³)	1486	1501	
% of Max Dry Density	91.6	90.7	
100% PROCTOR CBR (%)	8	7	
% Swell	0.4	0.6	
CBR (%)			
100% Mod AASHTO	15	8	
98% Mod AASHTO	13	8	
97% Mod AASHTO	12	8	
95% Mod AASHTO	10	8	
93% Mod AASHTO	9	7	
90% Mod AASHTO	7	7	
COLTO Classification:	>G9	>G9	

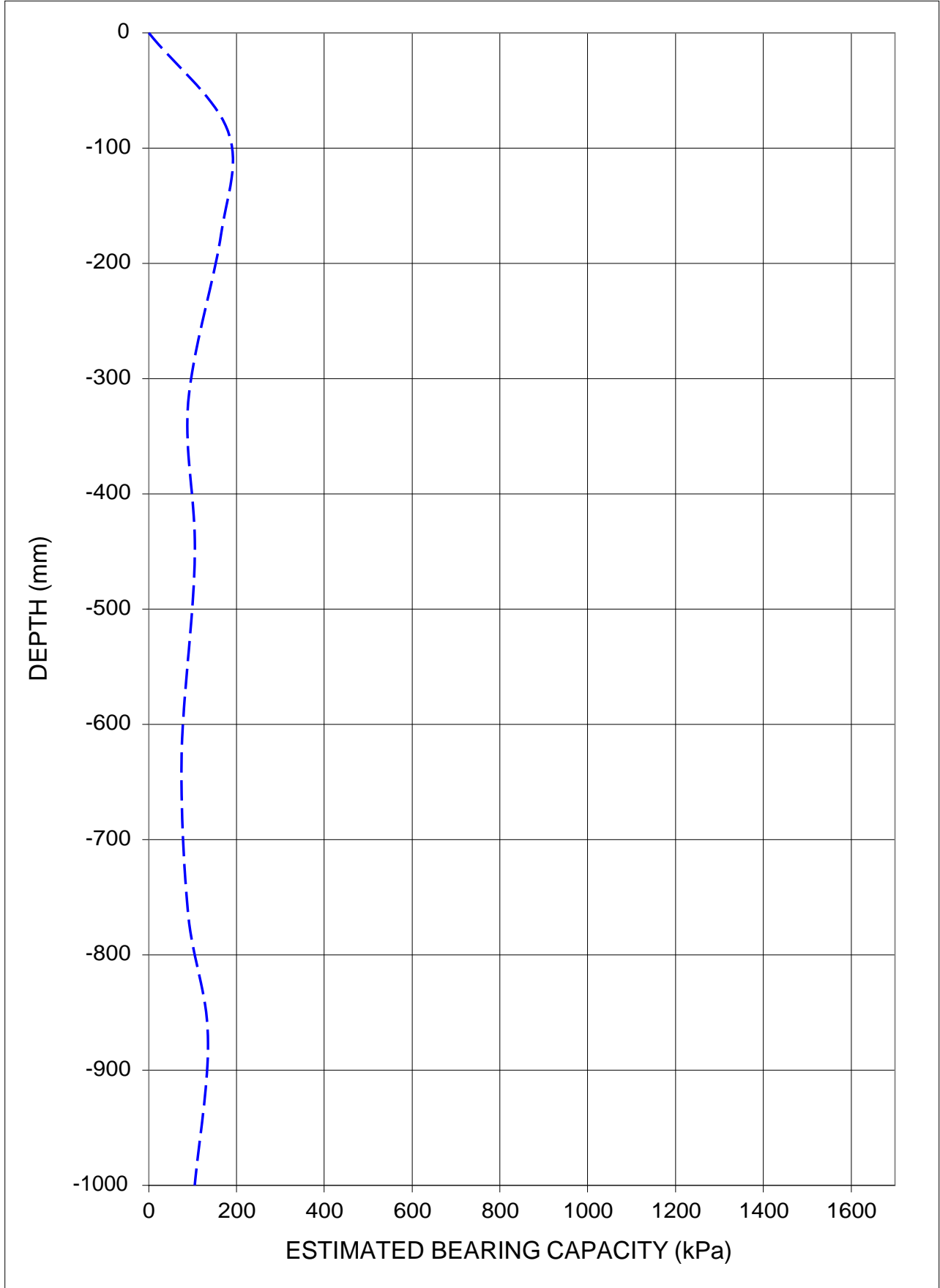

NOTES: No Refusal @ 1000mm

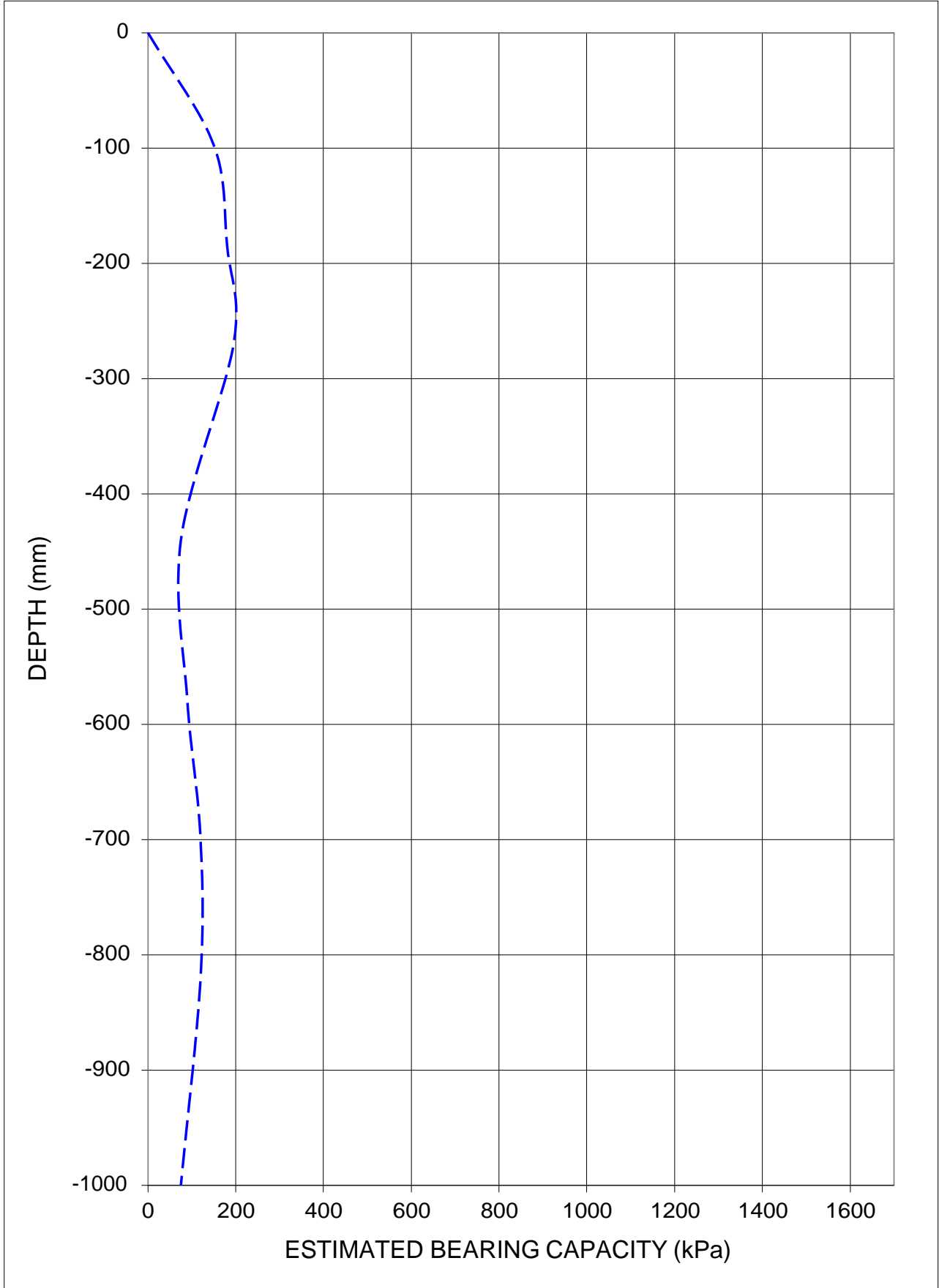

NOTES: No Refusal @ 1000mm

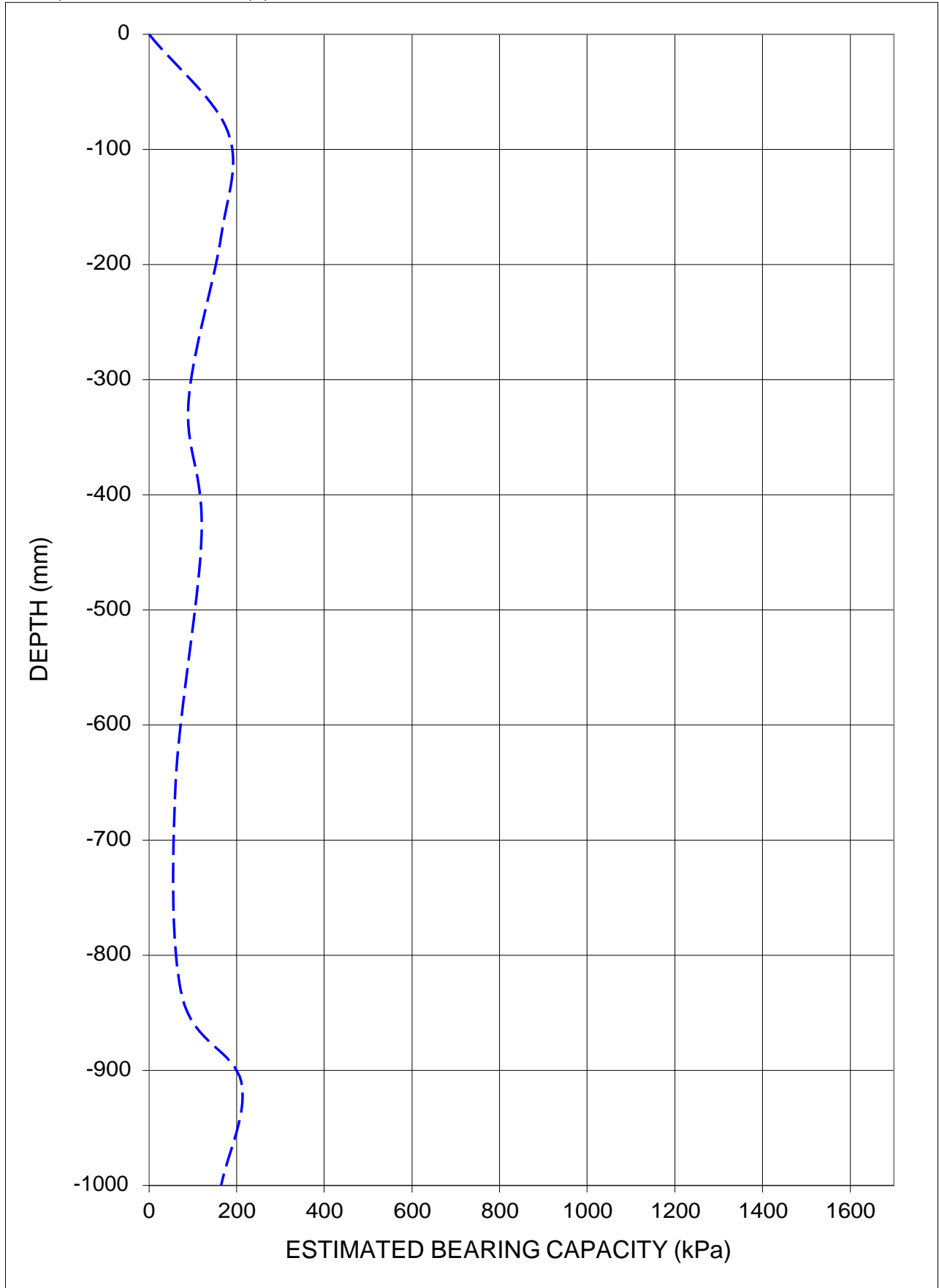

NOTES: No Refusal @ 1000mm

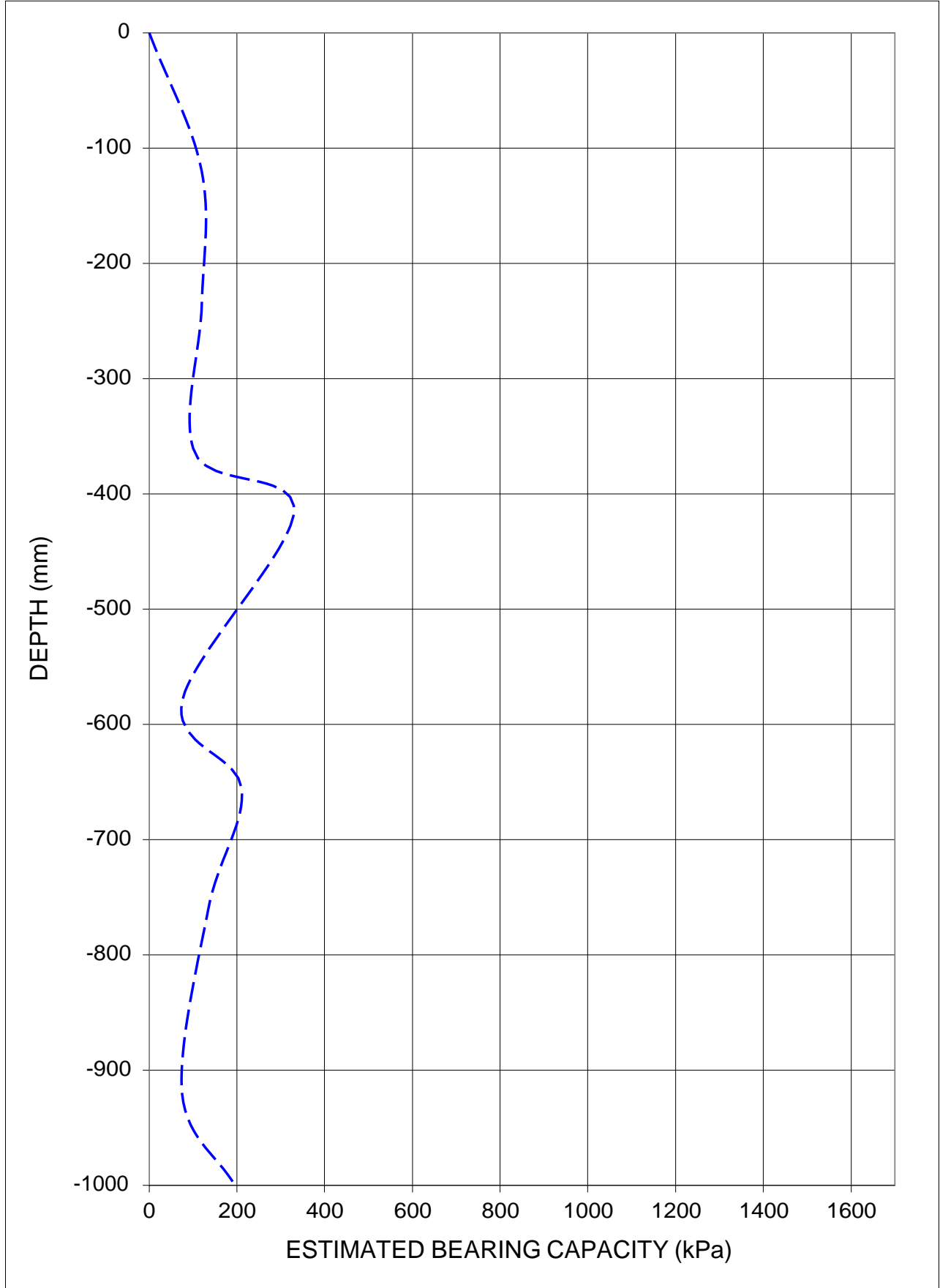

NOTES: No Refusal @ 1000mm

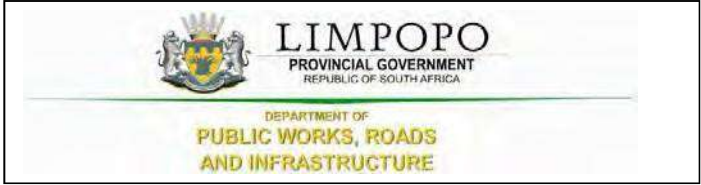

PART C7.2. 7: OHS RISK ASSESSMENT

BASELINE HEALTH & SAFETY RISK ASSESSMENT

CONSTRUCTION OF NEW LIBRARY - INCLUDING ELECTRICAL, MECHANICAL INSTALLTION AND ASSOCIATED EXTERNAL WORKS AT VLEIFONTEIN



CLIENT:



LIMPOPO
PROVINCIAL GOVERNMENT
REPUBLIC OF SOUTH AFRICA

DEPARTMENT OF
PUBLIC WORKS, ROADS & INFRASTRUCTURE

IMPLEMENTING AGENT:



LEMÉG
ARCHITECTS

CLIENT SAFETY AGENT:



WORKSAFE
Occupational Safety Practitioners

WJ van Rensburg
SACPCMP – CAN CHSA/087/2017
SACPCMP – CHSM/915/2019

Date compiled: 10 OCTOBER 2021
Date reviewed: 12 OCTOBER 2021
Review nr: 002
Next reviewal Date: OCTOBER 2023

BASELINE RISK ASSESSEMENT: DOCUMENT CONTROL RECORD

Document prepared by: **Worksafe**
Reg nr: 2002/052682/23

297 Marlothii Street
Broadlands Estate
Polokwane
0699
South Africa



PO Box 12247
Bendor Park
Polokwane
0700

Mr WJ van Rensburg
Health and Safety Consultant (Can CHSA – SACPCMP 087/2017)
T: +27 15 296 4624/5
F: +27 15 296 4614
E: willie@worksafelim.co.za

CONTROL SHEET:

Declaration

This original document has been prepared, reviewed by the undersigned:

ORIGINAL		CLIENT
Prepared by: Worksafe	Reviewed by: Worksafe	Commented on by: LDPWRI
Name: W J van Rensburg	Name: JP Spies	Name:
Signature: 	Signature: 	Signature:
Date: 12 OCTOBER 2021	Date: 12 OCTOBER 2021	Date: 12 OCTOBER 2021
Capacity: Health and Safety Manager: Worksafe (Risk Assessor)	Capacity: CHSM Safety Manager	Capacity: Client: LDPWRI

PRINCIPAL CONTRACTOR RECEIPT	
Received by:	
Name:	
Signature:	
Date:	
Capacity: CEO:	

REVISIONS:

PRE-DESIGN REVISION 1		COMPANY
Prepared by:	Reviewed by:	Received by:
Name:	Name:	Name:
Signature:	Signature:	Signature:
Date:	Date:	Date:
Capacity: Agent	Capacity: Agent	Capacity:

REVISION 2 (For tender purpose)		COMPANY
Prepared by:	Reviewed by:	Received by:
Name:	Name:	Name:
Signature:	Signature:	Signature:
Date:	Date:	Date:
Capacity:	Capacity:	Capacity:

REVISION 3: (Changes during Construction)		COMPANY
Prepared by:	Reviewed by:	Received by:
Name:	Name:	Name:
Signature:	Signature:	Signature:
Date:	Date:	Date:
Capacity:	Capacity:	Capacity:

COPYRIGHT

All rights reserved, including the use of this document or its contents.

INDEX:

- 1) INTRODUCTION/BACKGROUND: BASELINE METHODOLOGIES**
- 2) WHEN SHOULD BASELINE RISK ASSESSMENTS BE CONDUCTED?**
- 3) WHAT DOES A FORMAL BASELINE RISK ASSESSMENT ENTAIL?**
- 4) PURPOSE/AIM OF BASELINE RISK ASSESSMENT?**
- 5) TYPICAL HAZARDS**
- 6) DEFINITIONS**
- 7) RISK MANAGEMENT METHODOLOGY**
- 8) RISK ASSESSMENT TEAM**
- 9) SCOPE OF WORK**
- 10) HEALTH & SAFETY RISK ASSESSMENT**

1. INTRODUCTION/BACKGROUND: BASELINE METHODOLOGIES:

- A Baseline Risk Assessment is the procedure by which the risks posed by inherent hazards and associated risks involved in the process or situations are estimated either quantitatively or qualitatively.
- The management of Contractor Management will use the Baseline Risk Assessment as a systematic process of managing risks proactively.
- It is the Client's Managements vision to complete Baseline Risk Assessments to ensure:
 - The correct selection of suitable equipment and tools are used for the construction work activities.
 - Ensuring Contractors employees and Public Health & Safety is ensured at all times.
 - Setting out of Safe Work Procedures at all construction work areas.
 - Ensuring that the contractor's personnel & employees area properly and adequately trained.
 - Ensuring proper supervision of all construction work.
 - Compliance to Sections 8; 13 and 14 of the Occupational Health & Safety Act, Act 85 of 1993.
 - In the Construction industry the workers employees tasks require repetitive motions, heavy lifting, long periods of standing and other hazards which could lead and result in injury (see typical hazards described under point 5 below).
 - **LIMPOPO DEPARTMENT OF PUBLIC WORKS, ROADS & INFRASTRUCTURE** Store Management wants to identify any source of exposure to danger or harm in the construction environment.

Why is LIMPOPO DEPARTMENT OF PUBLIC WORKS, ROADS & INFRASTRUCTURE serious about conducting Risk Assessments?

- Legal responsibility
- Risk averse
- System requirement
- Financial savings through implementation of controls
- Moral obligation towards employees and customers
- Implementation of SHE Management System
- **LIMPOPO DEPARTMENT OF PUBLIC WORKS, ROADS & INFRASTRUCTURE** is committed to define hazards/risks as per the legislation in terms of Section 8(2)(d) of the OHSACT 85 of 1993, where an employer is required to establish, as far as reasonably practicable what hazards area attached to the Health & Safety of persons (workers and public)

It is important to understand OHSA Sect 8(d) and Sect 13: Duty to inform:

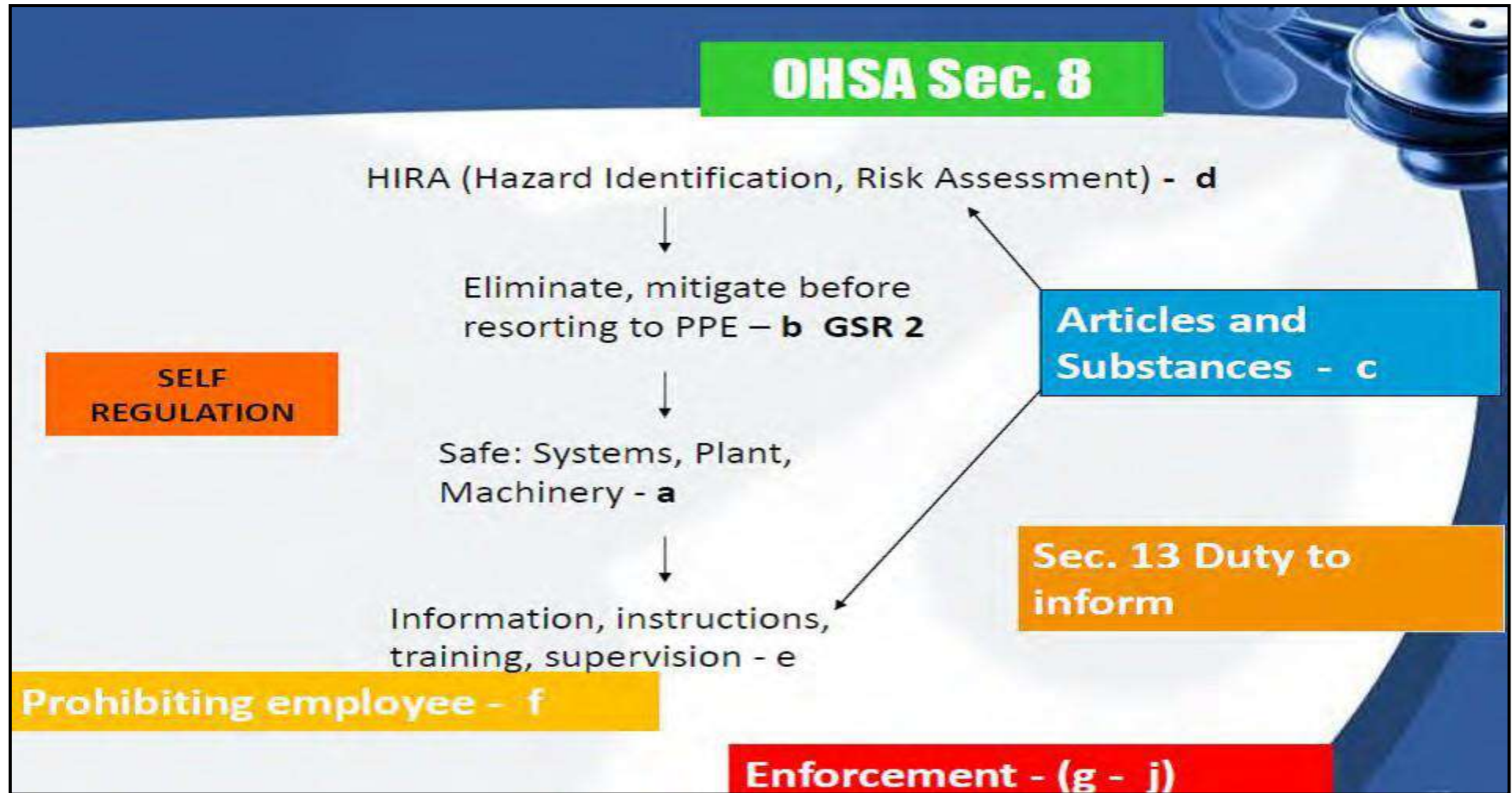

2. WHEN SHOULD WE CONDUCT RISK ASSESSMENTS:

The risk assessment procedure is intended for use under the following circumstances:

- For existing operations where hazards appear to pose a significant threat and it is uncertain whether existing or planned controls are adequate in principle or in practice.
- When new plant or equipment is installed.

- Fire Risk Evaluation
- Occupational Hygiene Stressors
- Major Hazardous Installations installed or re-assessed by AIA
- Electrical zoning surveys
- Before new work is performed that is not governed by a safe working procedure.
- Before emergency work (out of routine activities/ non-routine) are to be performed.
- In pursuing continuous improvement in excess of the minimum legal requirements
- Risk Assessments must be reviewed after the occurrence of a significant OHSE incident.
- To determine those aspects that have or can have significant impact (s) on the environment (i.e. significant environmental aspects)

3. WHAT DOES A FORMAL BASELINE RISK ASSESSMENT ENTAIL?



4. PURPOSE / AIM OF BASELINE RISK ASSESSMENT:

- Geographical-Location of activities example welding on the ground has certain risk, the same task in a vessel or in elevated position identifies additional risk.
- Functional -Types of activities
- Pure hazards –inherently dangerous

5. TYPICAL HAZARDS IN CONSTRUCTION WORK SECTORS:

HAZARD TYPE	EXAMPLES OF HAZARD TYPE SOURCES
HUMAN ERROR	Untrained, incorrect procedure, unsafe placement or position, no or wrong PPE use, wrong manual handling, poor housekeeping, slipping/tripping & falling, suffocation, poor ergonomics
ENTANGLEMENT	Long hair/clothing/glove/jewellery materials caught & drawn into moving parts
CRUSHING	Falling off or under plan, uncontrolled movement of plant, plant/equipment collapsing or turning over, moving part contact
CUTTING, STABBING & PUNCTURING	By sharp or flying object contact, contact with moving parts, item being ejected or disintegrating
SHEARING	A body part between a moving & fixed item or plant, or between two moving parts of a plant or item, guillotining
FRICTION	Heat generation sources, hot surfaces or moving parts which can burn or hot materials being handled
STRIKING/STRUCK BY	Mobile or uncontrolled or unexpected plant/equipment or materials being handled, plant/equipment/parts or work piece disintegration, ejection or falling
HIGH PRESSURE	Contact with high pressure fluids due to plant/equipment failure, rupture or misuse, rock bursts, seismicity
ELECTRICAL	Live conductor contact, overloaded circuits, damaged or poorly maintained leads & cables, no lockouts, damaged switches, use near water, inadequate earthing, electrocution
EXPLOSION	Gas, vapour, liquids, dusts of other substance explosion, triggered by plant/equipment operation, materials handling or human error, exothermic reactions
H/C TEMPERATURES	High/cold temperatures surfaces/objects/materials contact or environmental exposures, fire, solidification

OTHER HAZARDS	Materials handling, chemicals, toxic gasses/vapours/fumes, dusts, noise, vibration, radiation, suffocation (lack of O ₂ or atmospheric contamination), environmental impairment (hazardous wastes handling & disposal, spillages, leaks & stress factors generation), pollution, fauna (wildlife) & flora
POISONOUS FLORA	Workers coming into contact with poisonous plants, bees & snakes

6. DEFINITIONS:

TERM	DEFINITION
ALARP (As Low As Reasonably Practicable)	The concept of weighing a risk against the sacrifice needed to implement the measures necessary to avoid the risk. With respect to health and safety, it is assumed that the measures should be implemented unless it can be shown that the sacrifice is grossly disproportionate to the benefit.
Consequence	The outcome of an unwanted event (risk scenario) expressed qualitatively or quantitatively. It is usual to consider this in terms of the maximum reasonable potential outcome.
Control Measure (or Control)	A means to reduce the likelihood of a risk occurring and / or minimise the consequences once an event has occurred.
Hazard	A source of potential harm in terms of human injury or ill health, or a combination of these. A hazard is typically an energy source.
Likelihood	The probability or chance that an unwanted event will occur.
Major Hazard (Risk)	A hazard (risk) involving a consequence of more than one fatality.
Priority Unwanted Event (PUE)	Any event with a maximum consequence rating of either 4 or 5 (high and major) with regard to the Risk Management risk matrix.
Risk	A combination of the likelihood of the occurrence of an unwanted event (risk scenario) and the severity of injury or ill health that can be caused by the event.
Risk Assessment	A process of evaluating the risk scenarios arising from identified hazards, and identifying control measures that are as effective as possible in order to manage the risks to levels that are as low as is reasonably practicable.
Unwanted Event (or Risk Scenario)	A description of a potential situation in which a hazard causes injury or ill health to a person or persons.
WRAC (Workplace Risk Assessment and Control)	A structured review technique to identify and analyse hazards in the workplace and to check the adequacy of existing or planned hazard controls.

7. METHODOLOGY:

The Baseline Health and Safety Risk Assessment is carried out in accordance with the requirements of the Client Coherent Health & Safety Specification.

A risk rating is assigned to each unwanted event (risk scenario) taking the identified control measures into consideration. Risk ratings is assigned qualitatively using the Risk Rating Matrix detailed in Table 7-1.

RISK RATING MATRIX					
Most Likely Consequence	Likelihood				
	Very likely to occur	Good chance to occur	Likely to occur	Unlikely to occur	Very unlikely to occur
Disastrous	Extreme	Extreme	Extreme	Extreme	High
Critical	Extreme	Extreme	Extreme	High	High
Serious	Extreme	High	High	Moderate	Moderate
Significant	High	High	Moderate	Low	Low
Minor	Moderate	Moderate	Low	Low	Low
Consequence	Example		Likelihood	Example	
Disastrous	Single or multiple fatality		Very likely to occur	Is expected to occur in most circumstances (i.e. could occur once per week)	
Critical	Disabling injury of illness (i.e. amputation and/or permanent loss of bodily function, or any kind of permanent health impact)		Good chance to occur	Will probably occur in most circumstances (i.e. could occur once per month)	
Serious	Any lost time injury (LTI) resulting in one or more complete days off work or any restricted work day injury (RWI) resulting in one or more than 1 week off normal duties		Likely to occur	Might occur at some time (i.e. could occur once per year)	
Significant	A medical treatment injury (MTI) or a restricted work day injury (RWI) (i.e. any injury resulting in less than 1 week on alternate duties)		Unlikely to occur	Could occur at some time (i.e. could occur in 10 years)	
Minor	Minor first aid injury (FTI) or an injury not requiring treatment		Very unlikely to occur	May occur only in exceptional circumstances (i.e. could occur once)	
RISK CATEGORY					
Rating	Response				
Extreme Risk	Cease the work immediately and notify the most senior Construction Manager responsible for the work. Immediate action required. Do not proceed with any work until confirmed safe to do so and recommencement has been authorized by the senior Construction Manager or appropriately qualified and competent person.				

High Risk	Cease the work immediately and notify the most senior Construction Manager responsible for the work. Immediate action is required. Do not proceed with any work until confirmed safe to do and recommencement has been authorized by the senior line manager or appropriately qualified and competent person.	
Moderate Risk	Notify the Construction Manager and identify control actions and action dates. Proceed with work only if confirmed safe to do so.	
Low Risk	Manage by routine procedures.	
HIERARCHY OF CONTROL		
You should attempt to remove or control the hazard in the following order. If the hazard cannot be eliminated properly then apply any one or combination controls 2-5 in descending order until the work can be done safely		
Option 1	1. Eliminate	Eliminate the hazard at its source (i.e. complete removal or termination of whatever is generating the hazard. Could be a process, work method, equipment, material or substance etc.)
Option 2 (Control the hazard through 1 or a combination of these controls)	2. Substitute	Replace whatever is generating the hazard with a non-hazardous or less hazardous process, work method, equipment, material or substance etc.
	3. Engineer /Isolate	Redesign or modify whatever is generating the hazard to control the effects of the hazard or prevent people from coming into contact with it. This includes isolating the hazard to prevent access. Engineer and redesign includes the use of barriers, guards, enclosures, engineering control systems and protective devices, redesign layouts and work processes, design of new equipment to handle the hazardous source, etc.
	4. Administrative	Administrative controls include the use of procedures, training and information, signage, hours of work etc.
	5. Personal Protective Equipment (PPE)	Use appropriately designed and properly fitting personal protective equipment (PPE) where other controls are not practicable. (This is not a primary control. It is a back-up control and should be considered only as a support to the other controls).

8. RISK ASSESSMENT TEAM:

Table 8-1: Risk Assessment Attendees

Name	Organisation	Designation
WILLIE JANSEN VAN RENSBURG	WORKSAFE	RISK ASSESSOR
JP SPIES	WORKSAFE	RISK ASSESSOR

9. SCOPE OF WORK: CONSTRUCTION OF NEW LIBRARY

These Specifications set out the requirements for eliminating or if this is not possible, for minimising as far as reasonably practicable, the risk of incidents and injuries occurring on this project. **This document covers work to be undertaken on this project and sets out the rules and procedures for engagement on the project.**

The scope also addresses legal compliance, **LIMPOPO DEPARTMENT OF PUBLIC WORKS, ROADS & INFRASTRUCTURE** standards, hazard identification and risk assessment, risk control, and the promotion of a health and safety culture amongst those working on the project.

These baseline risk assessment are applicable to the specific scope of work pertaining to the **CONSTRUCTION OF NEW LIBRARY – INCLUDING ELECTRICAL, MECHANICAL INSTALLATION AND ASSOCIATED EXTERNAL WORKS AT BOTSHABELO, IN THE WATERBERG DISTRICT** as detailed in the tender documents including the following:

The **CONSTRUCTION OF NEW LIBRARY – INCLUDING ELECTRICAL, MECHANICAL INSTALLATION AND ASSOCIATED EXTERNAL WORKS AT VLEIFONTEIN** will cover the following main items:

- **EARTHWORKS**
 - Site clearance
 - Filling (general)
 - CBR and indicator tests to be done
 - Density tests to be done
 - Carting away of excessive and/or unsuitable excavated materials
 - Layer works
 - Sand bed spread over layer works
 - Stabilization of compacted layers
 - Compaction of surfaces
- **EXCAVATION WORKS**
 - Excavate Trenches (Including for electrical and plumbing services)
 - Backfill excavations
 - Preparation of sand bed
 - Compaction of soil
- **SOIL POISONING**
 - To bottom and sides of trenches, holes, etc
 - Under floors, etc including forming and poisoning shallow furrows against foundation walls, etc
 - Under paving, aprons, etc
- **CONCRETE, FORMWORK AND REINFORCEMENT**
 - Concrete test cubes
 - Formwork
 - Preparation of steel fixing.

- Mass concrete casting (column bases, surface beds, ramps, ground beams)
- Casting of beams and inverted beams
- Casting of columns
- Casting of stub columns
- SUNDRIES
 - Finishing surfaces of concrete smooth with a wood float(surface beds, slabs, aprons, ramps, etc)
- STRUCTURAL STEEL WORKS
 - Installation of mild steel columns and beams
 - Installation of mild steel bolted purlins, girts, bracing, etc
 - Installation of steel trusses (hoisting into position).
 - Painting of steel structure.
- MOVEMENT JOINTS
 - Movement joints
 - Expansion joints
- MASONRY (BRICKWORK + FACE BRICK)
 - Installation of wall ties
 - Sub-structure brick work (foundation)
 - Installation of brick reinforcement in foundation
 - Superstructure brick work including brick reinforcement, turning pieces, movement joints (half brick walls, half brick walls in beam filling, half brick walls in fire wall, yard brick walls.)
- PLASTERING WORKS
- WATERPROOFING
 - Damp proofing of walls and floors
- JOINT SEALANTS
 - Silicone sealing between timber fittings and plastered walls
 - Silicone sealing between sanitary fittings and wall ties
 - Sealing in expansion joints
- ROOF COVERINGS
 - Installation of roof purlins, trusses, etc
 - Installation of prefabricated roof trusses
 - Insulation installation
 - Installation of sheet metal flashing, linings, copings, etc.
 - Installation of galvanised steel sheeting

- Installation of eaves, verges, etc
- INSTALLATION OF ALUMINIUM WINDOWS, ETC
- INSTALLATION OF TIMBER SKIRTINGS
- INSTALLATION OF DOORS
- CEILINGS, PARTITIONS AND ACCESS FLOORING
 - Installation of ceilings
 - Installation of suspended ceilings, bulkheads, etc.
 - Installation of Bates access flooring
- INSTALLATION OF IRONMONGERY
 - Installation of hinges
 - Installation of handles push plates and kicking plates
 - Installation of door closers and floor springs
 - Installation of Kimberly Clark hand soap dispenser
 - Installation of grab rails
 - Installation of steel lockers
 - Installation of pinning boards, writing board, projection screens, etc
 - Installation of signage
- METAL WORK
 - Installation of burglar bars to windows
 - Installation of glazing beads to windows
 - Installation of gates to external doors
- INSTALLATION OF ROLLER SHUTTER DOORS
- EPOXY OF FLOORS
- INSTALLATION OF WALL TILES
- INSTALLATION OF FLOOR TILES
- INSTALLATION OF PLUMBING AND DRAINAGE
 - Installation of uPVC pipes and fittings
 - Installation of copper pipes
 - Installation of flush pans
 - Installation of soil drainage
 - Installation of sanitary plumbing (uPVC pipes + fittings)
 - Fitting of sanitary (taps, hand basins, toilets, etc)

- INSTALLATION OF FIRE HOSE REELS AND 9kg DRY CHEMICAL FIRE EXTINGUISHER
- INSTALLATION OF TOPS, SHELVES, DOORS, MIRRORS, ETC
- GENERAL PAINTWORK
- GENERAL LANDSCAPING WORKS
- INSTALLATION OF CONCRETE BLOCK PAVING (ROADS)
- INSTALLATION OF ROADS SIGNS AND MARKINGS
- INSTALLATION OF FENCING
- INSTALLATION OF MAIN SEWER LINE
 - Excavation of trench
 - Bedding
 - Laying of sewer line
 - Backfilling
 - Compaction and testing
- SEWER TREATMENT WORKS
 - Construct a septic tank 2460 x 7310 x 2600mm high with soak away
 - Constructed with 25mpa bottom and top slab
- WATER AND FIRE RETICULATION
 - Excavation of trench
 - Bedding
 - Laying of lines
 - Backfilling
 - Compaction and testing
 - Installation of special fittings (fire hydrant bend: cast iron fire hydrant)
 - Construct of a valve chamber
 - Hydraulic pipe testing
- INSTALLATION OF ELEVATED AND GROUND TANKS
- INSTALLATION OF BOREHOLE
- MV RETICULATION - SUPPLY AND INSTALL 50kVA 11kV/400 TRANSFORMER COMPLETE WITH STRUCTURES AND POLES.
- LV RETICULATION
 - Installation of new Distribution Kiosk
 - Installation of plinth

- Trenching
- Laying of sleeves and cables (including cable warning tape, cable marker and labels)
- Installation of cable terminations
- Installation of earth conducted
- testing
- MAIN LIBRARY BUILDING (ELECTRICAL WORKS)
 - Draw wires
 - Installation of distribution boards
 - Build or chase into brick or concrete work
 - Installation of PVC wiring in conduits
 - Installation of copper earth wire
 - Installation of switches
 - Installation of socket outlets
 - Installation of light fittings
 - Installation of area lighting
- ELECTRONIC INSTALLATION (CCTV AND NETWORK DATA SYSTEMS)
- HVAC INSTALLATIONS
 - General HVAC installation
 - Duct work
 - Installation of air diffusor
 - Fans
 - Installation of sound attenuators
 - Installation of fan coil units, fan air terminals and fan heaters
 - Piping
 - Installation of ablution HVAC system
- FIRE DETECTION, SUPPRESION AND PROTECTION
 - Installation of fire detection system
 - Installation of fire protection system
- WATER SERVICES
 - Installation of water supply piping
 - Installation of grey water drainage piping
 - Installation of water heating system
 - Installation of water purification system

10. BASELINE HEALTH & SAFETY RISK ASSESSMENT:

Baseline Risk Assessment Form (Safe Work Method Statement)

Project name:		CONSTRUCTION OF NEW LIBRARY - INCLUDING ELECTRICAL, MECHANICAL INSTALLTION AND ASSOCIATED EXTERNAL WORKS AT VLEIFONTEIN			Project number:		LDPWRI-B/20151		
Prepared by:		WJ Jansen Van Rensburg			Approved by:		JP Spies		
Original Risk assessment date:		10 OCTOBER 2021			Review date:		OCTOBER 2022		
Task Describe the task: What is being done, by whom, how, where and with what items/materials?	Hazard Exactly what could cause injury, harm or illness?	Consequences What could happen if the hazards were not controlled?	Likelihood What is the probability that injury or damage will occur with no controls?	Risk Rating Before control	Controls Describe how the hazard will be eliminated or what actions must be taken to make the task safe.	Consequences What consequences could occur with controls in place?	Likelihood What is the probability that injury or damage will occur with controls?	Residual Risk score After control	
ACTIVITIES ASSESSED: GENERAL SITE ENVIRONMENT AND OBSERVATIONS									
1. SITE ESTABLISHMENT									
1.1. Fencing / orange netting posting (General construction area) Perimeter fence	<ul style="list-style-type: none"> Fence/ live-in contact Defective On/Off switch Inadequate warning signage Collapse of fence Incorrect selection of tools and equipment Hand tools failure/defective Power/Electrical tools failure No/late equipment and Inspections maintenance done Insufficient or no training and awareness raised No COVID-19 protocols No COVID-19 screening 	<ul style="list-style-type: none"> Electrical Shock Bodily harm / Injury Property damage Equipment damage Occupational illness Eye irritation Lost Time Injury Project standing time Possible spreading of COVID-19 virus 	Likely to occur	Moderate	<ul style="list-style-type: none"> Display clear visible readable warning signage Training for employees on Electrical fencing, standard operating procedures and applicable legislation Apply good housekeeping Wear suitable PPE General SHE Awareness Induct workers R/A Training Toolbox talks Electrical lock-out Ensure that COVID-19 protocols implemented 	<ul style="list-style-type: none"> Informed vigilant employees No injury No bodily harm No property damage No equipment damage 	Unlikely to occur	Low	
1.2. Sign Posting (site camp facility as per Spec	<ul style="list-style-type: none"> Signs not assembled properly Signage poles not stable in 	<ul style="list-style-type: none"> Sign boards falls to ground- causing bodily harm/injury 	Likely to occur	Moderate	<ul style="list-style-type: none"> Follow Sign Assemble procedure by trained skilled, 	<ul style="list-style-type: none"> Un-exposed employees No injury 	Unlikely to occur	Low	

point 3.6.8)	<p>the ground</p> <ul style="list-style-type: none"> • Incorrect signage/warnings • Signage not installed at correct area • Language barrier/not understood by employee 	<ul style="list-style-type: none"> • Wrong signalling of danger • Un-aware of existing danger • Damage to property • Wrong interpretation of warning signage • Inadequate personal protection • 1st Aid Treatment Care • LTI 			<p>knowledgeable competent workmen</p> <ul style="list-style-type: none"> • Correct displayed readable warning signage in the correct area of hazard to prevent confusion and uncertainty • Physical & Visual inspections • Train employees • Raise Awareness 	<ul style="list-style-type: none"> • No property damage • Informed employees • No confusion • No uncertainty • Defective or hazardous signs identified & corrected prior 		
1.3. Road Traffic (Access road from main entrance to site working area)	<ul style="list-style-type: none"> • Speeding vehicles/moving equipment • Speed limits not displayed • Inadequate speed or warning signage posted • Unreadable not clear traffic signage • Pedestrian walkways not clearly demarcated • Vehicle road and operating work zone areas not clearly demarcated • Drivers not adherent to work zone signs • Pedestrians not adherent to pedestrian walk ways/areas • No traffic plan/rules • Defective vehicles/moving equipment • Poor communication • No flag personal directing traffic and control in case of road diversion • Overloading of vehicles • Damaged gravel roads due to rain 	<ul style="list-style-type: none"> • Vehicle accidents • Collision between motorists • Confusion between motorists • Poor visibility for motorists & employees • Injuries/bodily harm • Multiple accidents • Multiple fatalities • Damage to construction work • Damage to property • 1st Aid Treatment cases • Breakdowns due to trucks being stuck in thick sand • Project delays • Slippery/sandy roads could result in incidents/accidents 	Likely to occur	High	<ul style="list-style-type: none"> • Display clear visible speed limits signage • Trained and licensed vehicle operators • Roadworthy vehicles • Trained and observant employees • Sufficient supervision • Enforce adherence to traffic rules • Tested and operational communication tools/equipment • Trained flag operators available in designated areas if required • Well maintained gravel roads • Induct employees to farm speed limits • Maintain sandy roads – regular grading 	<ul style="list-style-type: none"> • Informed vigilant law and safety abiding employees, pedestrians, contractors and visitors • No injury • No bodily harm • No property damage • No equipment damage • No animal harm • No vegetation damage 	Unlikely to occur	Low
1.4. Equipment, Machinery & Material	<ul style="list-style-type: none"> • Incorrect selection of plant machinery, material and or equipment 	<ul style="list-style-type: none"> • Unintended wrong use, handling, stacking and storage 	Likely to occur	High	<ul style="list-style-type: none"> • Competent trained employee or supervisor for 	<ul style="list-style-type: none"> • Correct supply and receipt of goods 	Unlikely to occur	Low

Reception (within designated areas)	<ul style="list-style-type: none"> • Unauthorised suitable / incorrect storage • Poor lighting and visibility receipt of equipment, machinery and material • Receipt of defective equipment, machinery and material • Poorly inspection for compliance of safety and quality of equipment, machinery and material • Insufficient documentation • Untrained incompetent personnel • Incorrect storage and stacking of equipment, machinery and material 	<ul style="list-style-type: none"> • Defective equipment, machinery and material • Load collapse/drop to lower level • Injury and bodily harm • Loss of time, re-ordering and leap time • 1st Aid Treatment Care • LTI • Project standing time 		<ul style="list-style-type: none"> • ordering and receipt of goods • Visual inspection for correct and compliance of safety and quality of equipment, machinery and material • Good knowledge of applicable documentation and control • Good communication ability • Appointed stacking of articles supervisor • Lighting Inspection and regular maintenance • Proper supervision & control • R/A training 	<ul style="list-style-type: none"> • Safety and quality compliance met • Records maintained • Good secure stable stacking and storage • No injuries/ bodily harm • No property damage/loss 		
1.5. Heavy Equipment, Machinery & Material Movement - Movement on property	<ul style="list-style-type: none"> • Operating routes not planned, or identified or demarcated • No speed limit signage • Vehicle height limits and load height limits not displayed • No marking and signpost of power lines, overhead wires/poles, bridges, overhead cranes, equipment • No displayed number of vehicles allowed on site not established • Reversing on site, reversing flashing beacon, alarms, sirens, convex mirrors • No one-way traffic flow and direction controls • Dedicated offloading area • Insufficient offloading 	<ul style="list-style-type: none"> • Poor communication with operators, users those affected • Confusion and uncertainty • Accidents • Electrocutation • Personal injury • Personal Bodily harm • Fatality • Damage to property • Uncontrolled load • Load collapse • Loss of time • Electrocutation • Breakdowns, plant, equipment • Environmental damage • Poor communication 	Likely to occur	High <ul style="list-style-type: none"> • Identify and communicate communication Contractor Code of Conduct Rules • Erect clear visible signage for warning and instruction • Clearly communicate safety adherence and requirements • Unauthorised areas clearly zoned off • Restricting worker presence to a suitable distance • Promote continuous communication with and to relevant persons. 	<ul style="list-style-type: none"> • Informed vigilant law and safety abiding employees, and operators • Operational communication • No fatality • No injury • No bodily harm • No property damage • No equipment damage • No negative environmental effects 	Unlikely to occur	Low

	<ul style="list-style-type: none"> signage and communication Dedicated demarcated pedestrian walkway and entry No banks men/signaller Clear readable signage High visibility clothing No safe system work plan Roll over protection systems Regular Inspection and maintenance of equipment Licensed and certified equipment Incorrect Lifting equipment Defective tools and equipment Lifting equipment failure Trained, licenced and competent operators Falling equipment/objects or loads Heavy & Unsteady loads Suspended loads Adverse weather conditions Theft of equipment and material Operators fatigue Poor motivation/instruction No or inadequate inspections Incompetent operators Unlicensed equipment Uncertified tools and material 	<ul style="list-style-type: none"> with operators, users those affected Confusion and uncertainty Accidents Electrocution Personal injury Personal Bodily harm Fatality Damage to property Uncontrolled load Load collapse Loss of time Electrocution Breakdowns, plant, equipment Environmental damage 			<ul style="list-style-type: none"> Conduct regular inspections and maintenance and maintain records. Obtain licenses and certification where required Rest at regular intervals to prevent fatigue Training conducted on all required safety tasks Safe Operating procedures (SOP's) including "No lifts / people transport on equipment" Trained operators on alternatives to working during or not adverse weather conditions. Only appoint trained, skilled, experienced and competent persons No movement, other than in construction work areas Maximum speed limit is 15km/h Inform Drake & Scull personnel if vehicles travel off-site for other purposes 	<ul style="list-style-type: none"> Controlled compliant operations Informed vigilant law and safety abiding employees, and operators Operational communication media No fatality No injury No bodily harm No property damage No equipment damage No negative environmental effects Controlled compliant operations 			
2. SITE PREPARATIONS									
2.1. Temporary Water Tank Assembly	<ul style="list-style-type: none"> Water tank rupture/leakage Inadequate supporting Water lines are blocked & dirty 	<ul style="list-style-type: none"> Ground can become soft Tank burst/Collapse of the water tank 	Good chance to occur	Moderate	<ul style="list-style-type: none"> Daily visual inspections on tanks and all switches Correct and replacement of 	<ul style="list-style-type: none"> No Incidents, accidents, injury, bodily harm, property damage. 	Likely to occur	Low	

	<ul style="list-style-type: none"> All switches not inspected Incorrect connections to boreholes 	<ul style="list-style-type: none"> Water spillage Slipping and falling No fresh water available Faulty switches 1st aid treatment cases Project standing time 			<ul style="list-style-type: none"> defective tank and faulty switches Spill containment tools and equipment in place Alternative fresh water sources available 	<ul style="list-style-type: none"> Tools equipment and water resources available 		
2.2. Vegetation Clearance (Mechanical clearance of rocks, boulders, vegetation, hedges, shrubs and trees as agreed with environmental authorities & farm/project management)	<ul style="list-style-type: none"> Sharp edges Domestic waste Unknown hazardous items such as needles and broken glass could be present in the domestic/household waste Poisonous plants Dangerous animals Uneven surfaces Dust exposure Tools and equipment Mobile equipment 	<ul style="list-style-type: none"> Cuts and lacerations Slips, trips and falls Poison reactions Vehicle/worker accidents Injury and bodily harm Respiratory infections Lung disease or allergic reactions Eye irritation Skin irritation 1st aid treatment cases LTI Project standing time 	Good Chance to occur	High	<ul style="list-style-type: none"> Training on SOP Training on mobile equipment Raise awareness on Vegetation Informed vigilant employee Correct supply and application of PPE Apply good housekeeping Safeguard tools' moving parts Pre-assessment of areas to be cleared 	<ul style="list-style-type: none"> No Incidents, accidents, injury, bodily harm, property damage or environmental damage of indigenous vegetation 	Unlikely to occur	Low
2.3. BLASTING (If required – Not identified to be incurred)	<ul style="list-style-type: none"> No BIC (Blaster in Charge) On-site uncontrolled blasting explosive storage No pre communication of blasting plan, procedure, method, roles and responsibility to team Lack of blasting communication dates and signage to those affected Flying material, air over-pressure, or gases from an explosion Lack of suitable PPE; No eye, ear and respiratory protection Using compressed air to clean the dusty area Blasting in adverse weather conditions No restricted area barricading signage 	<ul style="list-style-type: none"> Un-safe blasts, when no one is in control to take charge, give orders to execute the blast safely. Un-controlled, incompatible explosive storage can result in an explosion Human exposure to gases released from an explosion can cause Injuries / bodily harm such as noise, vibration dangers to employees and surrounding communities Property and equipment damage Incorrect/Insufficient PPE 	Good chance to occur	High	<ul style="list-style-type: none"> Safely execution of the blasting plan Off-site storage of explosives Blasting date & signage displayed, Informed and PPE protected employees and communities Water trucks spray water to suppress dust Inspection of weather conditions - favourable no wind/rain before blasting Eating areas provided Clear signage of restricted zones R/A Training 	<ul style="list-style-type: none"> No accidents, injuries, bodily harm No complaints from surrounding areas No unnecessary damage to existing fauna & flora 	Likely to occur	Low

	<ul style="list-style-type: none"> • Non removal of blasting material hazards and clearing of area • Personal eating where blasting took place 	<ul style="list-style-type: none"> • Improper dust suppression • Incompatible weather conditions • 1st aid treatment cases • Medical treatment cases & fatalities 			<ul style="list-style-type: none"> • Blasting permits 			
2.4. Foundations Vibrating concrete. (Casting concrete for the foundations)	<ul style="list-style-type: none"> • Concrete splash. • Operating the poker • Workers falling due to: not using safety belt, insufficient scaffold planks, workers receiving concrete whilst standing on rebar. • Concrete coming in contact with the skin. 	<ul style="list-style-type: none"> • Eye injuries • Hand injuries • Injury to body; Disabling and even fatal. • HCS poisoning • Medical Treatment cases • 1st aid cases • Project standing time 	Likely to occur	High	<ul style="list-style-type: none"> • Firm walkway and stable ramp with edge protection.. • Skills training & toolbox talk. Wear correct PPE. • Skills training & toolbox talk. Wear correct PPE. • Wear and install correct PPE and scaffold check list done. • Wear correct PPE • R/A training 	<ul style="list-style-type: none"> • No injury/damage to work force or equipment during concrete pouring for foundations 	Unlikely to occur	Medium
2.5. Fire fighting	<ul style="list-style-type: none"> • Inadequate and wrongly placed fire equipment can cause a delay in dealing with fire should it occur. • Non-availability of equipment. • Untrained personnel using wrong type of equipment to extinguish the fire. Delays in searching for fire extinguishers. • Electrocution. Increased spread of fire. Explosions. • Fire alarm not functional or inaudible. • Fire can occur. • Access blocked and people trapped inside; Fire fighting team not able to obtain access. • Fire can occur in the bins. • Shortage or non-operation of 	<ul style="list-style-type: none"> • Fire getting out of control injuries to persons and damage to property. • Loss of life and extensive damage property (veld fires). • Injury to employees and damage to property. • Fatality/Injury to persons and damage to property. • Injury to people and damage to property. • 1st aid cases • Medical treatment cases 	Likely to occur	High	<ul style="list-style-type: none"> • Adequate fire equipment to be provided and placed at suitable locations. • Monthly checklist of all equipment. • Provide training and have fire drills periodically. • Trained personnel. • Monthly checklist. • Induct workers on usage and storage of combustible materials. • Store material in demarcated areas. • Ash trays and waste bins to be emptied daily. Induct all personnel. • Supervisor to 	<ul style="list-style-type: none"> • No injury/damage to work force or equipment • No spreading of veld fires causing damage to property 	Unlikely to occur	Low

	<p>fire fighting equipment in the case of fire.</p> <ul style="list-style-type: none"> • Overcrowding at exit points during fire. 				<p>enforce.</p> <ul style="list-style-type: none"> • Fire escape routes and assembly points to be determined and clearly marked • Designated smoking areas 			
2.6. Ripping	<ul style="list-style-type: none"> • Untrained incompetent Operator • Unlicensed uncertified mobile equipment/moving machinery • Poor operator visibility • Uneven surfaces / unstable • Operating on excavation edges • Obstructions when operating – people, equipment, materials • Adverse weather conditions • Flooded/Wet/soft ground-slippery 	<ul style="list-style-type: none"> • Unauthorised entry safety obstruction, exposure to moving equipment • Serious Injury and bodily harm • Fatal-struck by moving equipment • Moving equipment struck in flooded/wet/soft ground • Release of vehicle toxic emissions-inhalation, ingestion, respiratory irritation • Slip and fall on ground • Improper communication • Poor visibility for moving equipment operator 	Likely to occur	High	<ul style="list-style-type: none"> • Restrict unauthorised entry • Erect visible barricading and signage • Limit moving equipment operation • Communicate moving equipment right of way, clear area from people. • Apply high visible PPE • Training and awareness • Use of sloping or benching in the excavation when ripping • Use water pumps remove floods & ground water • Banks man available at all times with machinery operation 	<ul style="list-style-type: none"> • No injury/damage to work force or equipment 	Unlikely to occur	Medium
2.7. Temporary electrical installations (for construction work purposes)	<ul style="list-style-type: none"> • Use of Generators as supply of electricity • Operating generators indoors • In contact with generators with wet hands • Connect appliances to the generator using heavy-duty extension cords that are specifically designed for outdoor use • No fire precautions in place • Generator overheating 	<ul style="list-style-type: none"> • Electrical shock • Electrocutation • Fire / burns • Injury / Bodily harm • Trips, slip and fall • Medical treatment cases • 1st aid treatment cases • Project standing time due to incident investigation 	Likely to occur	High	<ul style="list-style-type: none"> • Trained competent employee/user • Inspect Generators & complete checklist or temporary installation • Restrict Generators working indoors • Make use of hand gloves and suitable PPE • Ensure appliances 	<ul style="list-style-type: none"> • No injury/damage to work force or equipment • No project delays due to insufficient power supply 	Unlikely to occur	Medium

	<ul style="list-style-type: none"> • Electrical appliances not insulated, cuts & openings • Incorrect connections of temporary electrical supply (DB Boxes) • No correct earthing or protection • No proper lock-out/tag-out 				<ul style="list-style-type: none"> • does not exceed generators power • Fire extinguishers available • Inspect all electrical appliances daily • Sufficient operational fire fighting equipment on site • Lock-out / tag-out • COC for temporary electrical installation by certified electrician 			
2.8. Temporary Facilities Installation (Site camps for contractors)	<p>Inadequate or None of the following in place:</p> <ul style="list-style-type: none"> • No water service and distribution • No Sanitary facilities • No Drinking water for workers • Inadequate Water disposal services • No Waste disposal services, or poor waste management • Construction aids and miscellaneous services • Inappropriate site access, gates not lockable • No Security protection or keeping wild animals out of facilities • No Fire protection • Poor Telephone availability (cell) • Insufficient fencing 	<ul style="list-style-type: none"> • No water service – production delay • No sanitary – Unhealthy and unhygienic • No drinking water – thirst dehydration • No heating system – thermal (cold) stresses frost bite • No ventilation – thermal (heat) stresses, fatigue unproductivity • Water spillage ground contamination and soil pollution • Waste illegal dumping • Soil/ground pollution • Unsafe/secure working area • Access to wild animals 	Likely to occur	Moderate	<ul style="list-style-type: none"> • Ensure water for human consumption, hand wash, sanitation and construction works. • Suitable heating system in cold conditions and well ventilated areas for work and rest • Suitable used-water catch-up points and waste segregation containers at identified points for later disposal by an approved contractor to an approved legal waste disposal site, off site • Provide all other required construction aids and services (first-aid, PPE, Tools, equipment and materials. • Conduct regular inspections and maintenance • Site camp fencing according to client 	<ul style="list-style-type: none"> • No injury/ damage to work force or equipment • No pollution to sensitive area • No spillage • Vegetation conservation • Separation of workers/ work activities & wild animals 	Unlikely to occur	Low

					<ul style="list-style-type: none"> safety specification Maintain records Provide suitable safety and security service, Access control, emergency equipment and suitable trainings to perform required tasks. Maintain emergency equipment as required by legislation 			
3. EARTH WORKS								
3.1. Excavations	<ul style="list-style-type: none"> Inadequate barricading around excavations No signage around excavations Falls from height into excavations Struck by plant or machinery Unsafe transport of tools to elevated position of works Struck buried electrical cables, gas pipelines sewage or water pipes. Excavation flooding, groundwater, No Banks man available at all times with machinery operation Striking unknown underground services. Working in the wrong place Moving machinery Soil stacked too close – may fall back into excavation Excavation collapse Persons may walk into excavation Un-safe work may proceed if excavation work is not 	<ul style="list-style-type: none"> Unauthorised entry safety obstruction, exposure to moving equipment Serious Injury and bodily harm Fatal-struck by moving equipment Falls of objects into excavations employee contact Electrical shock Release of toxic gas and toxic waste/substance; inhalation, ingestion, skin absorption, irritation Slip and fall inside flooded excavation Improper communication and poor visibility for moving equipment operator Damage to underground services Unwanted costs 	Likely to occur	High	<ul style="list-style-type: none"> Restrict unauthorised entry Erect visible barricading and signage Limit moving equipment operation Communicate moving equipment right of way, clear area from people. Provide suitable tool bags Apply high visible PPE Training/Awareness re: excavation area, buried cables pipes etc. (R/A) Use of sloping or benching in the excavation if required Use water pumps remove floods & ground water Banks man available at all times with 	<ul style="list-style-type: none"> No injury/ damage to work force or equipment 	Unlikely to occur	Medium

	checked timeously	<p>working in wrong area/place</p> <ul style="list-style-type: none"> • Severe Injury to workers/Un-roadworthy vehicles-damage • Lost time, damage and possible injury/fatal • 1ST aid treatment cases • Disabling injuries • Project standing time 			<p>machinery operation</p> <ul style="list-style-type: none"> • Obtain excavation permit, site plans, and layouts of any underground services that may be in the area of work. • Only trained competent, licensed operators, • Banks-man in place • Toolbox talks • Tools/Equipment and soil stored 1m and further from excavation • Ensure no cracks in side walls. Sides to be stable • Ensure barricades in place 1 meter away from edge short-term, if longer than 24hours – solid barricade required • A trained competent person to ensure that all the correct procedure are followed and implemented before the start of any excavation • Trained competent person to read and check drawings/layouts etc. • Trained competent operators appointed • Machines checked daily • Daily toolbox talks 			
3.2. Trenching (Water supply; storm water;	<ul style="list-style-type: none"> • Long deep hole with steep sides • Collapse of trench walls 	<ul style="list-style-type: none"> • Serious Injury / Bodily harm • Exposure to 	Likely to occur	Moderate	<ul style="list-style-type: none"> • Authorised entry to trained/competent employees 	<ul style="list-style-type: none"> • No injury/ damage to work force or 	Unlikely to occur	Low

<p>electrical supply)</p>	<ul style="list-style-type: none"> • Underground services not located/unknown. • Soil on edge of trenches • Unauthorised entry into • Trench not properly shored, sloped or benched • Entry into unprotected trenches • Workers not fully protected within a trenched shield. • Shoring not positioned and fixed from above, • Using soft wood and not using F8 grade hard wood. • No warning of danger when inside trench • Not wearing hard hats inside trenches • Unnecessary up and down climbing in trenches. • No support system, to triggering a trench collapse. • Not using industrial grade portable ladders to gain access to the trench floor. • Working alone in a trench. • Not noticing/ checking changing condition of soil surrounding trenches • Not checking walls for signs of earth fretting, slipping, slumping or ground swelling. • Not repairing trench walls • Water, ground/flooding inside trenches • Incorrect sloping • Inadequate shoring • Possible dangers not evaluated 	<p>underground electrical cables, gas lines, water and sewage and telecommunications cables</p> <ul style="list-style-type: none"> • Electrical live energy, toxic gas and sewer release, flooding, wet ground • Target organs: body exposed to wet cold condition, affecting the respiratory, eyes, skin, body, causing allergic reactions and illnesses • Serious Injury / Bodily harm • Exposure to underground electrical cables, gas lines, water and sewage and telecommunications cables • Electrical live energy, toxic gas and sewer release, flooding, wet ground • Target organs: body exposed to wet cold condition, affecting the respiratory, eyes, skin, body, causing allergic reactions and illnesses • Lost Time Injuries • Project standing time due to investigation of incidents 			<ul style="list-style-type: none"> • Locate under- ground services using updated approved site plans drawing and municipal consultation • Make sure soil is being kept at least half a meter back from the edge of trenches • Never allow workers to enter a trench which is greater than 1m deep unless it has been safely battered back, or it has been properly shored or the workers are fully protected within a trenched shield. • Shoring should be positioned and fixed from above, never from below. • All timber used in ground support should be at least F8 grade hard wood. • Never use soft wood this can fail suddenly without warning, where as hard wood will start to creak loudly when it becomes overloaded. • This is warning to workers to leave the trench immediately • Always wear hard hats inside trench • Never allow workers to climb up and down 	<p>equipment</p>		
----------------------------------	--	---	--	--	---	------------------	--	--

					<p>the soldier sets used in trench shoring, because they can loosen or damage the support system, triggering a trench collapse.</p> <ul style="list-style-type: none"> • Make sure industrial-grade portable ladders are used to gain access to the trench floor. • Never allow anyone to work alone in a trench • Make sure there is always another person close by who can provide help or get help if necessary. • The condition of soil surrounding trenches and shafts can change quickly due to the soil drying out, changes in the water table or water saturation of the soil. • Make sure the soil condition and the state of shoring, bettering and trenches walls is frequently checked for signs of earth fretting, slipping, slumping or ground swelling. • Where necessary, repair the trench or strengthen the shoring system from above before allowing work below ground to continue 			
--	--	--	--	--	---	--	--	--

					<ul style="list-style-type: none"> • Prevent Caught-In or Between • Make sure the trench is protected either by sloping, shoring, and benching or trench shield systems 			
3.3. Filling/back filling of trenches	<ul style="list-style-type: none"> • Workers can walk behind machine and get run/bump over. • Uneven platform • Working too close to excavation 	<ul style="list-style-type: none"> • Serious injury and possible fatality • Slip and fall=injury • Machinery /equipment may fall into excavation • 1st aid treatment cases • Medical treatment cases • Lost Time Injuries • Project standing time due to incident investigation 	Likely to occur	Moderate	<ul style="list-style-type: none"> • Trained competent persons • Correct, PPE (hardhats, safety shoes, gloves, overalls and hearing protection. • Not to use untrained persons • Keep equipment and machinery 3 meters away from excavation • Daily toolbox talks explaining hazards of working around heavy moving machinery. • Trained person in lifting equipment • Barricade area off 	<ul style="list-style-type: none"> • No injury/ damage to work force or equipment 	Unlikely to occur	Low
3.4. Foundations (piles and slabs)	<ul style="list-style-type: none"> • Equipment vibrations • Concrete splash • Not wearing the correct PPE. • Lack of supervision • Skin absorption of materials • Nails of timber not being de nailed safely • Formwork injury 	<ul style="list-style-type: none"> • Serious injury / bodily harm (Eyes, arm dislocating/foot) • Serious illness/diseases (Skin-dermatitis) • Respiratory irritation/disease • 1st aid treatment cases • Medical treatment cases 	Likely to happen	High	<ul style="list-style-type: none"> • Daily inspections • Correct PPE • Communicate at all times • Complete formwork registers • Toolbox talks 	<ul style="list-style-type: none"> • No injury/ damage to work force or equipment 	Unlikely to occur	Low
3.5. Batch Concrete plant assembly and	<ul style="list-style-type: none"> • Not trained incompetent supervisor not appointed • Manufacturer requirements for placement, erection and design of a batch plant not 	<ul style="list-style-type: none"> • Unauthorised entry and plant operation • Accidents and Incidents • Fatal 	Likely to happen	Moderate	<ul style="list-style-type: none"> • Appoint in writing a trained and competent operator as supervisor • Implement 	<ul style="list-style-type: none"> • No injury/ damage to work force or equipment • No injury or 	Unlikely to occur	Low

<p>operations (if required)</p>	<p>followed.</p> <ul style="list-style-type: none"> • Stop and start devices to start and stop a batch plant are provided but not easily accessible and no prevention for accidental starting. • Inadequate machinery and plant selection for the task • No safety guards/doors/covers in place against human protection of dangerous moving parts of a mixer • Unauthorised access, removal or modification to guards and safety equipment • Instruction by unauthorised person w.r.t batch plant • Employees allowed in the BP are un aware of all the dangers involved in the operation of BP and not conversant with the precautionary measures to be taken in the interest of health and safety. • Incompetent person operates BP machinery. • No precautionary measures taken prior entering Confined spaces entering any silo. • No proof of repairs or maintenance to a batch plant or equipment • Defective Lifting machines and lifting tackle in operation • Insufficient precautionary control measures for electrical equipment in explosive atmospheres, such as when entering a silo, 	<ul style="list-style-type: none"> • Serious Injury/ Bodily harm/illness • Property damage • Unauthorised entry and plant operation • Accidents and Incidents • Fatal • Serious Injury/ Bodily harm/illness • Property damage 			<p>environmental management plan</p> <ul style="list-style-type: none"> • The placement and erection of a batch plant complies with the requirements set out by the manufacturer and that such plant is erected as designed • Dust control • That all devices to start and stop a batch plant are provided and that these devices are placed in an easily accessible position; and constructed in such a manner as to prevent accidental starting. • That machinery and plant selected is suitable for the task • That all dangerous moving parts of a mixer are placed beyond the reach of persons by means of doors, covers or other similar means. • No person is permitted to remove or modify any guard or safety equipment • relating to a batch plant, unless authorised to do so by the appointed supervisor • All persons authorised to operate the batch plant are fully aware of all the 	<p>damage to machinery or property</p> <ul style="list-style-type: none"> • Monitoring potential spillage & environmental damage & soil pollution • Controlling all forms of pollution 		
--	---	--	--	--	---	--	--	--

					<p>dangers involved in the operation thereof; and conversant with the precautionary measures to be taken in the interest of health and safety.</p> <ul style="list-style-type: none"> • No person supervising or operating a batch plant shall authorise any other person to • operate the plant, unless such person is competent to operate such machinery. • That all precautionary measures as stipulated for confined spaces when entering any silo. • Maintain all records of any repairs or maintenance to a batch plant and that it is made available, on site, to an inspector, client, client's agent or employee upon request. • That all lifting machines and lifting tackle used in the operation of a batch plant complies with the applicable legislation 			
<p>3.6. Road preparation (including paved</p>	<ul style="list-style-type: none"> • Falls from height, • Moving vehicles/machinery • Excavation 	<ul style="list-style-type: none"> • Fatal worker being hit by SME • Electrocutation/ 	<p>Likely to occur</p>	<p>High</p>	<ul style="list-style-type: none"> • Trained and competent employees 	<ul style="list-style-type: none"> • No injury/ damage to work force or 	<p>Unlikely to occur</p>	<p>Low</p>

access roads)	<ul style="list-style-type: none"> • Electrical works • Struck by falling objects • Manual handling • Exposure asbestos, solvents and noise • Falling bricks • Trip & fall hazards • Improper manual handling injuries • No proper offloading of paved bricks • Damage to material or injury to persons • Man/Machine interface 	<ul style="list-style-type: none"> • overhead lines • Serious Injury / Bodily harm • Serious illness/ disease • 1st aid treatment cases • Medical treatment cases • Back injuries due to poor manual handling • Project standing time • Hand & foot injuries – laying of kerbing 			<ul style="list-style-type: none"> • Licensed and certified operators, vehicles and moving equipment • Trained on SOP's • Signage and warnings clearly erected • Never position yourself between moving and fixed objects • Wear high-visibility clothes near equipment/vehicles • Handling techniques and safe lifting equipment / devices used • Suitable PPE application 	equipment			
4. CONSTRUCTION WORKS: TOP STRUCTURES									
4.1. Soil poisoning; foundation walls; filling in furrow and ramming	<ul style="list-style-type: none"> • Wrong application of insecticides • Contact with harmful material • Inadequate control or measure of PPE • Insufficient supervision • Direct contact with pesticides 	<ul style="list-style-type: none"> • Severe skin diseases when in contact or inhalation of pesticide fumes • 1st aid medical treatment cases • LTI • Project lost time • Bodily harm • Serious illness due to side effects when in contact or inhalation 	Likely to happen	High	<ul style="list-style-type: none"> • Direct supervision & control • Application by registered/approved pesticide specialist • Correct PPE for standing staff/ employees • R/A training • SWP for task to be communicated • Communicate MSDS for the type of pesticide to be applied • Implement environmental management plan • Pre-start checks on tools & application equipment 	• No injury/ damage to work force or equipment	Unlikely to occur	Low	
4.2. Concrete	• Non-compliance with CR 10	• Non-conforming	Likely to	High	• Full compliance with	• No injury/	Unlikely to	Low	

<p>formwork & re-enforcement</p> <ul style="list-style-type: none"> - Column bases - Retaining walls 	<p>when erecting Formwork and Support work (F&S work)</p> <ul style="list-style-type: none"> • Inadequate designed, erected, supported, braced (F&S work) structures • Not checking and ensuring that the (F&S work) can withstand the load. • (F&S work) concrete required strength not achieved. • Un safe access to the structure • Inadequately trained employees • Unstable foundations • Un notice/un-removed damaged or weakened (F&S work) • No adequate supervision • Inadequate manual handling 	<p>Formwork and Support work (F&S work) is illegal with risk of collapsing</p> <ul style="list-style-type: none"> • Fatal / serious injury / Bodily harm • Property damage • 1st aid treatment cases • Medical treatment • Back injuries due to incorrect manual handling • Lost Time Injuries • Project standing time due to incident investigation & re-training 	<p>happen</p>		<p>CR 10 when erecting Formwork and Support work (F&S work)</p> <ul style="list-style-type: none"> • Adequate designed, erected, supported, braced (F&S work) structures • Check and ensure that the (F&S work) can withstand the load. • (F&S work) to remain intact to ensure concrete required strength is achieved. • Provide safe access to the structure without compromising safety and quality • Train employees • Correct PPE for task • Ensure foundations are stable. Inspected by Engineer & signed off • Immediately remove damaged or weakened (F&S work) • Direct supervision • Promote safe work • Proper propped slabs 	<p>damage to work force or equipment</p>	<p>occur</p>	
<p>4.3. Compaction</p>	<ul style="list-style-type: none"> • Contact with compactor • Hand arm vibration • Hearing loss • Contact with moving machinery • Noise, Fumes, Dust, wet areas 	<ul style="list-style-type: none"> • Serious injuries • Possible eye irritation • Vibration, Loss of hearing • Inhalation, Intoxication Dizziness • Slipping and Falling • 1st aid treatment cases • Lost Time Injuries 	<p>Likely to happen</p>	<p>Moderate</p>	<ul style="list-style-type: none"> • Trained competent operators • Erect slippery area signs • Raise awareness daily • Barricade area • Correct application of PPE 	<ul style="list-style-type: none"> • No injury/ damage to work force or equipment 	<p>Unlikely to occur</p>	<p>Low</p>

					<ul style="list-style-type: none"> • Training • Daily toolbox talks • Regular inspection • Erection of signs 			
4.4. Welding	<ul style="list-style-type: none"> • Untrained Incompetent operator • Welding near flammable materials substances • Inadequate screening • Defective Oxygen and acetylene cylinders • Not closing valves on unused cylinders • Cutting torches not equipped with flashback arrestors on both the torch and gauge sides of each hose. • Oxy-acetylene assemblies not provided with a bracket for attaching a fire extinguisher, not numbered or not identifiable. • Fire extinguisher not movable as near as practicable to the point of fire, where cutting/welding work is in progress. • Not preventing fires injuries when working in elevation or multi-levels, to persons below. • Not using a welding blanket to contain sparks or welding slug. • Not placing a Spotter or Flagman at all affected levels. • Not obtaining authorisation to do hot work, by completing a hot work permit before any flame cutting or welding will be done • Poor welding ergonomics and insufficient PPE 	<ul style="list-style-type: none"> • Open flames • Flying sparks that are able to ignite any flammable gases and vapours; and • The hot work itself may produce toxic fumes and gases. • Personal exposure to fumes and gases, heat, noise, radiation, as well as, musculoskeletal injuries (MSI's), such as strains and sprains • 1st aid treatment cases – burn wounds • Sparks causing fires to structures 	Most likely to occur	High	<ul style="list-style-type: none"> • Arc welding and torch cutting is only to be carried out by trained competent person. • No welding or cutting will be allowed anywhere near any flammable materials or substances. • Adequate screening shall be provided where arc welding is in progress. • Oxygen and acetylene valves on the cylinders must be closed when not in use. • All cutting torches shall be equipped with flashback arrestors on both the torch and gauge sides of each hose. • All oxy-acetylene assemblies must be provided with a bracket for attaching a fire extinguisher and numbered or identifiable. • The fire extinguisher shall be removed from its holder and brought as near as practicable to the point of fire, while any cutting/welding work is in progress. • When working in elevation or multi- 	<ul style="list-style-type: none"> • No injury/ damage to work force or equipment 	Unlikely to occur	Low

					<p>levels, adequate precautions must be taken to prevent fires or injuries to persons below. These include:</p> <ul style="list-style-type: none"> • Use of a welding blanket to contain sparks/welding slug. • A hot work permit shall be completed before any flame cutting or welding will be done • Ensure suitable work environment, indoor or outdoor, good quality of natural and or mechanical exhaust ventilation, roof exhaust fans and wall fans. • Supply and application of suitable respiratory, eye, and skin/clothing PPE 			
4.5. Scaffolding Installations	<ul style="list-style-type: none"> • Working in unsafe elevated position • Not wearing and use of personal fall arrest equipment. • No installation and maintaining perimeter protection. • No covering and securing of floor openings and label floor opening covers. • Use ladders and scaffolds unsafely • Not implementing fall protection plan • No secure footings for scaffolding 	<ul style="list-style-type: none"> • Fatal incidents • Serious Injury- person fall from heights • Bodily harm • Equipment falling • Collapse of scaffold • 1st aid treatment cases • Medical treatment cases • Lost Time Injury • Project standing time due to incident investigation 	Likely to happen	High	<ul style="list-style-type: none"> • Trained competent scaffold erectors, operators and scaffold inspectors Training (W@H) • Pre-use inspections & communicate fall protection plan • Erection of relevant signs and barricading • Trained competent persons • Safety harness (fall arrest equipment) • Training competency (working at heights) 	<ul style="list-style-type: none"> • No injury/ damage to work force or equipment 	Unlikely to occur	Medium

	<ul style="list-style-type: none"> • Scaffolding structures not erected according to SANS requirements 				<ul style="list-style-type: none"> • Daily toolbox talks & training on R/A • Regular inspections • Erection of relevant signs (tagging/safe/unsafe) • Wear and use personal fall arrest equipment. • Install and maintain perimeter protection. • Cover and secure floor openings and label floor opening covers. • Use ladders and scaffolds safely (only aluminium ladders allowed) • Scaffold inspection by competent inspector and signpost declared safe to use/work with tag 			
4.6. Brickwork (Masonry) - Laying of bricks using temporary work platforms - Superstructures - Rubble walling - Stone aprons	<ul style="list-style-type: none"> • Sand / Cement being mixed incorrectly • Materials / brick and equipment unsafe handling practices • Unsafe work platforms when laying bricks above 1.5m • Poor weight distribution on work platform – no adequate SWL • Falling bricks • Collapsing of work platform • No drop zone, bricks falling on workers below • Poor handing of brick material or stones leading to hand injuries • No sufficient PPE (gloves) • No proper fall protection plan 	<ul style="list-style-type: none"> • Injury / bodily harm using equipment and material • Exposure, inhalation, ingestion, contact with eyes and skin/cement powder • Property damage • Falling objects causing serious injuries • 1st aid treatment cases • Medical treatment cases • Lost Time Injuries • Project lost time due to stoppages 	Likely to happen	High	<ul style="list-style-type: none"> • Competent persons (bricklayers) • All required PPE and correct application • No material must be handled safely and not be thrown from one worker to another • Regular inspection of tasks & equipment • Toolbox talks; R/A & SWP training • Erection of construction work in progress signs • Correct designed temporary work platforms to be used 	<ul style="list-style-type: none"> • No injury/ damage to work force or equipment 	Unlikely to occur	Low

	<p>implemented</p> <ul style="list-style-type: none"> • Slip, trip & fall hazards due to poor housekeeping 				<ul style="list-style-type: none"> • Fall protection plan to be implemented • Barricade “drop zone” • Proper housekeeping: Remove potential trip & fall hazards after each work shift 			
<p>4.7. Electrical Installations (Temporary & permanent)</p>	<ul style="list-style-type: none"> • Defective equipment • Untrained persons • Exposed wires • Loose untidy wires • Defect tools (wrong tools for task) • Use the right tool for the right job • Untidy substandard electrical cables • Unqualified electrical installation personnel • No proper LOTO applied and implemented could lead to electrical shock • DB Boards not locked out. No control could lead to serious incidents • Unsafe chasing in walls for electrical conduit 	<ul style="list-style-type: none"> • Electrical Shock (fatality) • Electrical Fire • Unauthorized operating • Tripping and falling • Burn incidents • Medical treatment cases • Project standing time due to incorrect installations 	Likely to happen	High	<ul style="list-style-type: none"> • Qualified electrician to be appointed • Check all electrical tools to be standard prior to the task • No exposed wires • No open connections (LOTO to be implemented) • No tangled extension cords • No overload of adapters • No temporary hand-made connections • Use only standard electrical tools. • Trained and competent persons • Electrical inspections to be done before work commence • COC to be issued after installations • Electrical inspection list filled in prior & during task 	<ul style="list-style-type: none"> • No injury/ damage to work force or equipment 	Unlikely to occur	Medium
<p>4.8. Security System Installation (Poles, Cables Camera)</p>	<ul style="list-style-type: none"> • Damage to fencing by animals and intruders • Unauthorised access of people and access • Vandalism of fencing and equipment • No Anti-intrusion software • No Remote control system 	<ul style="list-style-type: none"> • Vandalism • Property and equipment damage • Theft of cables and equipment • Incorrect / unreliable readings • Communication 	Most likely to occur	High	<ul style="list-style-type: none"> • Install security systems to prevent damages and plant downtime, unauthorised entry, vandalism and theft • Anti-intrusion software to detect 	<ul style="list-style-type: none"> • No injury/ damage to plant or equipment 	Unlikely to occur	Low

	<ul style="list-style-type: none"> No on-site security No camera system in place 	<ul style="list-style-type: none"> breakdown Production breakdown 			<ul style="list-style-type: none"> moving objects but recognise false alarms 			
4.9. Carpentry & Joinery <ul style="list-style-type: none"> Laminate finishing Hardwood frame installation & hanging of doors 	<ul style="list-style-type: none"> Wrong use of cutting/ grinding tools Incorrect use of PPE Wrong tools for job Inadequate offloading of wooden doors & material Unsafe manual handling No proper supervision could lead to serious injuries Wrong work methods delaying works 	<ul style="list-style-type: none"> Cuts to hands (serious to fatal) Serious to moderate consequences due to unsafe acts Damage to property/ equipment & material Medical treatment cases 1st aid treatment cases Project standing time due to incorrect methods & incident investigations 	Likely to occur	High	<ul style="list-style-type: none"> Correct carpentry tools for task R/A training SWP applied & communicated Pre-start checks on all electrical power tools; cutting machines Correct PPE for task Direct supervision Only trained carpenters to be used Medicals for all workers 1st aid supply 	<ul style="list-style-type: none"> No injury/ damage to plant, equipment or property 	Unlikely to occur	Low
4.10. Ceilings; partitioning and access flooring <ul style="list-style-type: none"> Fire barrier installation Suspended ceilings 	<ul style="list-style-type: none"> Falling material or equipment Unsafe manual handling when lifting ceiling boards No proper supervision leading to injuries Inadequate PPE for task Unsafe working at heights Falling from heights while installing suspended ceilings 	<ul style="list-style-type: none"> Moderate to serious injuries Fall incidents Medical treatment cases 1st aid treatment cases Damage to equipment or material Project standing time LTI (Lost Time injury) 	Likely to occur	Moderate	<ul style="list-style-type: none"> R/A training Correct tools to be used Only aluminium ladders Fall protection plan to be implemented SWP communicated All workers to have proof of medicals Direct supervision Correct manual handling 	<ul style="list-style-type: none"> No injury/ damage to workers or equipment 	Unlikely to occur	Low
4.11. Ironmongery <ul style="list-style-type: none"> Installation of hinges/bolts Installation of locks/doorstops 	<ul style="list-style-type: none"> Unsafe acts Wrong tools for task Incorrect use of hand/ electrical tools Hand & foot injuries due to unsafe work practices Unguarded grinding machinery Falling material Trip & fall hazards 	<ul style="list-style-type: none"> Medical treatment cases Damage to material leading to standing time LTI Medical treatment cases 1st aid treatment cases Slips/trips & fall leading to hand; foot; 	Likely to occur	Moderate	<ul style="list-style-type: none"> Direct supervision Induct/train workers on R/A SWP Communication Correct tools for the task Make use of correct PPE Implement FPP if required 	<ul style="list-style-type: none"> No injury/ damage to workers or equipment 	Unlikely to occur	Low

		back injuries			<ul style="list-style-type: none"> • Correct guarding • 1st aider to be present • 1st aid box • Emergency plan 			
4.12. Fitment of Balustrades (wooden) and installation of timber decking	<ul style="list-style-type: none"> • Inadequate offloading of balustrade material • Falling material & equipment • Trip & fall hazards • Wrong installation leading to work/job delays • Wrongful use of grinding, cutting machinery • Inadequate electrical extensions (unsafe wiring) • No machine guarding when grinding/cutting 	<ul style="list-style-type: none"> • Moderate to serious injuries • 1st aid treatment cases • Medical treatment cases • Cuts & bruises • LTI • Project standing time due to injuries 	Likely to occur	Moderate	<ul style="list-style-type: none"> • Direct supervision • Trained Artisans • Correct tools for task • Correct cutting discs and sufficient guarding • LOTO • Pre-checks on all electrical power tools • Train workers on R/A and SWP • Correct PPE to be worn 	<ul style="list-style-type: none"> • No injury/damage to workers or equipment 	Unlikely to occur	Low
4.13. Plastering - Internal - External - Screeds - Steel trowels & wooden floats	<ul style="list-style-type: none"> • Falling from unsafe temporary work platform • Unsafe W@H • Wrong work method could lead to injuries • Untrained personnel leading to poor work quality & work delays • Falling from ladder • Trip & fall hazards 	<ul style="list-style-type: none"> • Fall from height injuries: minor to serious injuries • 1st aid treatment cases • Medical treatment cases • LTI • Job standing time 	Likely to occur	High	<ul style="list-style-type: none"> • Direct supervision & management of the task • Correct tools for the job • Correct temporary work platforms to be used when plastering at heights • Correct PPE • SWP • R/A Training • Proper communication • Proof of medicals 	<ul style="list-style-type: none"> • No injury/damage to workers or equipment 	Unlikely to occur	Low
4.14. Plumbing activities & tiling of floors and walls	<ul style="list-style-type: none"> • Unqualified plumbers causing inadequate work practices and injuries to workers • Inadequate joining of pipes & fittings • Hand injuries • Poor housekeeping leading to trip & fall incidents • Unsafe work practices • Working in dark rooms 	<ul style="list-style-type: none"> • Moderate to serious hand/foot injuries • 1st aid treatment cases • Medical treatment cases • LTI • Project standing time (lost time) 	Likely to occur	Moderate	<ul style="list-style-type: none"> • Direct supervision • Correct manual handling procedures • Check SWL of loads (heavy equipment & material) • R/A training • SWP • Proper communication • Check for slippery 	<ul style="list-style-type: none"> • No injury/damage to workers or equipment 	Unlikely to occur	Low

	<ul style="list-style-type: none"> inadequate lighting Inadequate offloading of tiles (loads too heavy) No proper manual handling 				<ul style="list-style-type: none"> surfaces Medicals Correct PPE for task 			
4.15. Glazing - Installation of safety glass - Offloading & fitment - Installation of mirrors	<ul style="list-style-type: none"> Falling glass/windows when transporting & offloading at site Incorrect carrying Improper lifting could cause back injuries Cuts when glass material breaks Trip & fall hazards Working with sharp edges without correct PPE such as gloves 	<ul style="list-style-type: none"> Moderate to serious injuries Cuts due to falling glazing material Trip & fall injuries 1st aid treatment cases Medical treatment cases Damage to property & material if not correctly handled Project standing time (lost time) 	Likely to occur	High	<ul style="list-style-type: none"> Proper securing of load when transporting Ensure proper offloading SWP Training workers on R/A Proper equipment to cut glass material Direct supervision Correct PPE for the task Trained personnel 	<ul style="list-style-type: none"> No injury/damage to workers or equipment 	Unlikely to occur	Low
4.16. Construction of roof structures – all facilities	<ul style="list-style-type: none"> Workers not trained on W@H No proof of medicals for workers working at heights Structure not complying to SANS 10407-2015 edition 2 Poor quality control No legal requirements Incorrect PPE No proper supervision Time delays Homemade ladders – could lead to fall incidents Insufficient manual handling Unsafe handling when lifting heavy poles such as king post Fall incidents Hand injuries Unsafe installation of rafters Unsafe use of electrical tools Windy/rainy conditions Unsafe installation of ridge poles No fall arrest Unsafe ladder work 	<ul style="list-style-type: none"> Slip & fall from heights leading to: <ul style="list-style-type: none"> Serious injury even fatality Medical treatment cases 1st aid treatment cases Work stoppages due to poor workmanship 	Unlikely to occur	High	<ul style="list-style-type: none"> Training of workers W@H SWP Train workers in R/A Implement fall protection plan Appoint qualified scaffold erectors, inspectors and supervisors Ensure safe storage of material Direct supervision Pre-start checks on all electrical power tools Check guarding of grinding equipment Ensure only aluminium ladders used & properly inspected Ensure correct PPE for task Proper lifting & hoisting of poles: 	<ul style="list-style-type: none"> No injury/damage to workers, property or equipment 	Unlikely to occur	Low

	<ul style="list-style-type: none"> No sufficient scaffold structures No implementation of fall protection plan 				<ul style="list-style-type: none"> implement lifting & hoisting plan Emergency planning to be implemented Lifelines and fall arrest equipment to be used Ensure proper anchor points No work allowed in “drop zone” area 				
4.17. Landscaping	<ul style="list-style-type: none"> Slip trip & fall incidents Offloading of heavy material (big trees) Unsafe offloading of garden soil material Incorrect manual handling Unsafe use of wheelbarrow Unsafe handling of garden tools, excavations & planting of trees & shrubs Snakes; scorpions; spiders when moving rocks 	<ul style="list-style-type: none"> Damage to the environment Slip; trip & falls could cause minor – serious injuries 1st aid treatment cases Project stoppage time Snake bites – could have serious consequences 	Unlikely to occur	Moderate	<ul style="list-style-type: none"> Direct supervision Emergency plan in case of snake bite / scorpions/spiders Use of proper PPE (hand gloves) Protection from sun (hats) Adequate manual handling Train workers on SWP & R/A Correct/safe use of hand tools 	<ul style="list-style-type: none"> No injury/ damage to workers or equipment 	Unlikely to occur	Low	
5. GENERAL RISKS: (INCLUDING COVID-19, ERGONOMICS)									
1. Liquor; drugs; fire arms & dangerous weapons	<ul style="list-style-type: none"> Intoxication could cause “unsafe” acts Use of unauthorised weapons could cause serious injuries or fatalities 	<ul style="list-style-type: none"> Lost time injuries Fatalities Unsafe acts could cause serious injuries and endanger fellow workers Medical treatment cases 	Likely to occur	High	<ul style="list-style-type: none"> Strict access control by security Induct workers on use of drugs and alcohol on site Signing drug & alcohol policy Signage to be posted at all areas 	<ul style="list-style-type: none"> Informed employees No injury or harm No property damage No damage to equipment 	Unlikely to occur	Low	
2. Security	<ul style="list-style-type: none"> Insufficient security and access control could cause unsafe acts Unauthorised material smuggled out of premises Theft of equipment & material 	<ul style="list-style-type: none"> Project lost time due to equipment / material theft Smuggling of endangered animals Damage to environment Uncontrolled access Unauthorised 	Likely to occur	Moderate	<ul style="list-style-type: none"> Proper security control by registered security company Authority to search vehicles Signage at entrances to facilities 	<ul style="list-style-type: none"> Informed contractors; visitors No unauthorised entry Proper site security Proper access 	Unlikely to occur	Low	

		movement & potential property damage			<ul style="list-style-type: none"> Trained security personnel Entry/access/control exit system to be implemented 	control management		
6. SAFE GUARDING ADJACENT PROPERTIES / EXISTING SERVICES								
6.1 Safeguarding adjacent properties / existing services	<ul style="list-style-type: none"> Plans not made available to identify Damaging property by colliding with property, using plant Unsupported structures Not following existing plans provided. 	<ul style="list-style-type: none"> Material treatment cases Serious / fatality due to falling material Lost Time Injuries 1st Aid Treatment Cases 	Likely to happen	Moderate	<ul style="list-style-type: none"> Competent operator to be appointed Pre-start checks to be done. Ensure correct plans are available and executed Proper supervision. Correct PPE for task At least 5m from nearest power lines Toolbox talk 	<ul style="list-style-type: none"> No injury/damage to work force or equipment 	Unlikely to occur	Low
7. DUST CONTROL								
7.1 Dust control	<ul style="list-style-type: none"> Moving machinery causing dust Dust particles in eyes Dust in mouth Dust inhalation by public 	<ul style="list-style-type: none"> Inhalation of dust Eyes irritation due to dust LTI 1st Aid treatment 	Very likely to occur	Low	<ul style="list-style-type: none"> Dust suppression to be implemented. Use of vacuum cleaners 	<ul style="list-style-type: none"> No injury/damage to work force or equipment 	Unlikely to occur	Medium
8. ENVIRONMENTAL HAZARDS / WEATHER EXPOSURES								
8.1 Weather exposures – open roof trusses exposed to rain, wind, etc	<ul style="list-style-type: none"> Hazardous substances from the construction process entering rivers, streams or dams Waste substances from workshops, repair bays or salvage/scrap site Dust from construction work Gasses and fumes released into the atmosphere Roof openings when raining – rain into building Not covering roof in bad weather conditions. 	<ul style="list-style-type: none"> Damage to property if not properly covered Wind blowing covers Falling bricks 	Likely to occur	Low	<ul style="list-style-type: none"> Heavy duty tarpaulin to be supported over the width of opening and all to be properly secured. Not weighted down with bricks or tiles. Method statement from contractor to be provided Ensure no openings Inspect regularly Client communication 	<ul style="list-style-type: none"> No injury/damage to work force or equipment 	Unlikely to occur	Low
9. PROTECTION OF PUBLIC / EMPLOYERS STAFF								

9.1 Protection of public / employers staff when working on construction site	<ul style="list-style-type: none"> • Sub-standard time keeping and attendance records • Labour disputes can disrupt progress 	<ul style="list-style-type: none"> • Persons remaining on site after the official end of shift time could be injured • Legal disputes and strikes could lead to loss in production 	Likely to occur	Low	<ul style="list-style-type: none"> • Temporary covering areas. • Only work in designated areas handed over from client • Client communication 	<ul style="list-style-type: none"> • No injury/ damage to work force or equipment 	Unlikely to occur	Low	
10. COVID-19 COMPLIANCE									
10.1 Toolbox Talks Attendances	<ul style="list-style-type: none"> • Not keeping social distance (1m from each other) • Not being monitored or tested for the possibilities when showing symptoms for COVID-19 • No hand sanitizing equipment available • Employees staying in close contact with each other • Ignoring COVID-19 symptoms • Not seeking medical advice or attention • Not keeping the attendance group as small as possible to save time on toolbox talks. • Contractor not inducting workers on the COVID-19 safety programme • Allowing workers with a fever registering 38°C or higher • Allowing workers to continue after tested positive for COVID-19 • Not inducting workers on the basic hygiene programme 	<ul style="list-style-type: none"> • Personal Bodily harm • Fatality • Spreading of the COVID-19 disease. 	Very likely to occur	Extreme	<ul style="list-style-type: none"> • Keeping the group as small as possible • Keeping 1m social distance from each other • Regular monitoring of employees health by screening them using thermometer • Employees with symptoms of flu or cold are NOT allowed to work, they should be sent home for self-isolation. • Ensuring employees are issued with proper face masks and other related PPE • Ensure sufficient hand sanitation stations are erected for employees to wash hands. • Inducting workers on the COVID-19 disease safety programme • Inducting workers on basic hygiene programme. • Not touching eyes, 	<ul style="list-style-type: none"> • Informed vigilant law and safety abiding employees, and operators • No fatality • No injury • No bodily harm • Minimizing the spread of COVID-19 	Likely to occur	Moderate	

					mouth and nose. Regularly wash hands.			
10.2 Professional Progress Monthly / Bi-Weekly Meetings	<ul style="list-style-type: none"> • Not keeping social distance (1m from each other) • Not being monitored or tested for the possibilities when showing symptoms for COVID-19 • No hand sanitizing equipment available • No washing of hands regularly • Employees staying in close contact with each other • Ignoring COVID-19 symptoms • Not seeking medical advice or attention when showing possible symptoms for COVID-19. • Not wearing approved face masks to prevent the spread of COVID-19. • Allowing workers with a fever registering 38°C or higher • Allowing workers to continue after tested positive for COVID-19 • Not inducting workers on the basic hygiene programme 	<ul style="list-style-type: none"> • Personal Bodily harm • Fatality • Spreading of the COVID-19 disease. 	Very likely to occur	Extreme	<ul style="list-style-type: none"> • Keeping 1m social distance from each other • Regular monitoring of employees health by screening them using thermometer • Employees with symptoms of flu or cold are NOT allowed to work, they should be sent home for self-isolation. • Ensuring employees are issued with proper face masks and other related PPE • Ensure sufficient hand sanitation stations are erected for employees to wash hands. • Inducting workers on the COVID-19 disease safety programme • Inducting workers on basic hygiene programme. • Not touching eyes, mouth and nose. Regularly wash hands. 	<ul style="list-style-type: none"> • Informed vigilant law and safety abiding employees, and operators • No fatality • No injury • No bodily harm • Minimizing the spread of COVID-19 	Likely to occur	Moderate
10.3 Work Area	<ul style="list-style-type: none"> • Workers sharing work area whilst might be infected with COVID-19 • Not keeping social distance (1m from each other) • Not being monitored or 	<ul style="list-style-type: none"> • Personal Bodily harm • Fatality • Spreading of the COVID-19 disease. 	Very likely to occur	Extreme	<ul style="list-style-type: none"> • Keeping the workers group as small as possible • Keeping 1m social distance from each other 	<ul style="list-style-type: none"> • Informed vigilant law and safety abiding employees, and operators 	Likely to occur	Moderate

	<p>tested for the possibilities when showing symptoms for COVID-19</p> <ul style="list-style-type: none"> • No hand sanitizing equipment available • Employees staying in close contact with each other • Not wearing approved face masks to prevent the spread of COVID-19. • Allowing workers with a fever registering 38°C or higher • Allowing workers to continue after tested positive for COVID-19 • Not inducting workers on the basic hygiene programme 				<ul style="list-style-type: none"> • Regular monitoring of employees health by screening them using thermometer • Employees with symptoms of flu or cold are NOT allowed to work, they should be sent home for self-isolation. • Ensuring employees are issued with proper face masks and other related PPE • Ensure sufficient hand sanitation stations are erected for employees to wash hands. • Inducting workers on the COVID-19 disease safety programme • Inducting workers on basic hygiene programme. • Not touching eyes, mouth and nose. Regularly wash hands. 	<ul style="list-style-type: none"> • No fatality • No injury • No bodily harm • Minimizing the spread of COVID-19 		
10.4 Transportation Of Employees	<ul style="list-style-type: none"> • Overcrowding of transportation • Not keeping social distance (1m from each other) • Not being monitored or tested for the possibilities when showing symptoms for COVID-19 • No hand sanitizing equipment available • Employees staying in close contact with each other 	<ul style="list-style-type: none"> • Personal Bodily harm • Fatality • Spreading of the COVID-19 disease. 	Very likely to occur	Extreme	<ul style="list-style-type: none"> • Not transporting more than 50% of the allowed transport mass (example if it is a 22 seater, not more than 11 is allowed) • Keeping 1m social distance from each other • Regular monitoring of employees 	<ul style="list-style-type: none"> • Informed vigilant law and safety abiding employees, and operators • No fatality • No injury • No bodily harm • Minimizing the spread of 	Likely to occur	Moderate

	<ul style="list-style-type: none"> • Ignoring COVID-19 symptoms • Not seeking medical advice or attention • Not keeping the attendance group as small as possible to save time on toolbox talks. • Contractor not inducting workers on the COVID-19 safety programme • Sharing food and drinks • Allowing workers with a fever registering 38°C or higher • Allowing workers to be transported after tested positive for COVID-19 • Not inducting workers on the basic hygiene programme 				<ul style="list-style-type: none"> • health by screening them using thermometer • Employees with symptoms of flu or cold are NOT allowed to work, they should be sent home for self-isolation. • Ensuring employees are issued with proper face masks and other related PPE • Ensure sufficient hand sanitation stations are erected for employees to wash hands. • Inducting workers on the COVID-19 disease safety programme • Inducting workers on basic hygiene programme. • Not touching eyes, mouth and nose. Regularly wash hands. 	COVID-19		
10.5 Eating Area / Canteens	<ul style="list-style-type: none"> • Not keeping social distance (1m from each other) • Not being monitored or tested for the possibilities when showing symptoms for COVID-19 • No hand sanitizing equipment available • Employees staying in close contact with each other • Ignoring COVID-19 symptoms • Not seeking medical advice 	<ul style="list-style-type: none"> • Personal Bodily harm • Fatality • Spreading of the COVID-19 disease. 	Very likely to occur	Extreme	<ul style="list-style-type: none"> • Keeping 1m social distance from each other • Regular monitoring of employees health by screening them using thermometer • Employees with symptoms of flu or cold are NOT allowed to work, they should be sent 	<ul style="list-style-type: none"> • Informed vigilant law and safety abiding employees, and operators • No fatality • No injury • No bodily harm • Minimizing the spread of COVID-19 	Likely to occur	Moderate

	<ul style="list-style-type: none"> or attention • Not keeping the attendance group as small as possible to save time on toolbox talks. • Contractor not inducting workers on the COVID-19 safety programme • Sharing food and drinks • Allowing workers with a fever registering 38°C or higher • Allowing workers to continue after tested positive for COVID-19 • Not inducting workers on the basic hygiene programme 				<ul style="list-style-type: none"> home for self-isolation. • Ensuring employees are issued with proper face masks and other related PPE • Ensure sufficient hand sanitation stations are erected for employees to wash hands. • Inducting workers on the COVID-19 disease safety programme • Inducting workers on basic hygiene programme. • Not touching eyes, mouth and nose. Regularly wash hands. 			
10.6 Personal Hygiene In The Workplace	<ul style="list-style-type: none"> • Not keeping social distance (1m from each other) • Not being monitored or tested for the possibilities when showing symptoms for COVID-19 • No hand sanitizing equipment available • No washing of hands regularly • Employees staying in close contact with each other • Ignoring COVID-19 symptoms • Not seeking medical advice or attention when showing possible symptoms for COVID-19. • Not wearing approved face masks to prevent the spread of COVID-19. 	<ul style="list-style-type: none"> • Personal Bodily harm • Fatality • Spreading of the COVID-19 disease. 	Very likely to occur	Extreme	<ul style="list-style-type: none"> • Keeping 1m social distance from each other • Regular monitoring of employees health by screening them using thermometer • Employees with symptoms of flu or cold are NOT allowed to work, they should be sent home for self-isolation. • Ensuring employees are issued with proper face masks and other related PPE • Ensure sufficient hand sanitation 	<ul style="list-style-type: none"> • Informed vigilant law and safety abiding employees, and operators • No fatality • No injury • No bodily harm • Minimizing the spread of COVID-19 	Likely to occur	Moderate

	<ul style="list-style-type: none"> • Allowing workers with a fever registering 38°C or higher • Allowing workers to continue after tested positive for COVID-19 • Not inducting workers on the basic hygiene programme 				<ul style="list-style-type: none"> • stations are erected for employees to wash hands. • Inducting workers on the COVID-19 disease safety programme • Inducting workers on basic hygiene programme. • Not touching eyes, mouth and nose. Regularly wash hands. 			
10.7 Usage And Disposal Of Face Masks / Dust Masks	<ul style="list-style-type: none"> • Disposal incorrectly • Allowing other to use disposed / used masks • Disposing in general waste bins • Incorrect handling of the masks when disposing (allow people to handle used face masks) 	<ul style="list-style-type: none"> • Personal Bodily harm • Fatality • Spreading of the COVID-19 disease. 	Very likely to occur	Extreme	<ul style="list-style-type: none"> • Face masks to be disposed of as hazardous waste chemical. • Keeping 1m social distance from each other • Regular monitoring of employees health by screening them using thermometer • Employees with symptoms of flu or cold are NOT allowed to work, they should be sent home for self-isolation. • Ensuring employees are issued with proper face masks and other related PPE • Ensure sufficient hand sanitation stations are erected for employees to wash hands. • Inducting workers on the COVID-19 	<ul style="list-style-type: none"> • Informed vigilant law and safety abiding employees, and operators • No fatality • No injury • No bodily harm • Minimizing the spread of COVID-19 	Likely to occur	Moderate

					<p>disease safety programme</p> <ul style="list-style-type: none"> • Inducting workers on basic hygiene programme. • Not touching eyes, mouth and nose. Regularly wash hands. 			
10.8 Disease Control And Measuring	<ul style="list-style-type: none"> • Not keeping social distance (1m from each other) • Not being monitored or tested for the possibilities when showing symptoms for COVID-19 • No hand sanitizing equipment available • No washing of hands regularly • Employees staying in close contact with each other • Ignoring COVID-19 symptoms • Not seeking medical advice or attention when showing possible symptoms for COVID-19. • Not wearing approved face masks to prevent the spread of COVID-19. • Allowing workers with a fever registering 38°C or higher • Allowing workers to continue after tested positive for COVID-19 • Not inducting workers on the basic hygiene programme 	<ul style="list-style-type: none"> • Personal Bodily harm • Fatality • Spreading of the COVID-19 disease. 	Very likely to occur	Extreme	<ul style="list-style-type: none"> • Keeping 1m social distance from each other • Regular monitoring of employees health by screening them using thermometer • Employees with symptoms of flu or cold are NOT allowed to work, they should be sent home for self-isolation. • Ensuring employees are issued with proper face masks and other related PPE • Ensure sufficient hand sanitation stations are erected for employees to wash hands. • Inducting workers on the COVID-19 disease safety programme • Inducting workers on basic hygiene programme. • Not touching eyes, mouth and nose. Regularly wash hands. 	<ul style="list-style-type: none"> • Informed vigilant law and safety abiding employees, and operators • No fatality • No injury • No bodily harm • Minimizing the spread of COVID-19 	Likely to occur	Moderate

11. NIGHTWORKS

9.1 Night works – poor lighting work environment.	<ul style="list-style-type: none"> • Poor lighting • Unsafe working at heights – poor visibility • Worker fatigue • No emergency plan 	<ul style="list-style-type: none"> • Persons remaining on site after the official end of shift time could be injured • Moderate to serious injuries • Fall incidents • Medical treatment cases • 1st aid treatment cases • Damage to equipment or material • Project standing time • LTI 	Likely to occur	High	<ul style="list-style-type: none"> • Fatigue management plan to be provided • Night work application to client / engineer • Method statement for scope of works (no high risk works allowed) • Emergency plan to be amended. • Sufficient lighting 	<ul style="list-style-type: none"> • No injury/ damage to work force or equipment 	Unlikely to occur	Low
--	---	---	-----------------	-------------	---	--	-------------------	-----

List Requirements for the Job Site "Check <input checked="" type="checkbox"/>							
<input type="checkbox"/> Fall arrest equipment	<input type="checkbox"/> Steel capped boots	<input type="checkbox"/> Hard hat	<input type="checkbox"/> Safety glasses	<input type="checkbox"/> Hearing protection	<input type="checkbox"/> Gloves	<input type="checkbox"/> Reflective vest	
<input type="checkbox"/> Other equipment- Please List							
Training required							
List Mandatory Training Requirements for the Job Site / Job Activity "Check <input checked="" type="checkbox"/>							
<input type="checkbox"/> induction	<input type="checkbox"/> Site Induction	<input type="checkbox"/> Other Training, Please List:					
Permits required							
List Permits required for the Job Site prior to commencing work "Check <input checked="" type="checkbox"/>							
<input type="checkbox"/> Isolation & lockout permit	<input type="checkbox"/> Excavation permit	<input type="checkbox"/> Confined space permit	<input type="checkbox"/> Hot work permit	<input type="checkbox"/> Permit to work	<input type="checkbox"/> Other	Specify:	
Legislation / Standards / Codes							
Induction and sign off							
Project leader to induct all people performing this work <i>(By signing you hereby take the responsibility for maintaining the controls)</i>							
Project leader name:							
Induction register (attach additional pages if necessary)				Induction register (attach additional pages if necessary)			
No	Name	Signature	Date	No	Name	Signature	Date
1				6			
2				7			
3				8			
4				9			
5				10			

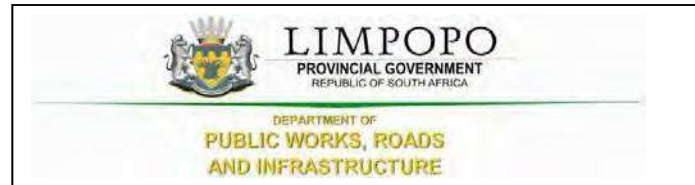

PART C7.2. 7: OHS SAFETY SPECIFICATIONS

CLIENT HEALTH AND SAFETY SPECIFICATIONS

AS PER OCCUPATIONAL HEALTH AND SAFETY ACT, NO. 85 OF 1993 AND CONSTRUCTION REGULATION, 2014



PROJECT: CONSTRUCTION OF NEW LIBRARY - INCLUDING ELECTRICAL, MECHANICAL INSTALLTION AND ASSOCIATED EXTERNAL WORKS AT VLEIFONTEIN – LDPWRI-B/20151



Date compiled: 10 OCTOBER 2021
Date reviewed: 12 OCTOBER 2021
Review nr: 002
Next Reviewal Date: OCTOBER 2023

COPYRIGHT: WORKSAFE: CONSTRUCTION OF NEW LIBRARY - INCLUDING ELECTRICAL, MECHANICAL INSTALLTION AND ASSOCIATED EXTERNAL WORKS AT VLEIFONTEIN

DOCUMENT CONTROL RECORD

Document prepared by:

Worksafe

Reg nr: 2002/052682/23
297 Marlothii Street
Broadlands Estate
Polokwane
0699

PO Box 12247
Bendor Park
Polokwane
0700
South Africa



Mr WJ van Rensburg
Health and Safety Consultant (Can CHSA – SACPCMP 087/2017)

T +27 15 296 4624/5
F +27 15 296 4614
E willie@worksafelim.co.za

CONTROL SHEET:

Declaration

This original document has been prepared, reviewed by the undersigned:

ORIGINAL		CLIENT
Prepared by: Worksafe	Reviewed by: CHSM	Commented on by: LDPW
Name: W J van Rensburg	Name: JP Spies	Name:
Signature: 	Signature: 	Signature:
Date: 12 OCTOBER 2021	Date: 12 OCTOBER 2021	Date: 12 OCTOBER 2021
Capacity: Health and Safety Agent: Worksafe	Capacity: Health and Safety Manager: Worksafe	Capacity: Client: 16.2 Appointee

PRINCIPAL CONTRACTOR RECEIPT

Received by: Construction Safety Manager:
Name:
Signature:
Date:
Capacity: 16.2 Appointee:

COPYRIGHT

All rights reserved. No part or section of this document may be changed, used, reproduced or distributed in any form or by any means, electronic, mechanical, photocopying or recording or otherwise, or stored in a data base or retrieval system, without the prior written permission of Worksafe.

FOREWORD:

These Coherent Health & Safety specifications for **CONSTRUCTION OF NEW LIBRARY - INCLUDING ELECTRICAL, MECHANICAL INSTALLTION AND ASSOCIATED EXTERNAL WORKS AT VLEIFONTEIN DISTRICT** has been compiled by using the Occupational Health & Safety Act. No 85 of 1993 and the Construction Regulations as amended on 7 Feb 2014. This document has been drawn up to assist the Principal Contractor and the Contractors to comply with the Act and the applicable Regulations.

Should there be any contradiction between this document and the Act, the Act must take preference except where explicitly stated. Similarly, where this document does not address a certain topic / task the act and applicable regulations must be used as the minimum requirement.

Should you be unclear about anything set out in this document, please contact this office. These specifications are site specific and include all works to be done by the principal contractor. The principal contractor will be responsible for all the work on site, as well as the maintenance portion.

Every endeavour has been made to address the most critical aspects relating to Health and Safety issues in order to assist contractors in adequately providing for Health and Safety of employees on site. However, the Principal Contractor and is required to ensure they stay compliant with statutory requirements and construction programs and processes and include such aspects in their Health and Safety file.

These Health and Safety Specification was prepared by WJ Jansen van Rensburg registered at the South African Council for the Project and Construction Management Professions (SACPCMP) as a Construction Health and Safety Manager (CHSM 915/2019) and Candidate Construction Health and Safety Agent (Can CHSA 087/2017).

No part of this document may be reproduced, transmitted, transcribed, and stored in a retrieval system in any form or by any means without written permission. Any unauthorised reproduction of this work will constitute a copyright infringement and render the perpetrator liable under both civil and criminal law.

Communication channel

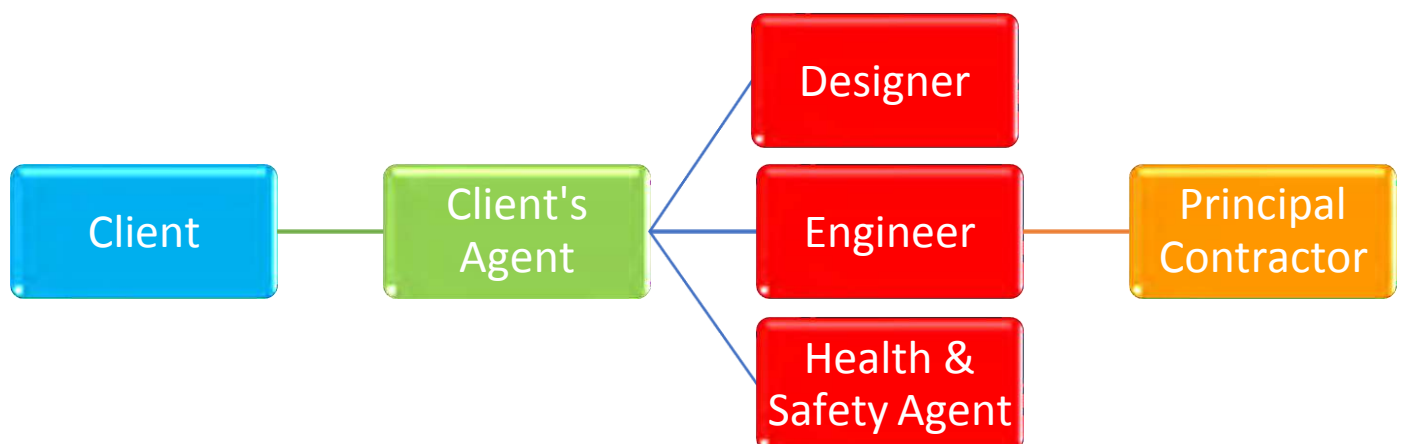

Table of Contents

1. INTRODUCTION	1
1. BACKGROUND TO THE COHERENT HEALTH & SAFETY SPECIFICATIONS	1
2. RESPONSIBILITY & ACCOUNTABILITY	1
3. PURPOSE OF THE HEALTH AND SAFETY SPECIFICATIONS.....	1
4. IMPLEMENTATION OF THE HEALTH AND SAFETY SPECIFICATIONS.....	1
5. ABBREVIATIONS	2
2. OCCUPATIONAL HEALTH & SAFETY MANAGEMENT.....	3
1. ROLES	3
2. IMPLEMENTATION OF THE HEALTH AND SAFETY SPECIFICATIONS (DRAFTING OF THE COHERENT HEALTH & SAFETY PLAN).....	6
3. OCCUPATIONAL HEALTH & SAFETY MANAGEMENT	6
1. SCOPE OF THE PROJECT.....	6
2. THE EXTENT OF THE WORKS.....	7
3. INTERPRETATIONS.....	10
<i>Application</i>	10
<i>Definitions</i>	10
4. MINIMUM ADMINISTRATIVE REQUIREMENTS.....	11
<i>Notification of Construction work</i>	11
<i>Principal Contractor (CR 5)</i>	11
<i>Pin-up Board in site office</i>	13
5. PRINCIPAL CONTRACTORS, CONTRACTORS AND SUB-CONTRACTORS	15
<i>Principal Contractor's and Contractors' Requirements</i>	15
<i>Principal Contractor / Contractor Competency Assessment</i>	16
<i>Pricing for Occupational Health & Safety Compliance</i>	16
<i>Contractors' Coherent Health & Safety Plans [Construction Regulations 7]</i>	17
<i>Communication and Management of the work</i>	17
6. CLIENT IDENTIFIED HAZARDS AND POTENTIALLY HAZARDOUS SITUATIONS.....	17
<i>OHS Agent High Risks identified (Baseline R/A provided as separate document)</i>	17
<i>Unforeseeable Hazards</i>	18
7. SITE OPERATIONAL REQUIREMENTS.....	18
7.1. <i>Health and Safety Representative</i>	18
7.2. <i>Health and safety committees</i>	18
7.3. <i>Health and safety training</i>	18
7.4. <i>Health & Safety audits, monitoring and reporting</i>	19
7.5. <i>Emergency procedures</i>	19
7.6. <i>Medical certificate of fitness</i>	20
7.7. <i>First aid boxes and first aid equipment</i>	20
7.8. <i>Personal protective equipment (PPE) and Clothing (PPC)</i>	20
7.9. <i>Occupational Health and Safety signage's</i>	21
7.10. <i>Site hording & Access control (Site camp area)</i>	21
7.11. <i>Night Work (After Hours)</i>	21
7.12. <i>Transport of workers</i>	22
7.13. <i>Fatigue management</i>	22
7.14. <i>Illumination</i>	22
8. PHYSICAL SITE SAFETY REQUIREMENTS	22
8.1. <i>Site establishment</i>	22
8.2. <i>Blasting – NOT REQUIRED AS PER SCOPE</i>	23
8.3. <i>Borrow pits</i>	28
8.4. <i>Principal Contractor Construction board</i>	28

8.5.	<i>Existing structures CR 11</i>	29
8.6.	<i>Underground and internal services</i>	29
8.7.	<i>Demolition CR 14</i>	29
8.8.	<i>Earthworks (Civil works) CR 13</i>	30
8.9.	<i>Excavations CR13</i>	31
8.10.	<i>Heritage and Archaeological sites</i>	32
8.11.	<i>Graves & Middens</i>	32
8.12.	<i>Ladders GSR 13</i>	32
8.13.	<i>Scaffolding CR 16</i>	33
8.14.	<i>Trestles SANS 10085</i>	34
8.15.	<i>Fall protection - Fall Risk positions CR 10</i>	35
8.16.	<i>Edge protection, Barricading and Penetrations</i>	38
8.17.	<i>Roof work CR 10</i>	38
8.18.	<i>Temporary works CR 12</i>	39
8.19.	<i>Motorized Platforms (Streetlight installations)</i>	40
8.20.	<i>Traffic and pedestrian accommodation</i>	40
8.21.	<i>Confined Spaces</i>	41
8.22.	<i>Deliveries, Waste removal, Stacking/Storage of materials</i>	41
8.23.	<i>Fire extinguishers and fire fighting equipment</i>	42
8.24.	<i>Designated smoking area</i>	43
8.25.	<i>Thunder & Lighting</i>	43
9.	PLANT, EQUIPMENT AND MACHINERY	43
9.1.	<i>Construction Vehicles & Mobile plant CR 23</i>	43
9.2.	<i>Hired plant and machinery</i>	43
9.3.	<i>Cranes and lifting equipment</i>	44
9.4.	<i>Explosive actuated fastening devices</i>	45
9.5.	<i>Electrical Installation and portable electrical Tools</i>	45
9.6.	<i>General Machinery</i>	47
10.	OCCUPATIONAL HEALTH	47
10.1.	<i>Industrial Hygiene</i>	47
10.2.	<i>Hazardous Chemical Substance (HCS)</i>	47
10.3.	<i>Alcohol and other drugs</i>	48
10.4.	<i>Medical certificate of fitness</i>	48
10.5.	<i>Welfare Facilities</i>	48
10.6.	<i>Ergonomics</i>	49
10.7.	<i>Snakes and Snakebites</i>	49
11.	<i>COVID 19:</i>	49
	ANNEXURE A	61
	ANNEXURE B	62
	ANNEXURE C	65
	ANNEXURE D	67
	ANNEXURE E	70
	ANNEXURE F	72

1. INTRODUCTION

1. **Background to the Coherent Health & Safety Specifications**

The Construction regulations (7 Feb 2014) places the Onus on the CLIENT to prepare a Coherent Health & Safety Specification, highlighting risks not successfully eliminated during design. The client (LIMPOPO DEPARTMENT OF PUBLIC WORKS: ROADS AND INFRASTRUCTURE) also has the opportunity to set the tone and standard of Occupational Health & Safety on the construction site.

2. **Responsibility & Accountability**

It is imperative to understand the process of determining legal accountability, as the OHS-Act is the only criminal Act still administered by the Department of Labour. It *assumes* that the CEO is overall accountable even though he may delegate some of his responsibilities. This principal is entrenched in Section 37(1) of the Act. This is generally referred to as the REASONABLE MAN TEST. SECTION 37: Acts or omissions by employees or Mandatories

3. **Purpose of the Health and Safety Specifications**

The purpose of this specification document is to provide the relevant Principal Contractor) and contractor with any information other than the standard conditions pertaining to construction sites which might affect the health and safety of persons at work and of persons in connection with the use of plant and machinery during Construction work phase Civil & Electrical; roads; storm water and road works.

4. **Implementation of the Health and Safety Specifications**

To brief the Principal Contractor on the significant health and safety requirements and aspects of the project. This shall include the provision of the following information and requirements namely:

- a) *Safety considerations affecting the site of the project and its environment.*
- b) *Health and safety aspects of the associated structures and equipment.*
- c) *Required submissions on health and safety matters from the Principal Contractor (or contractors appointed under P.C).*
- d) *The Principal Contractor's (Sub - Contractors) health and safety plan.*

To that the Principal Contractor (Contractors) is fully aware of what is expected from them with regards to the Occupational Health and Safety Act, 85 of 1993 and the Regulations made there-under including the applicable safety standards, and in particular in terms of Section 8 and 44 of the Act.

To inform the Principal Contractor that the Occupational Health and Safety Act, 85 of 1993 in its entirety shall apply to the contract to which this specification document applies. The Construction Regulations promulgated on 7 February 2014 and incorporated into the above Act by Government Notice R 84, published in Government Gazette 37305 shall specifically apply to all persons involved in the construction work pertaining to this project.

“Purpose of the Act” –To provide for the health and safety of persons at work and the health and safety of persons in connection with the use of plant and machinery; the protection of persons other than persons at work against hazards to health and safety arising out of or in connection with the activities of persons at work; to establish an advisory council for occupational health and safety; and to provide for matters connected therewith.

“Agent” –means a competent person who acts as a representative for a client.

“Client” –means any person for whom construction work is performed; **“Construction manager”** means a competent person responsible for the management of the physical construction processes and the coordination, administration and management of resources on a construction site.

“Construction site” means a workplace where construction work is being performed.

"Construction supervisor" means a competent person responsible for supervising construction activities on a construction site.

"Construction work" means any work in connection with –

- a) The construction, erection, alteration, renovation, repair, demolition or dismantling of or addition to a building or any similar structure;
- b) The construction, erection, maintenance, demolition or dismantling of any bridge, dam, canal, road, railway, runway, sewer or water reticulation system; or the moving of earth, clearing of land, the making of excavation, piling, or any similar civil engineering structure or type of work.

"Contractor" means an employer who performs construction work.

"Designer" means-

- a) A competent person who-
Prepares a design.
Checks and approves a design.
Arranges for a person at work under his or her control to prepare a design, including an employee of that person where he or she is the employer; or
Designs temporary work, including its components.
- b) An architect or engineer contributing to or having overall responsibility for a design.
- c) A building services engineer designing details for fixed plant.
- d) A surveyor specifying articles or drawing up specifications.
- e) A contractor carrying out design work as part of a design and building project; or an interior designer, shop-fitter or landscape architect.

"Health and Safety File" –means a file, or other record containing the information by the Construction Regulations.

"Health and Safety Plan" –means a site, activity or project specific documented plan in accordance with Health and Safety Specification.

"Health and Safety Specification" –means a site, activity or project specific document prepared by LIMPOPO DEPARTMENT OF PUBLIC WORKS: ROADS AND INFRASTRUCTURE pertaining to all Health and Safety Requirements related to the construction work as per design.

"Method Statement" –means a document detailing the key activities to be performed in order to reduce as reasonably as practicable the hazards identified in any risk assessment.

"Principal contractor" means an employer appointed by LIMPOPO DEPARTMENT OF PUBLIC WORKS: ROADS AND INFRASTRUCTURE to perform construction work at the CONSTRUCTION OF NEW LIBRARY - INCLUDING ELECTRICAL, MECHANICAL INSTALLATION AND ASSOCIATED EXTERNAL WORKS AT VLEIFONTEIN DISTRICT.

"Risk Assessment" –means a program to determine any risk associated with any hazard at a construction site, in order to identify the steps needed to be taken to remove, reduce or control such hazard.

5. **Abbreviations**

GMR:	General Machinery Regulations
OHS Act:	Occupational Health & Safety Act. Act 85 of 1993
Constr Reg:	Construction Regulation 2014
ORHVS:	Operating Regulations for High Voltage Systems
PPE:	Personal Protective Equipment
GAR:	General Administrative regulations
DMA:	Disaster Management Act 2002: Alert Level 2

QS:	Quantity Surveyor
GSR:	General Safety regulations
EXP Reg:	Explosive Regulation
ERW:	Environmental regulations for workplaces
FR:	Facilities Regulations
HCS:	Hazardous Chemical Substance Regulations
NIHLR:	Noise Induced Hearing Loss Regulation
DMR:	Driven Machinery Regulation
EIR:	Electrical Installations Regulation
EMR:	Electrical Machinery Regulation
RN:	Road Note 13
NT:	National Road Traffic Act
AR:	Asbestos Regulation
NEMA:	National Environmental Management Act
SANS:	South Africa National Standards
MSDS:	Material Safety Data Sheets

2. OCCUPATIONAL HEALTH & SAFETY MANAGEMENT

1. Roles

1.1. Client/ Agent:

- a) Prepare a Baseline Risk Assessment and issue a health and safety specification to the Principal Contractor, Designer and include the specification in tender documentation.
- b) LIMPOPO DEPARTMENT OF PUBLIC WORKS: ROADS AND INFRASTRUCTURE or the appointed Client's Agent will appoint each Principal Contractor for this project or phase/section of the project in writing for assuming the role of Principal Contractor as intended by the Construction Regulations.
- c) LIMPOPO DEPARTMENT OF PUBLIC WORKS: ROADS AND INFRASTRUCTURE or the appointed Client's Agent shall discuss, negotiate and approve the contents of the specified project health and safety plan submitted by the Principal and Sub Contractor.
- d) LIMPOPO DEPARTMENT OF PUBLIC WORKS: ROADS AND INFRASTRUCTURE or his Agent will take reasonable steps to ensure that the health and safety plan of the Principle and Sub Contractor is correctly implemented and maintained. Monthly audits shall be conducted to monitor the compliance. (Construction Phase)
- e) In the event of design changes LIMPOPO DEPARTMENT OF PUBLIC WORKS: ROADS AND INFRASTRUCTURE or the appointed Agent on his behalf will ensure that enough resources will be provided to implement the work safely.
- f) LIMPOPO DEPARTMENT OF PUBLIC WORKS: ROADS AND INFRASTRUCTURE or his appointed Agent on his behalf will prevent the Principal Contractor and/or the Contractor from commencing or continuing with construction work should the Principal Contractor and/or the Contractor at any stage in the execution of the works be found to:

Have failed to have complied with any of the administrative measures required by the Construction Regulations in preparation for the construction project or any physical preparations necessary in terms of the Act.

Have failed to implement or maintain their health and safety plan.

Have executed construction work which is not in accordance with their health and safety plan.

Have acted in any way which may pose a threat to the health and safety of any person(s) present on the site of the works or in its vicinity, irrespective of him/them being employed or legitimately on the site of the works or in its vicinity.

1.2. Designer

- Must take into account the Health and Safety Specifications of LIMPOPO DEPARTMENT OF PUBLIC WORKS: ROADS AND INFRASTRUCTURE.
- Before the tender process, the designer must make available a report to LIMPOPO DEPARTMENT OF PUBLIC WORKS: ROADS AND INFRASTRUCTURE about :
 - All the relevant health and safety information about the design of the relevant structure that might affect the pricing of the construction work.
 - The geotechnical –science aspects, where appropriate.
 - The loading that the structure is designed to withstand.
- Inform LIMPOPO DEPARTMENT OF PUBLIC WORKS: ROADS AND INFRASTRUCTURE in writing of any known or anticipated dangers or hazards related to the project.
- Make available all relevant information required for the safe execution of the work upon being designed or when the design is subsequently altered.
- During the design take into account the hazards relating to any subsequent maintenance to be performed with the minimum risk.
- During the design stage cognizance of ergonomic design principals must be applied in order to minimize ergonomic related hazards in all phases of the life cycle of a structure.

1.3. Employers Agent

The Employers Agent shall ensure that the contractor has made sufficient provision for all Health & Safety costs. The Employers Agent shall ensure that the contractor had in a bill of quantities for Health & Safety. The Employers Agent takes full responsibility if contractor does not have sufficient budget to cater for all Health & Safety needs.

1.4. Construction Health & Safety Officer Duties

A full-time construction health and safety Officer (in terms of Construction Regulation 8) will be required on this project. **The Construction Health and Safety Officer must be registered with SACPCMP on at least a Construction Health and Safety Officer level and proof of the appointee letter of good standing is compulsory before any work can commence.**

The Construction Health & Safety Officer will be required to carry out at least the following duties:

Before commencement and during the construction phase of the project you shall:

- Assist with the preparation of a construction health and safety plan
- Confirm necessary documentation was submitted to the relevant authorities
- Attend project planning meetings
- Assist with the assessments and approval of subcontractor(s) health and safety plans
- Attend the site handover
- Attend regular site, technical and progress meetings
- Facilitate health and safety site meetings
- Participate in the identification of the hazards and risks relevant to the construction project through regular coordinated site inspections
- Establish and maintain health and safety communication structures and systems, distribution of health and safety specific documents to sub-contractors
- Compiling project specific emergency response and preparedness plans

- Testing the effectiveness of the emergency response plans
- Conduct site safety inductions to own personnel & visitors
- Monitor, measure and report on health and safety system performance by performing monthly health and safety audits (internal)
- Evaluate the levels of compliance of subcontractors to the project specific health and safety plan and client specifications
- Oversee the reporting and investigation of project related incidents
- Manage reporting of non-compliance issues and take appropriate corrective and preventative action
- Oversee the maintenance and safe keeping of all records
- Incorporation of changes into a health and safety management system
- Review and update the health and safety plan

At the close out of the project, you shall:

- Review, discuss and approve the health and safety file with the contractor(s) and manage site health and safety during the defects liability period
- Prepare the consolidated project health and safety file for the client

In addition to the above, it is also your duty to:

- Enforce such measure as may be necessary in the interest of health and safety;
- That all employees are informed regarding the scope of their authority as contemplated in Section 37.1.b of the Act;
- That all necessary measures are taken to ensure that the requirements of the Act and its regulations are complied with by every person employed at Principal Contractor
- Ensure that the required training and knowledge is provided regarding the terms of the Act and regulations.
- Provide all employees and contractors with access to the Occupational Health and Safety Act as well as the organization's SHEQ program documentation and information as is necessary and where required.
- You are charged with reporting on the following issues, trends and other relevant information to the Clients Health & Safety Agent.
- Deviations and areas of non-compliance (which you cannot rectify) – Immediately.
- Submitting a monthly OHS Progress report including LTI (exposure hours).

The monthly report shall consist of the following information and shall be submitted in the approved format of trends, graphs, completion and databases (template provided by the Client Safety Agent):

- Site Inspections.
- Internal Inspections/Audits.
- Planned Task Observations.
- Task Analysis.
- Continuous Risk Assessments.
- Performance Measurement of Employees.
- Incidents (Near misses, Accidents, Illnesses, First Aid Treatments)
- Investigations
- Tool box talks
- Medicals (New employees, Scheduled medicals)
- Competency information (Drivers, First Aiders, Fire Fighters, HS Representatives etc)
- Training required

1.5. Construction Manager Duties: CR8.1

In terms of this appointment, you are personally accountable and responsible for the overall management of the site.

In addition thereto, you are also responsible for ensuring compliance with the requirements in terms of Health and Safety on this site.

To this end, you are to ensure that the following documented procedures are adhered to at all times:

- Implementing Clients Baseline Risk Assessment
- The Health & Safety Specification for the project,
- The Approved Health & Safety Plan for the project issued by the Client Safety Agent
- The Approved Health & Safety Plan of each contractor appointed for the project.

You are required to appoint an Assistant Construction Manager to assist you in performing your duties, but under no circumstances may you manage any other projects other than the one to which this appointment refers.

You are required to appoint Construction Supervisors for various sections of the Site to assist in the implementation and enforcement of the Health & Safety procedures detailed in the Health & Safety Plans.

You are required to report to me on the following issues every month:

Examples:

- Health and Safety Representative Inspections.
- Internal Inspections/Audits.
- Planned Task Observations.
- Task Analysis.
- Continuous Risk Assessments.
- Performance Measurement of Employees.
- Incidents (Near misses, Accidents, Illnesses, First Aid Treatments)
- Incident Investigations
- Medicals (New employees, Scheduled medicals)
- Competency information (Operators, Drivers, First Aiders, Fire Fighters, HS Representatives etc.)

2. Implementation of the Health and Safety Specifications (Drafting of the Coherent Health & Safety Plan)

These Health & Safety specifications document forms an integral part of the contract, and the Principal Contractor is expected to use it when compiling its project-specific Coherent Health & Safety plan. The Principal Contractor must forward a copy of these specifications to all Contractors at their bidding stage so that they can in turn prepare coherent Health & Safety plans relating to their operations. This Specification can be revised during the construction process as new risk and hazards arises or in the case of a scope change

3. Occupational Health & Safety Management

1. Scope of the project

These Specifications set out the requirements for eliminating or if this is not possible, for minimising as far as reasonably practicable, the risk of incidents and injuries occurring at Client. This document covers work to be undertaken of the project and sets out the rules and procedures for engagement on the project. The scope also addresses legal compliance, Client standards, hazard identification and risk assessment, risk

control, and the promotion of a health and safety culture amongst those working on the project. The Health & Safety specifications also make provision for the protection of those persons other than employees.

The 6 Stages of Construction (SACPCMP)

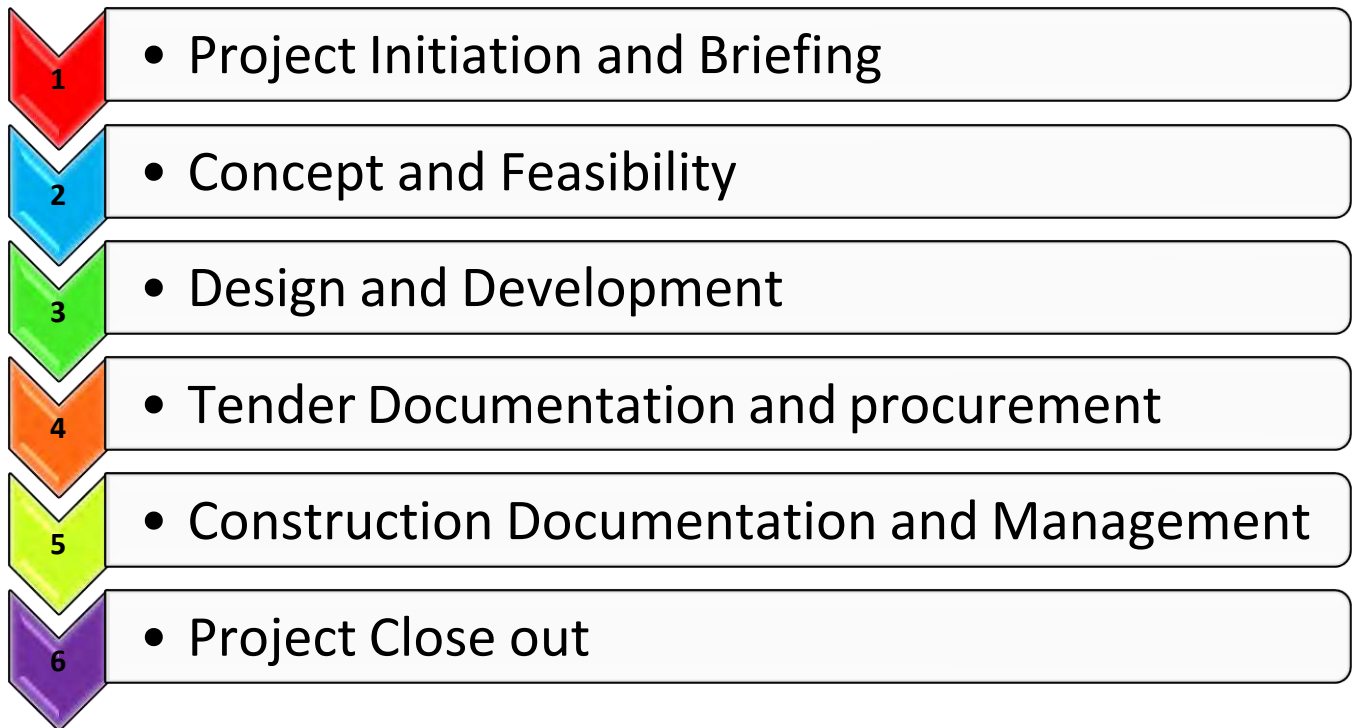

2. The extent of the works

These specifications are applicable to the specific scope of work pertaining to the CONSTRUCTION OF NEW LIBRARY – INCLUDING ELECTRICAL, MECHANICAL INSTALLATION AND ASSOCIATED EXTERNAL WORKS AT BOTSHABELO, IN THE WATERBERG DISTRICT as detailed in the tender documents including the following:

The CONSTRUCTION OF NEW LIBRARY – INCLUDING ELECTRICAL, MECHANICAL INSTALLATION AND ASSOCIATED EXTERNAL WORKS AT VLEIFONTEIN DISTRICT will cover the following main items:

- EARTHWORKS
 - Site clearance
 - Filling (general)
 - CBR and indicator tests to be done
 - Density tests to be done
 - Carting away of excessive and/or unsuitable excavated materials
 - Layer works
 - Sand bed spread over layer works
 - Stabilization of compacted layers
 - Compaction of surfaces
- EXCAVATION WORKS
 - Excavate Trenches (Including for electrical and plumbing services)
 - Backfill excavations
 - Preparation of sand bed
 - Compaction of soil
- SOIL POISONING
 - To bottom and sides of trenches, holes, etc

- Under floors, etc including forming and poisoning shallow furrows against foundation walls, etc
- Under paving, aprons, etc
- CONCRETE, FORMWORK AND REINFORCEMENT
 - Concrete test cubes
 - Formwork
 - Preparation of steel fixing.
 - Mass concrete casting (column bases, surface beds, ramps, ground beams)
 - Casting of beams and inverted beams
 - Casting of columns
 - Casting of stub columns
- SUNDRIES
 - Finishing surfaces of concrete smooth with a wood float(surface beds, slabs, aprons, ramps, etc)
- STRUCTURAL STEEL WORKS
 - Installation of mild steel columns and beams
 - Installation of mild steel bolted purlins, girts, bracing, etc
 - Installation of steel trusses (hoisting into position).
 - Painting of steel structure.
- MOVEMENT JOINTS
 - Movement joints
 - Expansion joints
- MASONRY (BRICKWORK + FACE BRICK)
 - Installation of wall ties
 - Sub-structure brick work (foundation)
 - Installation of brick reinforcement in foundation
 - Superstructure brick work including brick reinforcement, turning pieces, movement joints (half brick walls, half brick walls in beam filling, half brick walls in fire wall, yard brick walls.)
- PLASTERING WORKS
- WATERPROOFING
 - Damp proofing of walls and floors
- JOINT SEALANTS
 - Silicone sealing between timber fittings and plastered walls
 - Silicone sealing between sanitary fittings and wall ties
 - Sealing in expansion joints
- ROOF COVERINGS
 - Installation of roof purlins, trusses, etc
 - Installation of prefabricated roof trusses
 - Insulation installation
 - Installation of sheet metal flashing, linings, copings, etc.
 - Installation of galvanised steel sheeting
 - Installation of eaves, verges, etc
- INSTALLATION OF ALUMINIUM WINDOWS, ETC
- INSTALLATION OF TIMBER SKIRTINGS
- INSTALLATION OF DOORS
- CEILINGS, PARTITIONS AND ACCESS FLOORING
 - Installation of ceilings
 - Installation of suspended ceilings, bulkheads, etc.
 - Installation of Bates access flooring
- INSTALLATION OF IRONMONGERY
 - Installation of hinges

- Installation of handles push plates and kicking plates
- Installation of door closers and floor springs
- Installation of Kimberly Clark hand soap dispenser
- Installation of grab rails
- Installation of steel lockers
- Installation of pinning boards, writing board, projection screens, etc
- Installation of signage
- METAL WORK
 - Installation of burglar bars to windows
 - Installation of glazing beads to windows
 - Installation of gates to external doors
- INSTALLATION OF ROLLER SHUTTER DOORS
- EPOXY OF FLOORS
- INSTALLATION OF WALL TILES
- INSTALLATION OF FLOOR TILES
- INSTALLATION OF PLUMBING AND DRAINAGE
 - Installation of uPVC pipes and fittings
 - Installation of copper pipes
 - Installation of flush pans
 - Installation of soil drainage
 - Installation of sanitary plumbing (uPVC pipes + fittings)
 - Fitting of sanitary (taps, hand basins, toilets, etc)
- INSTALLATION OF FIRE HOSE REELS AND 9kg DRY CHEMICAL FIRE EXTINGUISHER
- INSTALLATION OF TOPS, SHELVES, DOORS, MIRRORS, ETC
- GENERAL PAINTWORK
- GENERAL LANDSCAPING WORKS
- INSTALLATION OF CONCRETE BLOCK PAVING (ROADS)
- INSTALLATION OF ROADS SIGNS AND MARKINGS
- INSTALLATION OF FENCING
- INSTALLATION OF MAIN SEWER LINE
 - Excavation of trench
 - Bedding
 - Laying of sewer line
 - Backfilling
 - Compaction and testing
- SEWER TREATMENT WORKS
 - Construct a septic tank 2460 x 7310 x 2600mm high with soak away
 - Constructed with 25mpa bottom and top slab
- WATER AND FIRE RETICULATION
 - Excavation of trench
 - Bedding
 - Laying of lines
 - Backfilling
 - Compaction and testing
 - Installation of special fittings (fire hydrant bend: cast iron fire hydrant)
 - Construct of a valve chamber
 - Hydraulic pipe testing
- INSTALLATION OF ELEVATED AND GROUND TANKS
- INSTALLATION OF BOREHOLE
- MV RETICULATION - SUPPLY AND INSTALL 50kVA 11kV/400 TRANSFORMER COMPLETE WITH STRUCTURES AND POLES.

- LV RETICULATION
 - Installation of new Distribution Kiosk
 - Installation of plinth
 - Trenching
 - Laying of sleeves and cables (including cable warning tape, cable marker and labels)
 - Installation of cable terminations
 - Installation of earth conducted
 - testing
- MAIN LIBRARY BUILDING (ELECTRICAL WORKS)
 - Draw wires
 - Installation of distribution boards
 - Build or chase into brick or concrete work
 - Installation of PVC wiring in conduits
 - Installation of copper earth wire
 - Installation of switches
 - Installation of socket outlets
 - Installation of light fittings
 - Installation of area lighting
- ELECTRONIC INSTALLATION (CCTV AND NETWORK DATA SYSTEMS)
- HVAC INSTALLATIONS
 - General HVAC installation
 - Duct work
 - Installation of air diffusor
 - Fans
 - Installation of sound attenuators
 - Installation of fan coil units, fan air terminals and fan heaters
 - Piping
 - Installation of ablution HVAC system
- FIRE DETECTION, SUPPRESION AND PROTECTION
 - Installation of fire detection system
 - Installation of fire protection system
- WATER SERVICES
 - Installation of water supply piping
 - Installation of grey water drainage piping
 - Installation of water heating system
 - Installation of water purification system

Demarcated area will be provided to the contractor to erect site camp facilities. No workers/personnel will be allowed to sleep-over on site. The site camp need to be fenced off with fencing material covered with shade net material.

3. **Interpretations**

Application

This specification is compiled with reference of South African legal requirements. and the client's specifications. The PC is reminded that if any additional guidelines are required, the construction manager has to contact the client or representative directly to prepare and issue updated guidelines. The definitions as listed in the Occupational Health & Safety Act 85/1993 and Construction Regulations (February 2014) apply throughout this document.

Definitions

The definitions as listed in the OHS Act 85/1993 and Construction Regulations (2014)

- CHSA = Construction Health & Safety Agent
- Contractor includes a Principal Contractor / Direct / Sub-contractors.
- Contractor's Construction Manager as defined in the Construction Regulations 2014 [CR 8(1)] as the Construction Manager. This is not the Client's Project Construction Manager / site representative.
- Directs – Any Contractor appointed directly by the construction Client.
- Principal Agent = P/Agent = Client Representative.
- Principal Contractor will include any Contractor appointed directly by the Client on the project.
- Where the term Principal Contractors (plural) is used this refers to all Directs appointed on the project, which Directs are all Principal Contractors in their own right.

4. **Minimum Administrative Requirements**

Notification of Construction work

The project entails construction work activities less than 12 months and therefore the contractor need to submit a Notification of Construction (Reg 4) to DoEL.

4. Notification of Construction Work:

- (1) *A contractor who intends to carry out any construction work other than work contemplated in regulation 3(1), must at least 7 days before that work is to be carried out notify the provincial director in writing in a form similar to Annexure 2 if the intended construction work will-*
 - (a) *include excavation work;*
 - (b) *include working at a height where there is risk of falling;*
 - (c) *include the demolition of a structure; or*
 - (d) *include the use of explosives to perform construction work.*
- (2) *A contractor who intends to carry out construction work that involves construction of a single storey dwelling for a client who is going to reside in such dwelling upon completion, must at least 7 days before that work is to be carried out notify the provincial director in writing in a form similar to Annexure 2*

Principal Contractor (CR 5)

The client selected and direct appointed contractors who will work directly under supervision of the appointed Principal Contractor. The PC will issue the specification or applicable section thereof to the contractor. The client appointed **Principal Contractor** with the responsibility to carry out and supervise the required construction, own selected and client direct appointed contractor's. The client and designers issued the principal contractor (PC) with the following documents:

- CR 5 Appointment
- Mandatory agreement (37.2) (between client and appointed contractor)
- Project Baseline Risk Assessment
- Project site specification
- Project design and drawings
- COVID-19 Protocol requirements

The PC shall comply with the client's specification and appoint a fulltime qualified, registered SACPCMP safety officer for the project to support the project construction manager, managing project safety further:

The safety officer/manager will be responsible to carryout general safety officer's duties, specifically

- Audit contractors SHE plan and project safety file 7 days before the start of the contract or correspond with returnable & contract document.
- Record all appointed contractors audit scores on a register.

- Forward the reports required by this specification to the project safety agent on the 25th of the month on a monthly basis.
- To keep an updated project risk register (PC and contractor task risk assessments)
- The PC will ensure that project H&S file and all contractor files will consist of the following (see Annexure D file index sample):
- Updated index or content register
- Client mandatory agreement and CR5 appointment
- A company project HS&E policy
- A company project HS&E plan which shall display be written using the Coherent Health & Safety specification as standard
- A detailed organogram that display all the appointments that will be made for the project that includes contractors that will be appointed within the specific scope of work.
- All appointments accompanied by the members ID, competencies and medicals
- The risk assessment methodology, method statements or procedures and risk assessments for all tasks and activities.
- Specific tasks required detailed operational plans or method statements, This will be supported by task and PPE assessments.
- The PC's incident and accident plan and methodology of reporting incidents with supported registers and documentation e.g. Incident report, Annexure 1, WCL2 and incident investigation proforma.
- Fall protection plan specific developed for the task and hazards, identified (excavations also posing fall risks).
- Copies of registers and inspection sheets (Work file).
- MSDS'e for all hazardous chemicals on site
- COVID-19 controls

Before the PC appoints a contractor, the PC must ensure that the contractor is competent for the task, is in good standing with the Compensation Commissioner and has the resources to execute the task safely. Refer CR 7(1)(c). The PC to ensure that:

- The contractor is registered and in good standing with the workman's compensation (COIDA) commissioner, if not, the PC must register the C, and pay the levies required. (COID Act 89)
- The PC will issue applicable sections of the project specification and sections of its own SHE plan as safety guidelines to each contractor to ensure work on-site is done according the required standard.
- The contractor appointed a qualified Health & Safety representative that will assist the supervisor in doing the applicable registers & checklists.
- The project PC will be responsible to approve the appointed contractor safety files
- The project PC will assess and audit the (sub) contractor file before allowing the contractor starting on the project.
- The project PC will do monthly audits on the (sub) contractors and send the audits on a monthly basis before 25th of each month
- The project PC safety officer will carry PTW (permit to commence) to ensure the (sub) contractor conduct the task to meet the project standard.

The PC will keep an updated register with relevant data of all contractors appointed for the project. The register must contain the date of appointment, the status of the file audit, reference to legal documentation (mandatory agreement and appointment). This register must keep on-site for inspection. That the PC project file is developed, kept updated and available on-site for the duration of the project. That all employees registered to work on-site receive site safety induction, are medically fit and in possession of an updated medical fit certificate. Members scheduled to work at heights, medical certificates must indicate that the member was tested and fit to conduct work at

heights. That own- (PC's) and contractor files will be audited on a monthly basis and that Non-compliance reports are forwarded to the clients agent. Prove that the Non-compliances are eliminated must be available in the file. When practical completion of the contract is obtained and issued to the client, the PC/safety officer will:

- Cancel all appointed contractors, agreements and appointment
- Ensure that new agreements are signed with the maintenance team, that the maintenance team she plan and file is assessed and that the team is controlled by a competent supervisor.
- Ensure that the project SHE file will be updated for handover to the client

Pin-up Board in site office:

The PC is required to erect a pin up board on-site to display the following:

- The PC company's Health and Safety Policy signed
- List of the emergency numbers
- The emergency and evacuation plan (map/diagram)
- The PC will display a safety organogram (in the safety file) indicating the health and safety appointments for the project. The structure will also be available on the noticeboard.
- A copy of the construction permit /Notification of construction
- **COVID 19 Policy and protocols**
- Copy of Letter of good standing (COIDA)
- Public liability Insurance Policy
- Site safety rules
- List of Plant & tools on site
- List of sub-contractor OHS compliance status

COVID 19 - Risk Assessment

- Contractor need to review their existing Risk Assessment (existing vs. additional controls for COVID-19). Clients Agent will provide revised Baseline R/A.
- Additional controls in R/A to cover e.g.: adequate supply of wash basins; cleaning materials; disinfecting work areas with hand sanitizers; access control; measurement; PPE requirements; social distancing; meeting requirements; COVID-19 training; emergency planning; hygiene; meals; breaks; medical screening etc.
- There should also be a separate Health Risk Assessment in place.
- The R/A should address specific HIGH RISK areas and describing the type of PPE to be worn, as required by task

General Record Keeping

The Principal Contractor and all Contractors must keep and maintain all the necessary Health and Safety records to demonstrate compliance with these Coherent Specifications, the OHS Act 85/1993, and the Construction Regulations (February 2014). The Principal Contractor must also ensure that all records of incidents/injuries, emergency procedures, training, planned maintenance inspections, monthly contractor audits, etc. are kept in the Health & Safety file(s) held in the site office. The Principal Contractor must ensure that every Contractor keeps its own Health & Safety file, maintains the file and makes it available on request (the file must include the Contractor's Health & Safety plan and all relevant records).

Such 'Contractor safety files' must be audited by the Principal Contractors qualified Safety Officer on a monthly basis with audit reports kept as proof and submitted to the Clients Health & Safety Agent.

Offences and penalties

Fines may be imposed on the Principal Contractor and Contractors for ongoing non-compliance with the provisions of the Client's Coherent Health & Safety Specifications, the Principal Contractor's Coherent Health & Safety Plan. Non-compliances identified during safety agent audits and visits will be categorized into one of three levels based on severity.

These will be as follows:

- Life threatening situation - an explanation in an audit report. This activity must be seized immediately and corrective measures taken.
- Serious injury possible – non-compliance will be issued with a time frame for compliance stipulated.
- Minor or no injury may result – an improvement notice will be issued.

Safety Non-conformance penalty/fines description:

Category	Non- compliance	Penalty Amount
High Risk	Unsafe working at heights (including deep excavations)	R 4 000
	Contractor performing construction without a file approval letter from Worksafe	R 4 000
	No fall arrest equipment being used	R 4 000
	Contractor performing construction without a construction permit or construction notification stamped from department of employment and labour	R 4 000
	Alcohol & Drug abuse / COVID-19 Non compliance	R 4 000
	Speeding on site	R 4 000
	Working on heights without approved fall protection plan in place	R 4 000
	Unsafe scaffolding being used	R 4 000
	Working in Unsafe Excavations	R 4 000
	Blasting operations non-compliance	R 4 000
	Medicals not in place	R 4 000
Medium Risk	Workers not wearing Compulsory PPE for task performed	R 2 500
	Contractor not reporting incident and accidents within 24 hours to Worksafe (Clients Agent)	R 2 500
	Unsafe electrical work being performed	R 2 500
	No competent first aider & Fire fighter on site	R 2 500
	No supervision on site	R 2 500
	Operator of machinery operating without applicable competency	R 2 500
Low Risk	Applicable signage is not displayed	R 1 500
	Employees driving plant & Construction vehicles while talking on the cellphone	R 1 500
	Poor housekeeping	R 1 500
	Employees not making use of the ablution facilities available	R 1 500
	Making use of unsafe ladders	R 1 500
	Environmental Spillages	R 1 500
	Employees using unsafe electrical equipment	R 1 500

The client's safety agent has the right to impose fines as described above for non-compliances as set out in the categories. The non-compliance will be issued in terms of the above to the contractor by clients designated Safety Agent. The Fines will be imposed with the idea that when a contractor receives a fine they should prove to the clients OHS agent and to the client in 7 working days how they spend that fine amount towards that specific non-compliance if possible otherwise towards any safety on site. In the case of repeated contraventions, the clients OHS agent shall recommended to stop the work to the client or the client's agent.

NOTE: Provide proof of how the fine paid to client & proof of payment to be forward within 3 working days to Clients Safety Agent.

5. Principal Contractors, Contractors and Sub-Contractors

Principal Contractor's and Contractors' Requirements

The Principal Contractor must ensure that all Contractors appointed by them comply with these Specifications, the Principal coherent Health & Safety plan as well as the OHS Act, Construction Regulations (February 2014), and other relevant legislation that may relate to the activities directly or indirectly. A Contractor, when appointing other Contractors as 'Sub-contractors', shall mutatis mutandis ensure compliance as if it was the Principal Contractor.

The Principal Contractor may only allow a Contractor to begin work on site after receiving a coherent Health & Safety plan which must include a project specific hazard identification, risk assessments and safety measures. The Principal Contractor must test competency and finally approve his sub – contractor coherent site specific health and safety plan. The Principal Contractor must audit each of its contractors on a monthly basis, with audit reports kept in the Health & Safety file on site. The audit must include an administrative assessment as well as a physical inspection of the contractor's site activities. *The Principal Contractor Representative must stop any Contractor from carrying out construction work that is not in accordance with the Principal Contractor's and/or Contractor's Health & Safety plan or if there is an immediate threat to the health and safety of persons.*

The Principal Contractor shall take all reasonable steps necessary to ensure co-operation between all contractors to enable each of those contractors to comply with the provisions of the Construction Regulations;

The Principal Contractor shall take all reasonable steps to ensure that each contractor's coherent health and safety plan is implemented and maintained on the construction site: Provided that the steps taken shall include periodic audits at intervals mutually agreed upon between the Principal Contractor and contractors, but at least once every month;

The Principal Contractor must ensure that where changes are brought about to the design and construction, that sufficient health and safety information and appropriate resources are made available to contractors so as to allow them to execute the work safely;

The Principal Contractor must ensure that every contractor is registered and in good standing with a recognised compensation fund or with a licensed compensation insurer prior to work commencing on site;

The Principal Contractor must ensure that potential contractors submitting tenders have made provision for the cost of health and safety measures during the construction process;

The Principal Contractor shall discuss and negotiate with the contractor the contents of the coherent health and safety plan and shall finally approve that plan for implementation;

The Principal Contractor shall hand over a consolidated health and safety file to LIMPOPO DEPARTMENT OF PUBLIC WORKS: ROADS AND INFRASTRUCTURE upon completion of the construction work and shall include a record of all drawings, designs, materials used and other similar information concerning the completed structure;

The Principal Contractor may only appoint a contractor to perform construction work when such Principal Contractor is reasonably satisfied that the contractor he or she intends to appoint, has the necessary competencies and resources to perform the construction work safely and that the contractor is an approved Client contractor.

The principal contractor must ensure that all employee shall have an induction sticker on their hard hat to show they have received induction with the date and site name, see example bellow:



The Principal contractor will ensure that every employee on site will have a valid ID copy available in the safety file. All workers to receive proof of safety induction (sticker on hard hat).

Principal Contractor / Contractor Competency Assessment

The Principal Contractor must be reasonably satisfied that the contractors it intends to appoint have the necessary competencies and resources to safely conduct the work they will be appointed for. This should be established at tender stage and before appointments are made. One of the preferred ways of determining whether a contractor is competent is to make sure the contractor is an accredited contractor for Client. Once the contractor is appointed, but before it begins work on site a site- specific safety plan must be discussed and negotiated with the Principal Contractor. Such safety plan must be approved for implementation by the Principal Contractor.

The Principal Contractor and Contractors should submit the following documentation for perusal and verification by LIMPOPO DEPARTMENT OF PUBLIC WORKS: ROADS AND INFRASTRUCTURE and Principal Contractor respectively:

- Coherent Health & Safety plan as compiled for this project; (including Risk assessments, safe work procedures, fall protection plan
- Management Structure as envisaged at tender stage (organogram);
- Letter of Good Standing with the Compensation Commissioner or FEM;
- Proof of Health & Safety training and other related training; (CV and certificates) Legislative appointment letters
- Medical certificates of employees that will be working on site on annexure 3 format stamped by Occupation Health Practitioner (should be registered).
- Notification of Construction work; (proof notification was done)

Pricing for Occupational Health & Safety Compliance

All parties bidding to do work on this construction project must ensure that they have made provision for the cost of complying with this Specifications document as well as with the OHS Act and incorporated Regulations as a minimum requirement in their tender documentation. It must also be taken into consideration that time is money, which implies that sufficient time must be allowed for the implementation of the minimum OHS standards. No additional claims will be entertained at a later stage should a compliance requirement be prescribed in the OHS Act, incorporated regulations or in this Specifications document due to design changes which would require additional resources. The Employers Agent must develop a strategy in this regard to ensure that H&S costs have received sufficient consideration. Contractors must make use of **Annexure 'C'** herein below as a guide when pricing Health & Safety on this project including COVID-19 Legal Requirements. Health & Safety costs must be clearly set out in the tender submission by each and every contractor. **The contractors shall also make provision for COVID 19. This provision need to be approved by the client or client's agent.**

Contractors' Coherent Health & Safety Plans [Construction Regulations 7]

Introduction:

The Construction Regulations (2014) aims to improve overall management and co-ordination of Health, Safety and Welfare throughout the Construction Phase and reduce the large number of serious and fatal injuries and cases of ill health, which occur every year in the Construction Industry.

In terms of the Construction Regulations (2014), the Principal Contractor is required to develop a Health and Safety Plan before work commences on site and review it throughout the Construction Phase. The degree of detail required in the Health and Safety Plan and the time and effort in preparing it should be in proportion to the nature, size and level of Health and Safety risks involved in the project. Projects involving minimal risks will call for simple, straightforward plans. Large projects or those involving significant risks such as this project will need much more detail.

What should the construction Health & Safety plan cover?

The Construction Health and Safety Plan should set out the arrangements for ensuring the Health and Safety of everyone carrying out the construction work as well as all other persons who may be affected by it. The index of this file/plan must be in line with Annexure D guideline index.

Communication and Management of the work

The Principal Contractor must indicate in its health and safety management plan that it has made provision for the following:

- Management structure and responsibilities
- Health and Safety goals for the project and arrangements for monitoring and review of Health and Safety performance i.e. safety meetings; contractor meetings; risk assessment review, etc.
- Site specific rules and procedures.
- Arrangement for:
 - i. Regular liaison between parties on site i.e. meetings (Monthly OHS Meetings)
 - ii. Consultation with the work force i.e. toolbox talks
 - iii. The exchange of design information between LIMPOPO DEPARTMENT OF PUBLIC WORKS: ROADS AND INFRASTRUCTURE, designers, and Contractors on site
 - iv. Selection and control of Contractors i.e. selection criteria; inspections; audits, etc.
 - v. Site Health & Safety induction and onsite training i.e. toolbox talks
 - vi. Welfare facilities, first aid, emergency planning and fire prevention strategy
 - vii. The reporting and investigation of injuries and incidents including near misses what the intended system will be
 - viii. The production, approval and review of risk assessments, safe work procedures and method statements and how does the company's risk assessment system work.

6. Client identified hazards and potentially hazardous situations

OHS Agent High Risks identified (Baseline R/A provided as separate document)

- Existing services
- Interface with the public (traffic accommodation)
- Hazardous chemical such as solvents, cleaning agents, cement, fuels, oils, epoxies, etc.
- Site security and access control issues

- Relocation and protection of existing services
- Blasting activities (dust control); blasting under existing powerlines
- Electrical lock-out: Movement of distribution boxes
- Traffic circle construction: Management of public
- Potential snake bite or scorpion sting risks
- COVID-19 general site risks

Unforeseeable Hazards

The Principal Contractor must immediately notify Contractors as well as LIMPOPO DEPARTMENT OF PUBLIC WORKS: ROADS AND INFRASTRUCTURE, in writing, of any hazardous or potentially hazardous situations that may arise during the performance of construction activities so that the necessary precautions may be taken before such work begins.

7. Site operational Requirements

7.1. Health and Safety Representative

The Principal Contractor and all Contractors must ensure that Health and Safety Representative(s) are appointed under consultation with the employees. The H&S representatives must be competent to carry out their functions. The appointments must be in writing. The Health and Safety Representatives should carry out monthly inspections, keep records of the inspections and report all findings to the Responsible Person or safety officer forthwith and at monthly Health & Safety committee meetings. At least one Health & Safety representatives is required by all Employers on site.

The Principal contractor must ensure for every 1 – 20 employees at least one Health and safety representative is appointed. Every specific section must have a health and safety representative for example civil construction work and electrical work activities. The solution will be that every contractor appointed will have their own health and safety representative that has knowledge in that specific section.

7.2. Health and safety committees

The Principal Contractor must ensure that project health and safety committee meetings are held monthly with minutes kept. Meetings must be chaired by the Principal Contractor's Responsible Person [CR 7(1) person]. All Contractors' Responsible Persons and Health & Safety Representatives must attend the Principal Contractor's monthly Health & Safety meetings. The Principal Contractor's appointed supervisors must also attend Health & Safety meetings. The following topics must be tabled at meetings: management appointments and risk management portfolios; sub-contractor legal compliance issues; injuries and incidents; hazards and risk assessments (present and foreseen); safety procedures; method statements for upcoming activities; planned inspections and registers/record keeping, etc. The committee chairperson must sign off and date of the minutes (see template attached to this Spec Annex G).

7.3. Health and safety training

Induction Training:

The principal contractor will ensure that all the employees, contractors, professional team members and visitors received site specific safety induction. Record of attendance will be kept in the health and safety file. (OHS Act sec 13). A record of attendance must be kept in the Health & Safety file. Workers must carry proof of inductions as described under point 5. Employees shall have

induction stickers as displayed above in the spec that will be issued by the safety officer on site.

Awareness

The Principal Contractor will ensure that on-site toolbox talks/safety talks are scheduled for once a week. These talks will be conducted by a senior member or the safety officer of the company and focus on topics relevant to the task, the hazards of the activities identified for the week's programme. A documented record of attendance will be kept in the health and safety file. The toolbox talks will not replace any certified training or a DSTI. All contractors' employees must attend safety awareness toolbox talks carried out by their supervisors, the signed attendance registers must be copied to the Principal Contractor together with information as discussed in training session.

Competence

Competency training is the training conducted where the course is developed to a SAQA standard or tertiary education/qualification. All competent persons must have the knowledge, experience, training, and qualifications specific to the work they have been appointed to supervise, control and/or carry out. This must be assessed on a regular basis e.g. training, evaluation, and periodic audits by Department of Economic Development, Environment, Conservation and Tourism, progress meetings, etc. The Principal Contractor is responsible to ensure that Competent Contractors are appointed to carry out construction work on site. If the unforeseen training has arisen then the matter can be resolved with the client's OHS agent appointed for the project. Act "General duties of employers to their employees". Sub-paragraph (e) of sub-section 2 requires inter alia the training of the employees take preference.

7.4. Health & Safety audits, monitoring and reporting.

The Client's OHS Agent shall conduct at least one legal safety compliance audit per month. This safety audit will be on the systems and processes put in place by the principal contractor. The safety audit will be sent to the client within 48 hours from the time of the audit. Note that this audit will happen at any time during working hours and that the OHS agent does not need to make an arrangement to conduct the audit. The principal contractor shall do an audit close-out within 3 days from receiving the audit (action plan to mitigate non-compliance items).

The Principal contractor will be required to do a monthly audit on all contractors and send the audits to the OHS agent before the 25th of each month (template will be provided).

7.5. Emergency procedures

The procedure must detail the response procedures including the following key elements:

- List of key competent personnel (Emergency coordinator)
- Details of emergency services in local area
- Actions or steps to be taken in the event of the specific types of emergencies
- Evacuation procedures: including routes and exits to be available on a drawing (site lay-out not only in the camp).
- Emergency procedure(s) must include, but shall not be limited to: fire; spills; injury to employees; damage to material / equipment / plant; use of hazardous substances; bomb threats; major incidents/injuries; evacuation; etc.
- The Principal Contractor must advise LIMPOPO DEPARTMENT OF PUBLIC WORKS: ROADS AND INFRASTRUCTURE in writing forthwith, of any

emergency situations, together with a record of action taken/action to be taken.

- A contact list of all service providers (Fire Department, Ambulance, Police, Medical and Hospital, etc.) must be maintained and made available to site personnel.
- The emergency plan will need to be reviewed from time to time as conditions/environment changes i.e. as building work increases in extent.
- An emergency map layout that clearly shows where is the emergency assembly points is with all the fire fighting equipment
- Emergency plan shall include community unrest and what to do during this hazard

An emergency drill shall be done in the first quarter of the construction phase. The principal contractor shall have footages available as well as attendance register to have proof of the drill.

7.6. Medical certificate of fitness

The Construction regulation 7.8 requires that all employees including Professional team members on site shall have a valid medical certificate of fitness. The medical shall be done by a registered Occupational Health & Safety medical practitioner. The Construction Regulation of 2014 requires that every medical certificate shall be recorded on an Annexure 3 format to ensure that the medical is done for the task specific scope. The medical fitness certificate will be invalid if no expiring date is presented on the form.

7.7. First aid boxes and first aid equipment

The Principal Contractor and all Contractors must appoint First Aider(s) (Level 1) in writing. The Principal Contractor must appoint at least one First Aider to start with, which first aider must be certificated. Copies of valid certificates are to be kept on site. The Principal Contractor must provide at least 1 (one) first aid box, adequately stocked at all times. Due to the nature of this project i.e. satellite work stations/areas, further first aid boxes must be provided close to the various work stations to allow for quick, effective treatment of injured persons. As the work progresses and the structure increases in height, extra first aid.

7.8. Personal protective equipment (PPE) and Clothing (PPC)

The Contractor must ensure that all site workers are issued with and wear the appropriate PPE as indicated in their risk assessments. The Contractors must make provision and keep adequate quantities of SANS approved PPE on site at all times according to their risk assessments. Safety harnesses are mandatory wherever work takes place in an elevated area where safe working platforms or ladders are not possible. Eye protection must be worn by those working grinders, skill saws; jack hammers/rock breakers etc. Even those workers in close proximity to these operations will also be required to wear such eye protection. **The COVID 19 regulation requires that the principal contractor shall issue each employee with at least 2 overalls. Each employee shall receive 2 cloth masks free of charge.** Employees must wash the cloth mask after each day of work and use the clean one the next day. No bump caps will be allowed on site as means of head protection.

According to DoEL directive nr 3, no General Fabric Masks with breathing valves and Fabric Neck Buffs will NOT be allowed on site (see point 11.5). The principal contractor shall have visitors PPE available at the site office should site visitors not have the compulsory PPE to access the site. No bump caps shall be allowed on site.

7.9. Occupational Health and Safety signage's

The Principal Contractor must provide adequate on-site OHS signage including COVID-19 Awareness posters at workers areas such as eating area.

Including but not limited to: 'construction work - no unauthorised entry', 'beware of overhead work', 'hard hat area', first aid – to be posted up at all work areas/zones. Contractor should provide Contractors Safety Board at entrance to the site.

Signage must also be posted up at strategic locations to warn the public of diversions, alternative through ways and other irregularities caused by construction work (pedestrians and motorists) Signs are also required as per law e.g. scaffolding and other potential risk areas/operations such as exposed edges and openings and trenches / excavations where persons are at work. Safety signs and awareness posters will also be required in strategic locations on site such as frequently used access routes, stairways and entrances to structures and buildings where the workers will continuously be made aware of Health & Safety. Health & Safety signage must be well maintained including weekly inspections, cleaning, replacement and repair. COVID 19 awareness posters shall be posted all over site by the principal contractor to ensure that the employees stay aware and stay safe.

7.10. Site hording & Access control (Site camp area)

All construction work must be fenced off with controlled access points provided (this means locked access gates and access control personnel to be located at entrances to the construction work areas), preventing access to unauthorised persons. Where fencing is necessary, such fencing must be at least 1.8m high, erected and adequately secured from displacement. It is further required that the fencing is fitted with shade cloth to assist with dust containment (green shade netting material).

Contractor access to the construction work areas will be limited to the specified access routes as agreed with the Client and must be strictly enforced by the Principal Contractor.

All access points to site must carry the necessary signage and site manager's (and safety officer) contact numbers.

COVID 19 procedure need to be followed with each person entering the site: Scan, Sanitize, Access control personnel complete sign in register, Access control personnel complete COVID 19 medical questionnaire. NO MASK NO ENTRY

7.11. Night Work (After Hours)

No night work will be allowed within the hazardous zone on this project without prior approval from Client / Client's Agent and the Construction Health and Safety Agent. If the Night work has been approved by the client and the client's agent additional documents will need to be in place for example: Employees medicals on annexure 3 must specify that they are fit for night work, sufficient illumination etc. Principal contractor must ask permission 5 working days in advance when they are planning to working at night. Principal contractor & Contractor will only be allowed to commence with night work once the documents has been approved by the clients OHS agent.

7.12. Transport of workers

The principal contractor will not be allowed to transport any workers with tools or material in the same compartment. Separated compartment for tools must be available to prevent that no tools & material fall on employees in case of an accident. No employee will be allowed to be transported if he/she is not seated in a proper seat with a seatbelt approved & tested by the road department.

Persons not allowed to be transported on a truck/vehicle together with goods or tools unless there is an appropriate area or section to store the tools or equipment; Contractors must adhere to the National Road Traffic Act.

7.13. Fatigue management

The first step in risk management process is to identify all reasonably foreseeable factors which could contribute to and increase the risk of fatigue. The principal contractor shall have a site-specific fatigue management plan available on file. Fatigue is often caused by a number of inter-related factors which can be cumulative. Common factors that may contribute to fatigue are:

- Work schedules which limit the time workers can physically and mentally recover from work
- This may include workers who undertake shift work, night work, work extended hours or are not able to take regular breaks
- Sleep, including the length of sleep time, the quality of sleep and the time since sleep
- Environmental conditions, such as exposure to heat, cold, vibration or noise, can make workers tire quicker and may impair performance
- No-work related factors, such as a worker's lifestyle, family responsibilities or health may all increase the risk of fatigue

Methods that managers may utilize to identify whether there are any of the above risk factors affecting the workers include:

- Consulting with workers
- Examining work practices and systems of work
- Incident data and the findings of incident investigations
- Seeking advice and information from the Team or other relevant experts

7.14. Illumination

Illumination on a construction site is critical. The principal contractor shall ensure that the employees have a safe workplace to work to with sufficient illumination. No employee will be allowed to work in a part of a building if sufficient lighting is not available. Poor lighting is not just only a hazard but the quality of work can also be influenced. Road work risks should be properly illuminated at night time. No road crossings may be done during night time.

The contractor shall at all times comply with the environmental regulation for workplaces. The regulation states exactly what the sufficient lux is for the specific workplace.

8. Physical Site Safety Requirements

8.1. Site establishment

Access control to the site, including notices of "construction-site " or "be aware of constructions activities" and "visitors to report to the site office" to be installed. COVID-19 access to be implemented, no screening, recording - no access

Identify a safe laydown area and layout of the contractor's containers/sheds to ensure the safety of tools, material and equipment. Display of evacuation signage to point out the route to the assembly. Effective barricading of engulfment areas, and installation of the appropriate signage.

Also ensure that laydown areas:

- Are equipped with correct serviceable fire extinguishers and signage.
- The safety and safe keeping of contractor's equipment, tools and materials remain the responsibility of the contractor.
- The PC and contractors to apply sound and good housekeeping principles for the duration of the project.

Physical site security, security lighting and guards to be considered and applied or implemented.

Laydown plan need to be submitted to the clients agent and to the clients OHS agent for approval 5 working days before site establishment. (Included in Contractors SHE Plan).

8.2. Blasting – NOT REQUIRED AS PER SCOPE

The following protocol should be followed when blasting activities are being performed:

8.2.1. BLAST MANAGEMENT

Every blasting operation must have a "Blaster-in-Charge" (BIC). This individual has overall responsibility for all aspects of the blasting operations. Prior to any blasting, the general and site-specific blasting hazards and environmental impacts must be defined for each blast site. Blasting plans and procedures must incorporate all reasonable measures necessary to eliminate negative impacts on persons, property, and the environment.

No explosive storage on-site allowed as per Explosive Act & Regulations.

In blasting design there are generally two major considerations: safety concerns and operational concerns. Safety concerns should always come first.

NOTE: ALL BLASTING OPERATIONS IN ACCORDANCE TO EXPLOSIVES ACT 26 OF 1956 AND EXPLOSIVE REGULATIONS 109. ALL BLASTERS TO BE REGISTERED WITH DoEL

8.2.2. PRE-BLAST REVIEW MEETING

Before blasting, the Blaster-in-Charge should assemble all blast crew personnel to review the blast area security plan and blast emergency plan. The blast area is the area in which there is any potential for flying material, air over-pressure, or gases from an explosion to cause injury to persons. The Blaster-in-Charge should cover the following issues:

1. Acknowledge the shot is properly loaded, hooked up, secured, and ready for detonation.
2. Review the blast firing time schedule.
3. Review the direction of the blast movement, and define the blast area for security purposes.
4. The Blaster-in-Charge should specify who should fire the shot and define the safe shot initiation location.
5. Review the communication system that should be used between the Blaster-in-Charge and all blast area security personnel.

6. Specify what signals should be used to announce:
 - a. Pre-blast warnings
 - b. Blast time
 - c. All clear
 - d. Blast countdown suspension
7. Outline general emergency plans that should be used in case of an accident or other unplanned event.
8. Review procedures for handling misfires.
9. Confirm all warning signs have been posted

The Blaster-in-Charge should coordinate blasts, with all concerned parties, on an approved schedule. To do so, clearing and guarding procedures must be set, communicated, maintained, and evaluated.

1. A safe area around the shot area should be determined and cleared. Guards should be assigned to secure all possible entryways into the blast area.
2. The Blaster-in-Charge should be in constant radio communication with all personnel during the clearing and guarding operation.
3. When all guards confirm that the area is secure, the Blaster-in-Charge should connect the primary initiation device 5 minutes before the scheduled blast time.
4. The 5-minute blast warning signal should then be sounded.
5. Four minutes later, the 1-minute blast warning signal should be sounded.
6. At blast time, the Blaster-in-Charge should fire or instruct the designated shot-firer to fire the blast.
7. After the post-blast fumes have dissipated to safe levels, the Blaster-in-Charge should inspect the shot area. During the examination the blaster should look for:
 - a. Dangerous rock conditions.
 - b. The presence of undetonated explosives, and/or initiators.
 - c. Abnormal blast conditions and any other hazards.
8. All misfires should be safely removed, and other hazardous condition corrected or secured.
9. When the area is clear of hazards to nearby traffic, the public, or the job site personnel, the Blaster-in-Charge should give the all-clear signal and relieve the guards from their posts.
10. An approved lightning detector should be used to monitor approaching electric storms. All precautions should be taken in the event of a storm.

8.2.3. MISFIRE PROCEDURES

When blasting misfires occur—or are suspected—the misfire procedures plan should be initiated. The Blaster-in-Charge should determine the affected area.

1. No one is to enter this area for at least 30 minutes.
2. Only the minimum required people should enter the area to safely re-fire, wash out, or recover un-shot explosives.
3. Record the location of any potentially undetonated explosives on the blast report.
4. Expand the blast security area if flying rock potential is increased when misfires are re-blasted.

8.2.4. BLAST EMERGENCY PLAN

The elements of specific blast emergency plans should vary based on the unique site conditions. The plan as a minimum should include the following.

1. Post all emergency response telephone numbers, including medical response, OSHA, MSHA, fire department, police, state regulatory authorities, home phone numbers of all site supervisors and workers.
2. Plan should be clearly communicated and understood by all personnel.
3. Define notification procedures and their timing.
4. Identify location of first-aid kits and identify first-aid providers.

8.2.5. BLAST REPORTS

Individual blast reports should be prepared for each blast. Blast reports should include the following.

1. Blast date, time, and location
2. Weather and environmental conditions, such as wind speed and direction.
3. Blast geometry: hole size(s), hole depth, drill pattern, number of holes, bench height, and sub-drilling.
4. Blast hole loading summaries: typical hole loads, explosive types, primers, detonator delays, stemming type and quantity, as well as total explosive utilized, by product.
5. Shot volume and powder factor calculations.
6. Initiation timing schemes: in-hole delays, surface delays, and planned hole firing times.
7. Blast effect monitoring data (such as ground vibration levels, air-over-pressure measurements).
8. Notes about blasting results.
9. Name and signature of blaster-in-charge.

8.2.6. RISK MANAGEMENT

Risk management in blasting work is increasingly becoming more challenging as work inevitably occurs in more populated areas. Not only is the work closer to people and structures, but concern about blasting effects on animals and utilities are also increasing. Sometimes it is possible to use mechanical methods to excavate rock, but these are slower, costly, and may still have vibration issues. Regardless of the scale of the blasting work, sometimes engineers and contractors underestimate the importance of preparing blasting controls and public relations programs. The consequences of this are often severe.

8.2.7. PUBLIC PERCEPTIONS

The public's perception of blasting has been forged from scenes in movies like *Die Hard* and *Apocalypse Now*. People do not want blasting occurring, or explosives stored, near their homes. Some recent tragedies with explosives have created genuine fear amongst the general public. In light of these liabilities and public relation issues, it is imperative to ensure that the blasting plan is as fool proof as possible, and the public informed about the work planned for the site and educated about blasting, its effects, and the controls put in place for everyone's protection.

For most projects, engineers develop blasting specifications designed to ensure that blasting is done safely and in conformance with project requirements. The quality and thoroughness of the specifications can greatly affect the outcome of the project. In most cases, risk is transferred by contract clauses, but in some serious cases, owners and others have become embroiled in legal action and have ended up with financial losses.

Contractors and blasters usually understand the risk associated with the work. Occasional accidents and incidents, such as flying rock and premature detonation, are the result when blasters do not employ adequate blast design and control practices. Along with these well-known risks, there are secondary risks such as vibration and air overpressure that result from blasting operations. Other issues that may have some impact may involve explosives storage and transportation.

8.2.8. MANAGING BLASTING RISK

Engineers and planners can use the following approach to manage blasting risk. First, ensure that the project design is practical. Second, define prequalification requirements for the contractors who are to bid on the project. Third, develop specifications that clearly define performance and safety requirements for the work. Fourth, ensure that the work is overseen by capable personnel.

Safe blasting requires four basic elements:

1. Proper design
2. Specification
3. Prequalification
4. Oversight

Unless property is damaged by flying rock, most claims of damage caused by vibration and air overpressure are "perceived" damage claims, where observed damage may have been caused by other conditions such as settlement, poor construction, weathering, differential temperature, and humidity.

8.2.9. PUBLIC RELATIONS

All blasting projects—large or small—occurring near any concerned neighbours, require some level of public relations work. The level of this public relations (PR) work is a function of the blasting duration, timing, and the level of concern by the neighbours. Engineers and designers understand that it is unlikely that the planned blasting will cause any real injuries to the neighbours or damage their property. Because of this belief, it is sometime hard for them to become enthused about PR work. The neighbours, however, have a different impression of explosives, which is gained from popular TV, movies, and well-publicized accidents or disasters. So, ignoring the public is to invite potential delays and eventually costly legal action. Dust control plays a very important role when blasting.

8.2.10. ISSUES OF CONCERN

Generally the neighbours' areas of concern fall into three categories:

- Noise
- Vibration damage
- Dust control

8.2.11. PRE-BLAST AND AFTER-CLAIM PROPERTY CONDITION SURVEY

Pre-blast surveys are an extremely important tool for prevention of blasting complaints and subsequent damage claims. In many cases, pre-blast surveys lower the project liability risk, as well as serve as a venue to educate the neighbouring public. A professionally performed survey also will influence the attitude of the adjoining property owners. Depending on the project, the area surveyed can be as close as 300 feet or half a mile and greater.

Pre-blast reports should include written notes, photographs, or video, and in some cases, diagrams and measurements to classify existing conditions. Settlement surveys by independent firms may also be necessary. The surveyors should be given some PR training so that they may effectively start the public education process.

8.2.12. CONCLUSION

It is important to understand that risk management starts well before the blaster shows up for work on the project. Engineers and planners must ensure that the project design is practical. The contractors are prequalified to ensure that they are capable to successfully perform the work. The specifications must clearly define the performance and safety requirements of the work. And that the work is overseen by qualified and capable construction personnel at all levels. The following documents will be submitted to the Provisional Department of Labour (Polokwane) 48 hours before the blast:

1) Notification Letter: DoEL (48 hours)	11) ER 12(4)(a)(i) Rules/Methods/Materials & Equipment and tools used in Danger Area
2) Indicate area of blasting	12) Charging up procedure
3) When (time)	13) Firing procedure explained
4) Blasting Plan	14) Misfire procedures explained
5) Area Plan	15) Schedule licenses? Explosive Manager
6) Safe area / Danger Zone	16) Drawing of Emergency Procedures
7) Indication of detonation area	17) Type of cover to be used
8) Type of rocks	18) Letter of Good Standing
9) Explosive storage	19) Emergency Procedures/Plan
10) Process to be followed / method	20) Surrounding Notification

IN ADDITION TO ABOVE DOCUMENTS THE BLASTER WILL INCLUDE FOLLOWING DOCUMENTS IN SAFETY FILE (ADDITIONAL DOCUMENTS):

1) Registration with SAPS	11) Medicals for Blasting Personnel
2) Permit for transporting explosives	12) Incident procedures?
3) Blasting Permit	13) Recording of Incidents (WCL 2: Annex 1)
4) CV of Blaster: Competency	14) Work file: Checklists
5) CV of Blasting Manager: Competency	15) MSDS list & proof of inductions
6) Risk Assessments for Blasting work	16) Toolbox talk register & topics
7) Mandatory Agreement 37.2 with P.C	17) Pre-blast checklist
8) Method Statements? Charge Up Procedures	18) Post-blast inspection checklist
9) Legal Appointments as per Organogram	19) Pre-blast meeting conducted
10) Employee registers & ID's	

Note: The Blaster should notify the Chief Inspector of DoEL within 48 hours (Blaster file approval) and cannot start with any blasting activity if approval not granted by DoEL in writing.

8.3. Borrow pits

The principal contractor shall ensure that method statements is available for the borrow pits and all the activities that is included in the allocated borrow pit area. Mine appointments shall be in place for the borrow pits and will be confirmed by the client OHS agent with the monthly legal audit. The following appointments will need to be in place: Mine Manager appointment, Mine Health & Safety officer appointment & all the operators shall be appointed on the mine mobile plant operator appointments. The access to the borrow pit will be controlled by a control officer where each and every visitor shall sign the register before entry, No person shall enter the borrow pit if he/she do not have a rotating light fitted to the vehicle and are in the possession of a reflective vest & safety boots. The borrow pit shall be fenced with at least 1,8 M fence to ensure that the community and animal cannot obtain access. The applicable signs shall be visible at the access of the borrow pit as well as on each side of the borrow pit on the fence. All mobile plant that are working in the borrow pit shall have rotating lights as well as acoustic waring devices in place to warn employees that the plant is moving backwards. When the borrow pit is not used (after hours) the borrow pit shall be locked. The mine manager shall ensure that as the material is removed that the operators makes provision for water drainage from the excavated areas to prevent water damming and creating a drowning risk. The principal shall submit a rehabilitation plan when they are nearing the end of the borrow pit use. The principal contractor shall ensure that the borrow pit is secured with a fence and have controlled access until the environmental consultant / clients principal agent signs of the rehabilitation of the borrow pit.

8.4. Principal Contractor Construction board

The Principal contractor shall place a construction notice board at the site access road. If the site is not camped off then the board will be placed at the site office or the most used road on the construction site. The contractor shall display the major hazards on the board as well as the construction manager, construction supervisor and the safety officer cell numbers. This will assist the public that if an emergency happens that they will be able to make contact with site management. The construction board shall be at 1,8m by 1,2 m on cromadec or ABS sheet. Below is an example of a contractor board that is explained above:

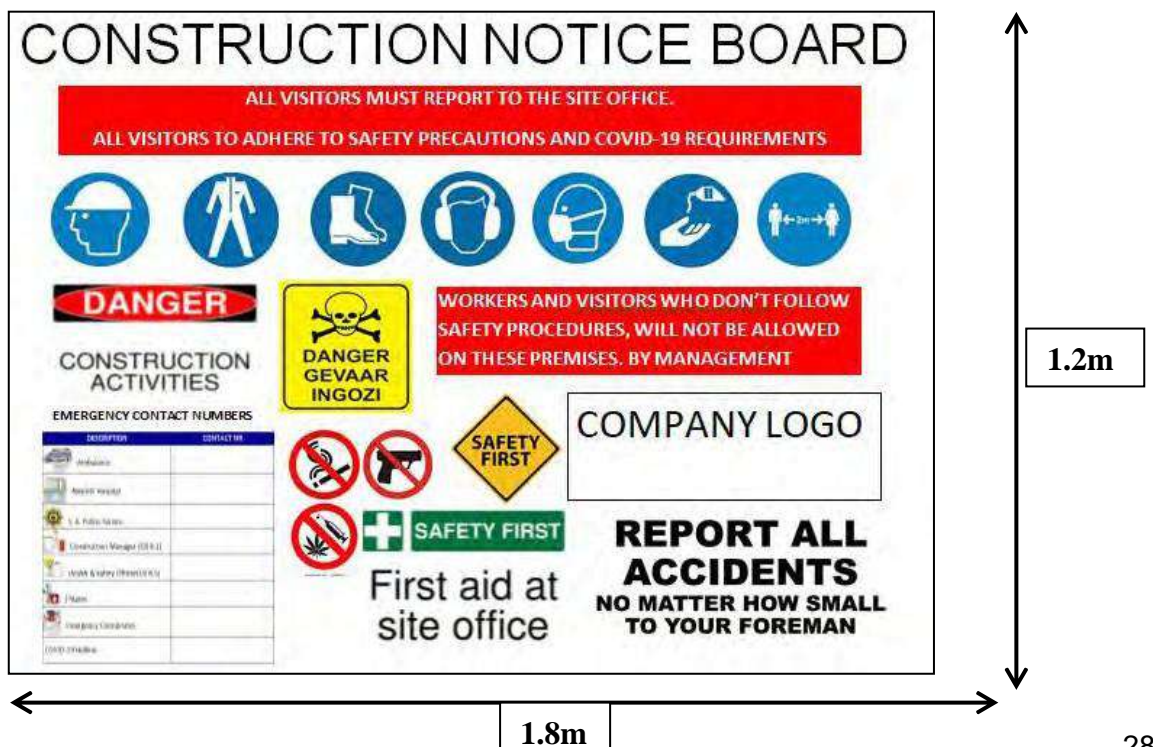

8.5. Existing structures CR 11

The PC will ensure that the provisions of the regulation CR 11:2014 are met and record is kept of inspections carried out by a competent person of the integrity of the structure and the following:

The drawings pertaining to the design of the structure are kept on-site and are available on request of an inspector, client or representative and employees. That project drawing issued complies with the requirements as displayed in SANS 10400 Part A e.g. displaying the required signage, notes, dated and signed by the draftsman and responsible person and stamped "issued for construction. That the structure is inspected and any signs of damaged reported to the structural engineer. The construction manager must ensure that no structure or part of a structure is loaded in a manner which would pose a risk of collapse. Records of all inspections must be kept in a register onsite . Before demolishing of a structure, that the structural engineers method statement is received and studied to ensure the support. Structures supervisor shall be appointed in writing with CV and proof of qualifications attached.

8.6. Underground and internal services

The P/Contractor must ensure that all existing internal and underground services are known before starting any demolitions or excavation work on site. Where Way Leaves are required, they must be applied for by the P/Contractor and will serve as indications of the relevant services. Should the location of services (electrical, water, sewer, etc.) not be known, are deemed to be inaccurate, or if it is suspected that services might be present, the Client must mandate the Contractor to make use of the necessary detection equipment in order to accurately. When possible drawings of services shall be obtained by the principal contractor from the local municipality.

8.7. Demolition CR 14

Any Contractor carrying out demolition work must ensure that prior to any such work being carried out, and in order also to ascertain the method of demolition to be used, a structural engineering survey of the structure to be demolished must be carried out by a competent person and that a method statement on the procedure to be followed in demolishing the structure is developed. It is required that a detailed demolitions method statement be included as a tender returnable document for assessment by the consulting structural engineer and clients OHS agent appointed to the project.

In addition to CR14 the following measures must also be adhered to:

- The Contractor must appoint a competent person in writing to supervise and control all demolition work on site;
- No demolition work may be carried out until the risk of injury and property damage has been identified, assessed for risk, and such risk of injuries and property damage has been eliminated, and proven to the consulting structural engineer and/or similar engineer i.e. appointed by the demolitions contractor;
- The Contractor must ensure that any partly demolished structure does not pose a safety risk to workers or members of the public;
- Should the Contractor be in doubt about the safety of a partly standing structure, the structure must be demarcated at a reasonable distance and sign posted, warning persons of the risk until such structure is made safe;
- The Contractor must ensure that no persons work, move or stand under any partly demolished overhanging material, which has not been adequately shored, braced or supported;

- Any support work must be designed to withstand the load being imposed on it, the design must be held on site;
- Where the stability of an adjoining structure, building or road may be negatively impacted, the Contractor must take all necessary steps to ensure the stability thereof;
- The Contractor must ascertain the location and nature of electricity, water, or other similar services, which may be affected by the work being performed. A safe method of removal or work around these services must be drawn up;
- Safe and convenient access must be provided to all work areas – scaffolding, ladders, etc.;
- While demolition is taking place, all unauthorised persons must be kept well away from the operations;
- The Demolition Contractor's safety plan must include what applicable personal protective equipment and clothing is required. The minimum being leather gloves; steel toecap boots; eye protection where the risk of eye injury exists i.e. cutting, grinding, hot work, impact work; hearing protection for operators and other workers exposed to noise over 85dB(A); and fall prevention and/or arrest equipment when the risk of falling exists.
- The suppression of noise and dust is important due to worker exposure as well as sensitivity to neighbouring premises.

Demolition must take place in Chronological sequence:

- Planning and hoarding of demolition site
- Demolishing and stripping by hand example: removing all non structural items (soft stripping)
- Demolition of brick walls and structures
- Remove rebar from building rubble before removing to a registered dumping site

8.8. Earthworks (Civil works) CR 13

The PC will ensure that the provisions of the regulation CR 13 are met and ensure that earthworks are carried out as per the design. Further that:

- Before conducting any earthworks ensure that way leaves is obtained and taken into consideration for the protection of services, further that:
- The project area is secured, fenced and warning signs of construction activities, installed. Other access routes to be clearly marked with signage indicating "Construction No Access"
- That the construction board is installed at the entrance displaying the PPE requirements with clear route to the site office.
- That land clearance and ripping is done following the design drawing and rubble kept in an area assessed as laydown area.
- That surveyor pegs and benchmarks are clearly marked and protected to prevent the accidental removing and clearing of land between incorrect coordinates.
- That the PC assess wild animals and take the necessary precautions to ensure the safety of the employees.
- That the PC ensure the appoint a security company to react on civil unrest or criminal activity onsite.
- That the PC will assess and take preventative action to protect water environment, wetland, rivers or storm water inlets.
- That the PC will remove trees as per agreements and with the authorization of the client.

Retaining walls

- Retaining wall shored/braced and secured as per assessment of dangerous works Retaining walls and brick work secured on firm foundation
- Retaining walls and soil to meet the required compaction requirements
- Retaining walls to be secured with solid barricading to prevent accidents

8.9. **Excavations CR13**

Once the Principal contractors starts with excavations & trenches and these are deeper than 500mm the excavation shall be barricaded with barrier netting example as below. If the excavation is deeper that 1,2 M every 6 M apart from the employees there shall be safe means of access & egress. No Danger tape will be allowed on site only orange snow net material.

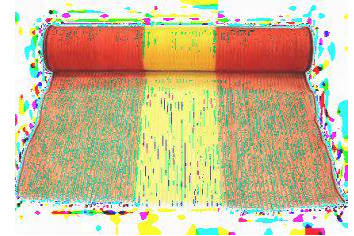

The Principal Contractor and relevant Contractors must make provision in their tender for the shoring of excavations where the soil conditions warrant it or if this is not possible batter back such excavations to a safe angle, termed the safe angle of repose (to the discretion of the Clients/Employers Agent).

The Principal Contractor has the following options: shore or brace the excavation, should this not be practical then such excavation must be battered back to the safe angle of repose from the engineer's recommendation, should the first two options not be deemed necessary by the contractor, then permission must be given in writing by the appointed competent excavation supervisor. Where uncertainty pertaining to the stability of the soil exists, the decision of a professional engineer or professional technologist competent in excavations shall be decisive. Such permission must be in writing.

The following requirements must be adhered to: Excavations:

- Excavations/trenches are inspected before every shift and a record of these inspections is kept;
- Safe work procedures have been communicated to the workers;
- The safe work procedures are enforced and maintained by the Principal Contractor's and Contractors' responsible persons at all times;
- Excavations next to permanent or temporary roadways - ensure that no load, material, plant or
- equipment is placed or moved near the edge of any excavation where it is likely to cause its collapse and thereby endangering the safety of any person, unless precautions such as the provision of sufficient and suitable shoring or bracing are taken to prevent the sides from collapsing;
- Ensure that where the stability of an adjoining building, structure or road is likely to be affected by the making of an excavation, steps are taken that may be necessary to ensure the stability of such building, structure or road as well as the safety of persons;
- Cause convenient and safe means of access to be provided into every excavation in which persons are required to work and such access shall not be further than 6m from the point where any worker within the excavation is working;
- Ascertain the location and nature of electricity, water, or other services which may in any way be affected by the work to be performed. The necessary steps must then be taken to render the circumstances safe for all persons involved. Should you as the contractor not be sure of the exact location of electrical

services, detection equipment must be used as well as a system of hand excavation as per a written risk assessment and method statement;

- Cause every excavation which is accessible to the public or which is adjacent to public roads or thoroughfares, or where the safety of persons may be endangered, to be-
 - (i) adequately protected by a barrier or fence of at least one meter in height and as close to the excavation as is practicable; and
 - (ii) provided with warning illuminates SANS or any other clearly visible boundary indicators at night or when visibility is poor;
- Cause warning signs to be positioned next to an excavation within which persons are working or carrying out inspections or tests



8.10. Heritage and Archaeological sites

If an artefact on site is uncovered, work in the immediate vicinity shall be stopped immediately. The contractor shall take reasonable precautions to prevent any person from removing or damaging any such article and shall immediately upon discovery thereof inform the Employer Agent of such discovery. The South African Heritage Research Agency (SAHRA) is to be contacted who will appoint an archaeological consultant. Work may only resume once clearance is given in writing by the archaeologist.

The demolition of heritage structures (buildings 650 year old or of specific historical value) requires specific authority before it may be demolished. The following procedure to be followed:

- The appointed contractor for the demolition will apply for the permit.
- Where the portion of historical value is required to be protected, the structural engineer will be informed to conduct a survey and prepare and issue a structural report to protect the specific area of the building.
- The contractor will implement the structural engineers report for approval before demolishing the building connected to the historical part or section.

8.11. Graves & Middens

If a grave or midden is uncovered on site, or discovered before the commencement of work, then all work in the immediate vicinity of the graves/middens shall be stopped and the Employer Agent informed of the discovery. SAHRA should be contacted and in the case of graves, arrangements made for an undertaker to carry out exhumation and reburial. The Employer will be responsible for attempts to contact family of the deceased and for the site where the exhumed remains can be re-interred. (Read with COLTO General Conditions of Contract Sub clause 4.24 as amended by Particular Condition).

8.12. Ladders GSR 13

All ladders shall be inspected on a monthly basis and shall be recorded on a ladder register. Ladder inspector shall be appointed in writing to carry out these inspections.

Extension ladders

- Extension or single ladders should be used only as a means of access or egress from a working area.
- They should not be used as working platforms,
- Any portable ladder used at the workplace should be set up on a solid surface that is stable and set up to prevent the ladder from slipping.

- Extension ladders must exceed the platform with 900mm
- All ladders must be numbered and recorded on a register
- Placing a ladder at 75 degrees angle securing single and extension ladders at both the top and bottom.



A frame ladders

- Timber portable ladders should not be painted (this can hide cracks and other defects in the timber)
- Metal portable ladders should not be used when carrying out work on electrical equipment.
- They should also not be painted as this can hide defects in the welds.
- Stepladders should be used only in their fully open position, and a person should not carry out work from a stepladder if they are standing higher than the 3rd rung from the top.

Ladder Duty Ratings		
Grade	Type	Duty Rating
Household	III	90 Kg
Commercial	II	100 Kg
Industrial Heavy Duty	I	115 Kg
Industrial Extra Heavy Duty	IA	136 Kg
Duty Rating represents maximum weight of fully clothed user plus tools and materials		



8.13. Scaffolding CR 16

All scaffolding will comply to the SANS 10085-1:2004 standard as well as with the section 16 in the construction regulation of 2014.

The following appointments shall be done if scaffolding is being done on site:

- Scaffolding erectors
- Scaffolding inspectors

- Scaffolding supervisor

All scaffolding will have a safe to use or not safe to use sign visible on the scaffolding to ensure compliance. Example of signs below:

Safe to use



Not safe to use



Scaffolding will at all times have double side rails on platform area. Platform shall be fully boarded with scaffolding hook on boards & not with wooden planks. All scaffolding will have safe access the employees can use to get to desired platform. Access on scaffolding can be with scaffolding stairs or with scaffolding access ladders

According to SANS 10085-1:2004 section 3.21 No work will be allowed on scaffolding if the wind is greater than 40 km per/hour

Each scaffolding shall be on a register and on a weekly basis and immediately after inclement weather or alterations have been made.

The Principal contractor's safety officer and construction manager will ensure that the base jacks of the scaffolding shall not be jacked more than 2/3 of the full length.

All employees working on scaffolding without double hand rail and toe boards shall wear a double lanyard safety harness with scaffolding hooks. All erectors & dismantlers shall wear double lanyard safety harness with scaffolding hooks that will be hooked on all the time to prevent falling while erecting or dismantling the scaffolding.

Mobile scaffolding will be allowed on site if it complies to the SANS 10085. All mobile scaffolding shall have a break on each wheel that will be used while working on the scaffolding. No mobile scaffolding will be allowed to be moved while employees are on top of the scaffolding.

8.14. Trestles SANS 10085

Trestles Shall not be allowed on site of the clients OHS agent did not approve it in writing. No timber trestles will be allowed on site

When approved then the following will apply for safe use of trestles.

SANS 10085 10.16:

- The minimum width of the trestle legs when opened and locked in position shall be 780 mm.
- Trestles shall not be used on slopes exceeding 1:12.
- The platform supported by the trestles shall be level within 1:50 in all directions.

All trestles shall have a double hand rail to prevent the employee from falling off the elevated platform. Safe access shall be provided for employees working on the trestles. Trestles will be inspected before each shift/day with a specific trestle checklist and after inclement weather or alterations. The platform will be packed fully with steel scaffolding platform boards and will hook onto the trestle steel frame and not exceed the length.



(b) Adjustable folding trestle (steel type)

8.15. Fall protection - Fall Risk positions CR 10

A Contractor must—

- Designate a competent person to be responsible for the preparation of a fall protection plan; ensure that the fall protection plan contemplated in paragraph (a) is implemented, amended where and when necessary and maintained as required; and take steps to ensure continued adherence to the fall protection plan.
- A fall protection plan contemplated in sub regulation (1), must include—
 - A Risk Assessment of all work carried out from a fall risk position and the procedures and methods used to address all the risks identified per location;
 - The processes for the evaluation of the employees' medical fitness necessary to work at a fall risk position and the records thereof;
 - A program for the training of employees working from a fall risk position and the records thereof;
 - The procedure addressing the inspection, testing and maintenance of all fall protection equipment; and
 - A rescue plan detailing the necessary procedure, personnel and suitable equipment required to affect a rescue of a person in the event of a fall incident to ensure that the rescue procedure is implemented immediately following the incident.

A Contractor must ensure that a construction manager appointed under regulation 10(1) is in possession of the most recently updated version of the Fall and Rescue Protection Plan.



Fall prevention and fall arrest equipment are —

- Approved as suitable and of sufficient strength for the purpose for which they are being used, having regard to the work being carried out and the load, including any person, they are intended to bear; and
- Securely attached to a structure or plant, and the structure or plant and the means of attachment thereto is suitable and of sufficient strength and stability for the purpose of safely supporting the equipment and any person who could fall; and
- Fall arrest equipment is used only where it is not reasonably practicable to use fall prevention equipment.

Fall Elimination –

The first step in work at height control is to assess the workplace and the work itself in the earliest design/ engineering stages of the project/ site and during the planned stages of all work so that potential fall hazards can be eliminated at an early stage. By doing so employees are not exposed to these potential fall hazards at any stage and work can be conducted with little exposure to fall risks and hazards.

The benefit of identifying these hazards allows for them to be included in the building phase of the job so that prevention measures are included during the construction and maintenance processes involved in the project.

Fall Prevention –

The second outlook is to assess the scope of work and potential conditions using collective protective measures. If fall hazards cannot be completely eliminated during the first step, management must take a proactive approach to the prevention of falls by improving the workplace and its conditions. In this step any hazards that arise outside of the design phase of a project are identified. This is achieved by assessing the work place and its conditions using a work at height risk assessment with the idea of implementing fall prevention measures such as guardrails, edge protection, hand rails and so forth. In this way all hazards that were not dealt with in the design phase can be addressed and a safe working environment will be achieved through the implementation of these systems.

Fall Arrest –

This is the last resort in preventing falls and individual prevention measures are assessed and implemented. In this step the condition or type of work conducted at height cannot be addressed at a design level or prevention level. In this step preventing the employee from hitting the ground is the aim, whereby systems and fall arrest equipment are used to prevent this from occurring. Equipment such as harnesses, lanyards, shock absorbers, fall arresters, lifelines, anchorage points, and safety nets can reduce the risk of injury if a fall occurs.

Life lines –

- The lifeline shall be of no less than 12.5 millimetres steel cable, able to withstand a 2.250 kg drop maintains tensile strength integrity of the material. Where steel cable cannot be used adequate lifelines in the form of ropes are to be used in accordance with manufacturing specifications able to support the above mentioned force. If a fall is expected while attached to lifeline, that line shall be replaced.
- The lifeline shall be installed in a length not to exceed 60 meters. The lifeline ends should be attached in such a manner that the ends are wrapped around a fixture so that it is facing the work area. As it is wrapped, a softener shall be installed to keep the cable from being marred or kinked.

- The cable shall be wrapped no less than one complete wrap around a beam or fixture and secured with no less than three (3) cable clamps of suitable strength. It shall be pulled to at least 45 torque kilograms.
- During installation, and as the cable is passed through each bay, it shall be attached/ supported in increments of no more than 15 meter runs. To maintain the intended height and elevate sag, the supporting material must be affixed in such a manner to be immobile.
- The supporting material must be of at least 75 x 75 mm angle iron/ steel. Holes may be tapped through the material as long as it is evenly centred, and the inside diameter edges are smooth and rounded.
- When working on elevation where there is no means for overhead attachment, supporting material shall be attached from the same elevation in an upright manner and attached.



Safety Harnesses

- Engineering contractor and all contractors/ subcontractors will provide full body harnesses meeting SABS standards. Safety belts are not allowed for fall protection.
- Standard full body harnesses are not designed for a combined personnel and tool weight in excess of 137 kg. Personnel weight more than 137 kg, with tools, must consult project/ site SHE coordinator prior to using fall arresting equipment
- All Safety harnesses are to be stored in cool dry areas and inspected on a monthly basis. Any cuts, snags abrasions are to be reported to the site supervisor and the harness discarded immediately
- Harnesses and lanyards must be checked for the following, but this the check points are not limited to this list:
 - Beginning at one end, 15 cm to 20 cm of the harness/ lanyard must be bent into a U shape. This helps reveal worn, cut, frayed, burned, or damaged fibres. Both splices and all straps along the entire length must be checked.
 - Webbing must be carefully checked at attachment points to buckles and “D” rings.
 - The shock-absorbing section of the lanyard must be checked for ripped stitches.
 - The harness/ lanyard must be checked for broken/ frayed strands.
 - Checks for rough, sharp edges; corrosion; dents or distortion; freely moving parts.

Lifeline Hooks



Scaffolding Hooks



8.16. Edge protection, Barricading and Penetrations

A Contractor must ensure that—

- All unprotected openings in floors, edges, slabs, hatchways and stairways are adequately guarded, fenced or barricaded or that similar means are used to safeguard any person from falling through such openings;
- No person is required to work in a fall risk position, unless such work is performed safely as contemplated in sub-regulation (2);
- A detailed Fall Arrest and Rescue Plan will be drafted and implemented on site.
- The above mentioned plan will be demonstrated on instruction of the Clients Safety Agent.
- Rebar that is exposed will be made safe by placing a rebar cap on, to prevent the rebar from penetrating an employee or damaging equipment

Examples of edge protection:



8.17. Roof work CR 10

A Fall protection plan must be compiled by the roof work contractors (roof structure contractor and roof covering contractor) prior to such work being undertaken. This plan must be forwarded to the H&S Agent at least two weeks before the roof supporting structural steel work is programmed to begin. External scaffolding needs to be erected and remain in position to above roof height until completion of the roof work and associated activities so as to ensure elimination of fall risks (objects and equipment falling onto members of the public). Life line systems during roof work must be designed and fitted. A part-time safety officer must be designated by the roof work contractor

The Fall protection plan must include the following:

- How the roof work is planned to be erected or worked on;
- What hazards (tasks and tools) are associated with the work;
- That the roof workers are competent (trained, experienced, knowledgeable);
- That no work is carried during inclement weather or where conditions are hazardous to workers;
- That fragile material/areas are demarcated and sign posted;
- That suitable platforms are provided where fragile materials exist;
- Safe access systems/procedures;
- Public protection safety measures and fall prevention (objects and equipment);
- The safety and health measures that will be implemented to ensure the safety and health of roof workers as well as persons working below the roof work i.e. fall prevention systems.

A fall prevention strategy must be implemented and enforced which must include a combination of safety harnesses, life lines, specified attachment points, safe access, competent personnel, supervision, tool/equipment drop prevention.

8.18. Temporary works CR 12

The PC will ensure that the provisions of the regulation CR 12:2014 are taken into consideration and appoint a temporary works designer to design to design and inspect form- and support work:

The temporary works drawing must display the design, braces, edge barricading and special safety arrangements to prevent that any part of the staging, shutter boards accidentally can be dislodge and blown over the edge in gale force winds. That the temporary works designer or formwork contractor appoints a competent temporary works supervisor that will supervise the erection of support work and covering of the deck e.g. staging or Perri system The supervisor will be in possession of a printed, approved design drawing at the point where the deck is erected. The supervisor will be in possession of an inspection document to be completed and signed by the PC supervisor accepting the deck before loading it with rebar.

- The temporary work supervisor will ensure that support work is erected in accordance with the design, that bracing and intermediate props are installed.
- That the deck is fully boarded, that boards are secured to prevent accidental dislodge incidents and all loose material is removed from the deck.
- That safe access and edge barricading are installed.
- That all safety measures to ensure shutter board (when used) are secured to prevent dislodge in gale forces wind.

Steel fixing and shuttering activities:

- Steel fixing are done under supervision of a competent supervisor following the approved bending schedule.
- Employees fixing steel close to unprotected edges must wear a safety harness connected to a safe anchor point.
- The installation of shutter boards or panels must be secured to prevent concrete spill or be accidental dislodged in gale force winds.
- Installation of rebar structures for columns and shutter panels by mobile crane must be done in conjunction of a competent banksman.
- Installation of rebar structures for columns and shutter panels by mobile crane must be done in conjunction of a competent banksman.
- Where scaffold is used for the installation of column rebar and shutter panels, the scaffold must be erected in accordance of SANS 10085

Premix concrete delivery and casting on site

The area where the concrete pump will be positioned with outriggers extended, must be demarcated and barricaded:

- The safety of public to be considered and where applicable, flagman posted
- The pump and delivery pipes to be connected and secured correctly
- Sufficient space to allow delivery trucks to stop and que for delivery of premix
- Preventative measures taken to prevent concrete spill on the road service or into the storm water system
- Casting concrete with concrete bucket
- The area where the concrete bucket is filled directly from delivery truck, must be barricaded.

- All the principles applicable to crane operations e.g. safe connections, lifting and banksman duties are valid and needed to be applied during this operation.
- A concrete bag to be installed around bucket outlet to prevent dripping spillage during transit of the concrete.
- All safety whistles and signs applied, the bucket may not be moved over a public road or walkway.
- The supervisor for the concrete pour must ensure that the bucket is empty and the safety cover is inserted over the opening before returning it for refilling.
- The PC must ensure that the concrete bucket is cleaned daily after concrete pour to prevent concrete to set in or on the bucket to prevent it from falling when accidentally dislodged.

8.19. Motorized Platforms (Streetlight installations)

The construction manager will appoint a competent supervisor that understand the hazards and risks of motorized operations, to oversee all work conducted from these platforms. Only qualified and competent operators may operate and carry out daily inspections the motorized equipment. Before lifting the platform, the equipment outriggers are extended to secure the lift. Work area under the motorised platform is barricaded to prevent unauthorised entry in the danger zone. Records are available on-site of inspections and maintenance service records. The construction manager must ensure that motorised platforms are compliant with the engineering specifications and that platforms with any damage, are removed from site. That all safety measures, equipment, stabilizing controls and engineering safety controls are serviceable before permitting the operation of the equipment. That the maximum load rating is not exceeded for the lifting machine in use. That all employees are trained specifically with the emergency procedures before permitting them working from the machines platform. That the operator is take charge of the safe use of the lifting machine and that e employees working from this platform is wearing safety harnesses attached to the platform railing. That the operator is responsible for the safety when employees are exiting the working platform to a stable steel structure of similar. That the operator is responsible for the sanitizing of the cage and controls touched by employees.



8.20. Traffic and pedestrian accommodation

The Principal Contractor must ensure that all the necessary traffic/vehicle and pedestrian accommodation safety measures are taken into account to ensure the safety of personnel and members of the public (including site visitors) both on site and adjacent to site. Such measures must be in accordance with recognised practises and to the approval of the Client and the local municipality and traffic authority. The Principal Contractor must place the necessary emphasis on safe pedestrian walkways and routings throughout the construction stage. Traffic and pedestrian accommodation drawings must be available on site as a source of reference and to assist with daily inspections and enforcement and inclusive of vehicle and pedestrian movement/management.

The principal contractor shall compile a Traffic Management Plan (TMP) to the client OHS agent & clients Agent for approval before the start of traffic accommodation. The traffic accommodation should include a sketch or a picture to explain where what signs would be displayed and to indicated detours should it be applicable. All signs need to comply to the National Road Safety Act. TCO

(Traffic Control Officer) to be appointed. No road crossings permitted at night nor any open trenches for road crossings to be left open.

8.21. Confined Spaces

Confined space is a space of any volume which, a person may at any time enter or be allowed to enter and which:

The atmosphere is liable to be contaminated at any time by dust, fumes, mist, vapor, flammable or toxic gases or other harmful substances

- The atmosphere is liable at any time to be oxygen deficient or excess
- The area is not intended to be regular workplace
- The area has restricted means of entry and exit
- The area may be subjected to engulfment
- The area is an atmospheric pressure during occupancy

Areas not normally regarded as confined spaces can become one depending on the conditions or presence of hazards.

Entry into a confined space shall not be permitted until the atmosphere has been tested to ensure safety of all personnel.

Retesting or continuous monitoring may be required because of the potential for the release of hazardous material during welding or other processes. The release of hazardous substances depends on the type of work currently being carried out, type of previous contaminant and the presence of residual chemicals. Provision should be made to continuously monitor or regularly retest the atmosphere within a confined space.

If entry is required then:

- Notify all personnel of how the task will be performed
- Ensure that lockout, tag and isolation procedures are in place
- Hazards which are involved in working in a confined space should be minimised at the design stage and during the initial installation of equipment
- An employer must ensure that before carrying out work involving entry into a confined space that a written assessment (confined space permit is carried out by a responsible person and determines the following
 - The work to be carried out
 - Is necessary to enter the confined space
 - The method by which the work can be carried out
 - The hazards involved
 - The actual method and plant proposed
 - Safety equipment required
 - Emergency and rescue procedure
 - Gas monitoring and detection necessary
 - PPE
 - Number of personnel to carry out the task
 - Number of standby personnel required

8.22. Deliveries. Waste removal. Stacking/Storage of materials

The Principal Contractor and other relevant contractors must ensure that there is an appointed stacking supervisor and all materials, formwork and all equipment is stacked and stored safely, on level, compact ground, out of access ways and no more than three times the minimum base width in height. Pallets of bricks may not be stacked more than two above each other and must be on timber

pallets. No construction materials or equipment may be stacked or stored in public areas unless authorised by LIMPOPO DEPARTMENT OF PUBLIC WORKS: ROADS AND INFRASTRUCTURE and fenced off as per the Clients requirements. Waste materials must be kept within designated construction zones. The Principal Contractor will be responsible for co-ordinating and managing this function.

Waste management arrangements to be updated to include provision for the disposal of additional waste generated due to preventative measures implemented. All waste to be managed as hazardous waste.

- a) Disposal of any gloves, masks
The contractor shall dispose of all used gloves and masks as hazardous waste and provide sealable bags and containers for the safe disposal of this waste.
- b) Paper towels ;
The contractor shall provide adequate supplies of paper towels on site. At points where these towels are provided lined waste bins to be placed in order to collect all used towels and then to be disposed of in hazardous waste.
- c) Disinfectant solution ;
The contractor to provide adequate supplies of disinfectant on site where the use of water and soap for cleaning is not practical. If disinfectant dispensers are not refilled it should be disposed with other hazardous waste.
- d) Waste water ;
Waste water at washing points, toilets, and bathrooms to be contained in a drainage system that prevent surface spills. If wastewater is contained in waste buckets it must be sealed when removed and disinfected after it is cleaned.
- e) All waste generated including masks, gloves, paper towels, etc shall be treated as health care general waste as per SANS 10248-1:2008.
- f) The waste shall be placed in plastic rubbish bags and tied when full.
- g) These plastic rubbish bags shall be placed with the normal health care waste generated for collection, removal, transportation and disposal by the relevant municipality.
- h) If health screening measures are exercised at workplaces/offices, all waste generated shall be treated as health care risk waste as per SANS 10248-1:2008.
- i) If waste is treat as health care risk waste, all the other requirements as mentioned in B above shall be adhered to.
- j) Proper hand hygiene practices must be performed/observed during and after the removal of the waste.

8.23. Fire extinguishers and fire fighting equipment

The Principal Contractor and relevant Contractors shall provide adequate, regularly serviced fire fighting equipment located at strategic points on site, specific to the classes of fire likely to occur. The appropriate notices and signs

must be posted up as required. A minimum of four 9 kg dry chemical powder fire extinguishers must be available in and around the site office establishment and stores. Fire extinguishers must also be placed at all work zones/areas, in strategic locations. Wherever *'hot work' is taking place, additional fire extinguishers must be on hand. Contractors are responsible for ensuring compliance with hot work procedures and must be in possession of method statements detailing the safe working procedures. *'Hot work' includes all work that generates a spark or flame and may therefore result in a fire.

Further, during the finishing stages of the construction phase when the finishing trades are on site, fire extinguishers will be required at strategic locations within the work areas – to be supplied and managed by the Principal Contractor.

8.24. Designated smoking area

The principal contractor will ensure that a designated smoking area will be established on site at a safe location away of chemicals or any other fire hazard, at least one fire extinguisher will be close (not further than 10 M) to the designated smoking area.

8.25. Thunder & Lighting

The management and safety personnel of the Principal Contractor shall download the lightning Alarm app from I store or google play store. The site location must be set on the app to inform the management and the safety personnel when lightning is 30 km away from the site. When the notification is received on their phones all employees (PC, Contractors & sub-contractors) working at heights must get down as fast possible. The employees are only allowed back on heights when the app has not notifies the team about lightning for at least 15 Min from the last notification.



9. Plant, equipment and machinery

9.1. Construction Vehicles & Mobile plant CR 23

Construction Plant” includes all types of plant including but not limited to, cranes, piling rigs, excavators, construction vehicles, compaction plant and lifting equipment.

The Principal Contractor must ensure that such plant complies with the requirements of the OHS Act, Construction Regulations (Feb 2014) and any manufacturers specifications. The Principal Contractor and all relevant contractors must inspect and keep records of inspections on construction vehicles and mobile plant used on site. Only authorised/competent persons in the possession of the necessary training certificates and in possession of a certificate of medical fitness may operate construction vehicles and mobile plant. Should any operator be caught making use of a cell phone while driving he will be given a written warning as well as when the operator do not wear the safety belt. All construction vehicles & mobile plant shall be fitted with rotating light & reverse hooter. Lockout procedure shall be written and implemented to ensure that no plant will be left unattended while idling and to ensure that plant will be locked out at the end of shift.

9.2. Hired plant and machinery

The Principal Contractor must ensure that any hired plant and machinery used on site is safe for use and complies with the minimum legislated requirements.

The necessary requirements as stipulated by the OHS Act and Construction Regulations shall apply. The Principal Contractor shall ensure that operators hired with machinery are competent and that competency and medical certificates are kept on site in the Health & Safety file. Any load test requirements and inspections in terms of legislation must be complied with and copies of load test certificates and inspections must be kept in the Health & Safety file. All relevant contractors

9.3. **Cranes and lifting equipment**

Cranes and Lifting Equipment must be designed and constructed in accordance with generally accepted technical standards and operated, used, inspected and maintained in accordance with the requirements of Driven Machinery Regulation 8 of the OHSAct:

- To be clearly and conspicuously marked with the maximum mass load (MML) that it is designed to carry safely. When the MML varies with the conditions of use, the table should be used by the driver/operator
- Each winch on a lifting machine must at all-time have, at least, three full turns of rope on the drum when the winch has been run to its lowest limit
- Fitted with a brake or other device capable of holding the MML. This brake or device to automatically prevent the downward movement of the load when the lifting power is interrupted
- Fitted with a load limiting device that automatically arrest the lift when
- The load reaches its highest safe position or
- When the mass of the load is greater that the MML
- Every chain or rope on a lifting machine that forms an integral part of the machine must have a factor of safety as prescribed by the manufacturer of the machine and where no standard is available the factor of safety must be:
 - Chains 4 (four)
 - Steel wire ropes 5 (five)
 - Fibre ropes 10 (ten)
- Every hook or load attaching device must be designed such or fitted with a device that will prevent the load form slipping off or disconnecting
- In addition all ropes, chains, hooks or other attaching devices, sheaves, brakes and safety devices forming an integral part of a lifting machine must be inspected every 6 months by a competent person
- All maintenance, repairs, alterations and inspection results must be recorded in a log book and each lifting machine must have its own log book.
- No person may be lifted by a lifting machine not designed for lifting persons unless in a cradle approved by the inspector or the Department of Labour.
- A clearly marked drop zone of 5 M around the crane will be identified with cones and barrier netting to keep people away from under the load

Lifting tackle:

- To be manufactured of sound material, well-constructed and free from patent defects
- To be clearly and conspicuously marked with id and MML
- Factor of safety:
 - Natural fibre ropes - 10 (ten)
 - Man-made fibre ropes & woven webbing - 06 (six)
 - Steel wire ropes – single rope - 06 (six)
 - Steel wire ropes – combination slings - 08 (eight)
 - Mild steel chains - 05 (five)
 - High tensile/alloy steel chains - 04 (four)

- Steel wire ropes must be discarded (not used any further or lifting purposes) when excessive wear and corrosion is evident and must be examined by a competent person every three months for this purpose and the results recorded.

Lifting Machine Operators

- Every lifting machine operator must be trained specifically for the type of lifting machine that he/she is operating

9.4. Explosive actuated fastening devices

The PC will ensure that the provisions of the regulation CR 21:2014 are met and ensures that explosive actuated fastening device operations including devices operated with compressed air, gas cartridge, pneumatic tools, complies to the following:

- That a competent person is appointed in writing to:
- Issue explosive actuated fastening device
- Issue explosive actuated fastening cartridges and nails (shots & pins)
- Inspect the explosive actuated fastening device before issue and on return
- Clean and maintain the explosive power actuated fastening device
- Explosive actuated device to be inspected daily before use and records to be kept
- Explosive cartridges and nails to be recorded when issued and when returned
- Explosive actuated device, cartridges and nails to be locked securely
- Explosive actuated device to be fitted with a muzzle on the end to control debris
- Only a competent appointed user may operate the explosive power actuated device

9.5. Electrical Installation and portable electrical Tools

The Electrical Engineer will ensure as far as possible that the principal contractor is made aware of the positions of all electrical installations and other services. The Principal Contractor must notify the engineer concerned should it not be sure of the location of any particular service. This is especially pertinent to the Demolitions Contractor who will need to ensure that all electrical installations are 'made safe' before demolition work begins. An installation electrician will need to prove this by means of the necessary documentation and written lock-out procedures, tags, and the like.

The Principal Contractor and contractors must comply with the Electrical Installation Regulations, the Electrical Machinery Regulations and the Construction Regulations.

The Principal Contractor must keep a copy of the Certificate of Compliance (CoC) for its temporary electrical power supply and installation. A revised CoC is required whenever the installation is altered or changed in any way. All temporary electrical installations must be inspected at least weekly by a competent person appointed in writing with records kept.

The testing and commissioning of the permanent electrical installation must be done under the management of a written method statement and detailed set of safety requirements and must only be put into use after a CoC has been issued to the principal contractor for that section/area.

Portable electrical tools and equipment must be visually inspected daily by a competent person (trained by an electrician or suitable person to carry out visual inspections on electrical tools and extension leads) before use, with records kept as proof.

All electrical work will be governed by the Electrical Installation Regulation (GNR242 – 6 March 2009) (EIR 6: Electrical Contractor 6; 7; 8).

6. Electrical contractor

(1) No person may do electrical installation work as an electrical contractor unless that person has been registered as an electrical contractor in terms of these Regulations.

(2) Any person who does electrical installation work as an electrical contractor shall register annually in the form of Annexure 3 with the chief inspector or a person appointed by the chief inspector.

(3) An application for registration as referred to in sub regulation (2) shall be accompanied by the fee prescribed by regulation 14.

(4) The chief inspector or a person appointed by the chief inspector shall register any person referred to in Sub-regulation (1) as an electrical contractor and enter such registration into the national database:

Provided that such person—

(a) has a fixed address and a telephone; and

(b) employs a registered person in a full-time capacity, or is himself or herself a registered person.

7. Certificate of compliance

(1) Subject to the provisions of sub regulation (3), every user or lessor of an electrical installation, as the case may be, shall have a valid certificate of compliance for that installation in the form of Annexure 1, which shall be accompanied by a test report in the format approved by the chief inspector, in respect of every such electrical installation.

(2) Subject to the provisions of sub regulation (3), every user or lessor of an electrical installation, as the case may be, shall on request produce the certificate of compliance for that electrical installation to an inspector, a supplier or, subject to regulation 4(1), an approved inspection authority for electrical installations.

(3) Sub regulation (1) shall not apply to an electrical installation that existed prior to 23 October 1992, and where there was no change of ownership after 1 March 1994: Provided that, if any addition or alteration is effected to such an electrical installation, the user or lessor of the electrical installation, as the case may be, shall obtain a certificate of compliance for the whole electrical installation, where after the provisions of sub regulation (1) shall be applicable to such electrical installation.

(4) Where any addition or alteration has been effected to an electrical installation for which a certificate of compliance was previously issued, the user or lessor of such electrical installation shall obtain a certificate of compliance for at least the addition or alteration.

(5) Subject to the provisions of section 10(4) of the Act, the user or lessor may not allow a change of ownership if the certificate of compliance is older than two years.

(6) The relevant supplier may at any reasonable time inspect or test any electrical installation: Provided that the supplier shall not charge any fee for such an inspection or test unless the inspection or test is carried out at the request of the user or lessor.

(7) If an inspector, an approved inspection authority for electrical installations or supplier has carried out an inspection or test and has detected any fault or defect in any electrical installation, that inspector, approved inspection authority for electrical installations or supplier may require the user or lessor of that electrical installation to obtain a new certificate of compliance: Provided that if such fault or defect in the opinion of the inspector, approved inspection authority for electrical installations or supplier constitutes an immediate danger to persons, that inspector, approved inspection authority for electrical installations or supplier shall forthwith take steps to have the supply to the circuit in which the fault or defect was detected, disconnected: Provided further that where such fault or defect is of such a nature that it may indicate negligence on the part of a registered person, the inspector, approved inspection authority for

electrical installations or supplier shall forthwith report those circumstances in writing to the chief inspector.

8. Commencement and permission to connect installation work

(1) No person shall commence installation work which requires a new supply or an increase in electricity supply capacity unless the supplier has been notified thereof in the form of Annexure 4: Provided that the supplier may waive this requirement in respect of such types of work as it may specify.

(2) No person shall connect or permit the connection of any completed or partially completed electrical installation to the electricity supply unless it has been inspected and tested by a registered person and a certificate of compliance for that electrical installation has been issued: Provided that the supplier may on request connect the supply to the electrical installation for the purpose of testing and the completion of the certificate of compliance by a registered person: Provided further that this sub regulation shall not apply in a case where the electricity was disconnected for the non-payment of the electricity account or where there has been a change of tenant but not of ownership.

9.6. General Machinery

The Principal Contractor and relevant contractors must ensure compliance with the Driven Machinery Regulations, which includes carrying out risk assessments on the machines, inspecting machinery regularly, appointing a competent person to inspect and ensure maintenance, issuing PPE and relevant clothing, and training those who use machinery.

10. Occupational Health

10.1. Industrial Hygiene

Exposure of workers to occupational health hazards and risks is very common in any work environment, especially in construction. Occupational exposure is a major problem and all Contractors must ensure that proper health and hygiene measures are put in place to prevent exposure to these hazards. Prevent inhalation, ingestion, and adsorption through the skin of hazardous chemical substances.

- Noise induced hearing loss is a highly underrated occupational condition. Occupational noise emitted by construction machinery and power tools must be controlled as far as possible by implementing engineering solutions such as noise dampening, regular maintenance, servicing and inspection, screening off the noise, and reducing the number of persons exposed. Personal protective equipment such as earmuffs and earplugs must also be used in conjunction with engineering controls so as to reduce noise exposure to below the acceptable levels.
- Heat stress is a major hazard in South Africa. The principal contractor must ensure that there is clean drink water available on site at all times and in extremes heat conditions must ensure that employees consume 600ml water an hour to prevent dehydration.

10.2. Hazardous Chemical Substance (HCS)

The Principal Contractor and other relevant contractors must provide the necessary training and information as far as the use, transport, and storage of HCS. The Principal Contractor must ensure that the use, transport, and storage of HCS are carried out as prescribed in the HCS Regulations. The Principal Contractor and contractors must ensure that all hazardous chemicals on site have Material Safety Data Sheets (MSDS) on site and the users are made aware of the hazards and precautions that need to be taken when using the chemicals.

The First Aiders must be made aware of the MSDS's and how to treat HCS incidents appropriately. Copies of the MSDS's must be kept in the first aid box and in the store. All containers must be clearly labelled. Flammable substances must be stored separately, away from other materials, and in a well-ventilated area (appropriate cross ventilation). A competent person should be appointed to be in control of this portfolio. Stores must be well ventilated, preventing the build-up of flammable and toxic gases/vapours. Should fuel storage containers be used, they must conform to the general environmental legislation and Environmental Management Plan (if a requirement on this site). The necessary safety signage must be posted up – 'no naked flames', 'no smoking'. Two 9 kg DCP fire extinguishers must be placed near to the fuel containers, but not within 5 m of the containers. These extinguishers are over and above the minimum four required for the offices and stores.



10.3. **Alcohol and other drugs**

No alcohol and/or other drugs will be allowed on site. No person may be under the influence of alcohol or any other drugs while on the construction site. Any person on prescription medication must inform his/her superior, who shall in turn report this to the Principal Contractor forthwith. Any person suffering from any illness/condition that may have a negative effect on his/her /anyone else's health or safety performance must report this to his/her superior, who shall in turn report this to the Principal Contractor forthwith. Any person suspected of being under the influence of alcohol or other drugs must be sent home immediately, to report back the next day for a preliminary inquiry. The Contractor concerned must follow a full disciplinary procedure and a copy of the disciplinary action must be forwarded to the Principal Contractor for its records.



10.4. **Medical certificate of fitness**

A contractor must ensure that all his or her employees have a valid medical certificate of fitness specific to the construction work to be performed and issued by an Occupational Health Practitioner in the form of **Annexure 3** of the construction regulations. IN this section of the safety file the principal contractor shall ensure that in front of the medicals of all the employees there will be a medicals register. All employees' medicals must be listed on this form, see attached annexure G. This annexure shall only be TYPED.

10.5. **Welfare Facilities**

The Principal Contractor will be using chemical toilets that will be strategically placed on site. The ratio is for every 30 workers on site there will be 1 chemical

toilet, When females is working on site there will be 2 toilets for every 30 workers (one for each gender). Waste bins must be strategically placed around site and emptied regularly. Shaded eating area shall be available for employees with seating and tables. The eating area shall have sufficient waste bins.

10.6. **Ergonomics**

Ergonomics is the study of how workers relate to their workstations. We advise the Principal Contractor and Contractors to take this into consideration when conducting risk assessments, thereby improving the worker-task relationship, which will in turn improve productivity and reduce chronic conditions such as back strains, joint problems and mental fatigue, amongst others. Ergonomic risk assessor shall be appointed in appointed writing and shall have the competency to perform this task.



10.7. **Snakes and Snakebites**

Snakes are the most common hazard identified in the Area of which are considered potential very dangerous. The risk posed to people by the snakes; depend on the venom toxicity, venom yield, Fang length, temperament and the bite frequency of each species. Care and precaution should be taken to avoid any contact with snakes. Should the need arise and an employee was struck of bitten by a snake, the Health & Safety Officer should be immediately informed of the situation. The employee shall be taken directly to the Hospital where the employee shall be treated by the appointed medical practitioner. Snake identification is difficult and in case an employee was bitten or struck by a snake, the snake should be captured and taken with to the local hospital or snake identification chart. The employee should be taken to the casualty section and will be assisting and treated as an emergency. If a snake should be spotted the local snake specialist must be contacted to remove the snake from site and released the snake elsewhere in a natural habitat. Snake awareness training will be conducted with all contractors employees with regards to venomous snakes in the area (**Snake Identification chart to be displayed in site office**). **Policy is not to administer anti-venom. Patients area transported via road or air based on the severity of the bite/injury.**

Contractors will be provided with African Snakebite Institute contact information.

11. COVID 19: DISASTER MANAGEMENT ACT & REGULATION: ALERT LEVEL 1

11.1. The COVID 19 is an international disaster. This is a pandemic that needs to be managed and to ensure that all our employees and visitors is safe. All precaution measures must be in place to ensure that the spread of the virus does not happen during construction. The following will shall be in place to prevent the COVID 19 virus from spreading on a construction site :

- All site entrances will be monitored by an Access Control Officer (Screening Officer) that will ensure that the employee is wearing a face shield or a mask.
- This employee will scan each worker & visitors' forehead to ensure temperature is below 37.4 degrees and medical screening questions completed.
- Each employee and visitor hands will be sanitised when entering the site and exiting the site.
- Each visitor and site employee will complete a COVID 19 questionnaire before entering the site (medical questionnaire)

- Each employee & visitor will complete the COVID 19 sign in register to keep track of the people entering the site for tracking purposes
- Lunch breaks will be rotated to ensure that at all times a social distance of 1.5 M shall be possible between employees
- Medical waste bins (Biological hazardous waste bins) shall be available at each washing station with a sealable medical waste bag that will be removed by registered service providers
- All masks, gloves, paper towels and cleaning material will be thrown into these bins to ensure no spreading of the COVID 19 virus
- All employees shall be issued with 2 masks (1 to wear, 1 in the wash)
- Non-essential visitors will not be allowed on site
- COVID 19 site rules shall be displayed at every notice board
- Notice boards shall be available at the following places: Site entrance, toilets, site offices, storerooms, eating areas, hand washing stations
- PPE issue register will be available to ensure that all employees have been issued with masks or face shields and gloves where applicable
- All hand sanitizer that is being used on site must have at least 70% alcohol and a certificate needs to be available on site (MSDS to be provided)
- A COVID 19 Guideline / procedure and Baseline risk assessment shall be in file and discussed with employees (COVID-19 Protocol)
- Emergency plan shall be changed to cover COVID 19 requirements and to ensure that assembly points is big enough to ensure a 1.5 M social distancing at all times

11.2. Symptoms of workers in contact to be checked (medical questionnaire): [DAILY]

Typical Symptoms:

- Cold/flu symptoms
- High fever
- Dry cough
- Sore throat
- Body ache (chest pain or pressure)
- Diarrhoea
- No taste or smell
- Itchy skin (rash on skin)
- Loss of speech

11.3. If persons do show symptoms what is process

Questions to be asked if person being in contact with infected person, travel patterns etc. if answered yes and enough symptoms then patient should go for testing (placed under quarantine) until tested positive or otherwise .

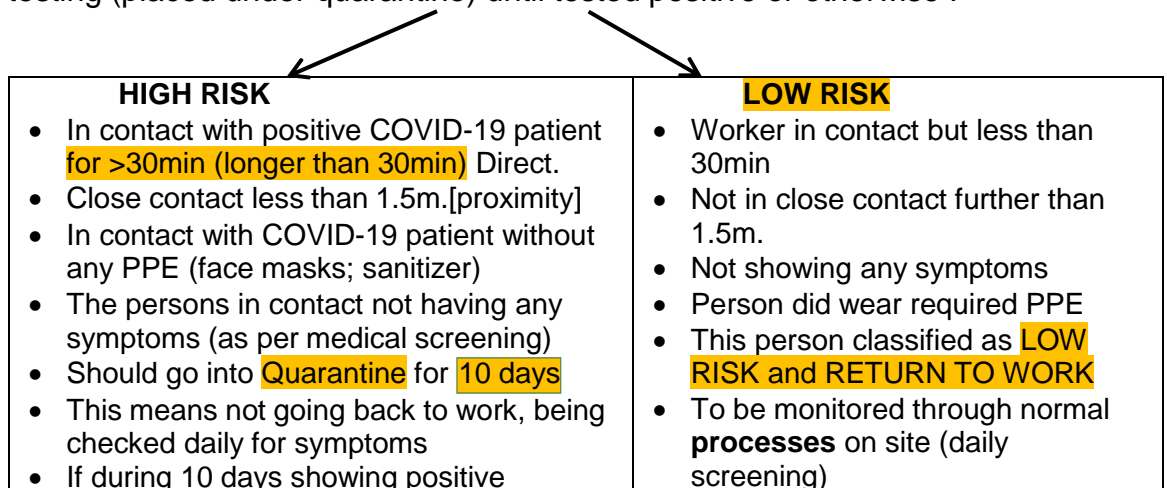

symptoms on all questions then take for testing	
--	--

We need to understand the difference between ISOLATION and QUARANTINE:

Note: When do we isolate and when do we place person tested positive or being in contact under quarantine?

ISOLATION: 10 DAYS	QUARANTINE: 10 DAYS
<ul style="list-style-type: none"> • Person who tested positive • Place in sterile environment (OWN ROOM) • No contact with anybody • Not sharing bedding; shower facilities; kitchen <ul style="list-style-type: none"> ➢ Full PPE to be provided ➢ Daily monitoring ➢ Frequent sanitization ➢ Person not allowed to travel or cross provinces ➢ Dept. of Health to monitor status and assist with daily contact either telephonic or to evaluate isolation facility. 	<ul style="list-style-type: none"> • Person to stay at home/or designated facility (separated from other employees) • Person to stay at home not to travel • Shares house with family • Wears normal PPE as prescribed • All inhabitants to be informed of status • Not advisable to send these workers back to HIGH RISK AREA, • Re-access after 10 days if no symptoms return to work • Monitor through normal processes on site

IMPORTANT: TESTING IS NOT EFFECTIVE WITHOUT SYMPTOMS

COVID-19 Positive Patients Travelling Restriction:

- If a worker/employee is positively tested for COVID-19 then the case is reported by the employer to DOH (Dept. of Health).
- No + tested person may travel or travel back to another province (not even with doctors letter).
- DOH will manage travelling if a need arise to transfer + person to another isolation area (cross border).
- All authority in this instance with the Department of Health and monitor.

11.4. CLIENT REPRESENTATIVES INSTRUCTIONS TO PERSONS BEING IN CONTACT WITH COVID PERSONS.

- Above agreed protocol to be followed and communicated to the COVID-19 tested person and persons awaiting test results.
- Screening protocol to be maintained.
- None of the persons being tested to travel to only destination especially no cross border travelling allowed.
- Individual to immediately communicate remaining COVID-19 test results to the COVID Compliance officer and clients Safety Agent in writing, as soon as provided by testing facility.

11.5. Who would have thought that in 2021 face masks would be worth gold, in the current pandemic we are facing everyone is in search for protection against the deadly virus, there are 2 main types of medical masks: Surgical mask and N9 respirators. However possessing in right face mask means nothing if you are not

using it correctly, the following steps will ensure that your mask provides you with the protection you expect from it:

- Inspect the packaging and the face mask for damage or holes before use.
- Before you don your mask, always ensure your hands are properly clean by using soap, water and an alcohol-based sanitizer.
- Fit the mask properly to cover your mouth and nose, also be sure that no open gaps are present where the mask meets your face, various masks are fitted with a metal strip that can be used to ensure the mask seals tightly around the nose; this also assists in keeping the mask in place.
- Never touch the mask while you are using it unless you have again cleaned and sanitized your hands.
- Use the mask only as instructed. Do not re-use single use masks.
- Replace your mask on a regular basis as per manufacturer requirements or the CDC recommended guide for extended use and limited re-use.
- When removing the face mask – remove it from behind (do not touch the front of the mask); discard immediately in a closed bin; clean hands with alcohol-based hand rub or soap and water.

Wearing face mask can be beneficial in preventing the spread of disease, with COVID-19 the CDC recommends wearing a face mask in public settings where social distancing is difficult for example in grocery stores and pharmacies. Research has shown that face masks are effective in stopping respiratory diseases, however we must keep in mind that is not an iron-clad guarantee that you will not get sick.





If worn properly, a surgical mask is meant to help block large-particle droplets, splashes, sprays or splatter that may contain germs (viruses and bacteria).









Your mask offers some protection to you:

A cloth mask also offers some protection to you too how well it protects you from breathing in the virus likely depends on the fabrics used and how your mask is made (e.g. the type of fabric, the number of layers of fabric, how well the mask fits). CDC is currently studying these factors.

Types of masks:

Some masks work better than others to help stop the spread of COVID-19 outside of healthcare settings. **Medical masks and N-95 respirators should not be used because they should be conserved for healthcare personnel.**

RECOMMENDED	NOT RECOMMENDED
 <p>Non-medical disposable masks</p>	 <p>Masks that do not fit properly (large gaps, too loose or too tight)</p>
 <p>Masks that fit properly (snugly around the nose and chin with no large gaps around the sides of the face)</p>	 <p>Masks made from materials that are hard to breathe through (such as plastic or leather)</p>

	<p>Masks made with breathable fabric (such as cotton)</p>		<p>Masks made from loosely woven fabric or that are knitted, i.e., fabrics that let light pass through</p>
	<p>Masks made with tightly woven fabric (i.e., fabrics that do not let light pass through when held up to a light source)</p>		<p>Masks with one layer</p>
	<p>Masks with two or three layers</p>		<p>Masks with exhalation valves or vents</p>
	<p>Masks with inner filter pockets</p>		<p>Wearing a scarf/ski mask as a mask</p>

CLOTH MASKS

The most effective fabrics for cloth masks are:

- Tightly woven fabrics, such as cotton and cotton blends
- Breathable
- Two or three fabric layers

Less effective fabrics for cloth masks are:

- Loosely woven fabrics, such as loose knit fabrics
- Difficult to breathe through (like plastic or leather)
- Single layer



NON-MEDICAL DISPOSABLE MASKS:

Disposable face masks are single-use masks. They are sold online and through large retail stores. These are not the same as surgical or other medical masks.

You may prefer using disposable masks in situations where your mask is likely to get wet or dirty. As with cloth masks, make sure your disposable mask fits close to your face without large side-gaps and completely covers your nose and mouth. Bring extra disposable masks with you in case you need to change out a dirty or wet mask.



MASKS WITH EXHALATION VALVES OR VENTS:

CDC does not recommend using masks with exhalation valves or vents because this type of mask may not prevent you from spreading COVID-19 to others. The hole in the material may allow your respiratory droplets to escape and reach others. Research on the effectiveness of these types of masks is ongoing.



SURGICAL MASKS AND RESPIRATORS:

Do not use surgical masks and respirators that are meant for healthcare workers. Currently, surgical masks and respirators are critical supplies that should be reserved for healthcare workers and other medical first responders to prevent supply shortages.



CLEAR MASKS OR CLOTH MASKS WITH A CLEAR PLASTIC PANEL:

Clear masks or cloth masks with a clear plastic panel are an alternative type of mask for people who interact with

- People who are deaf or hard of hearing
- Young children or students learning to read
- Students learning a new language
- People with disabilities
- People who need to see the proper shape of the mouth for making appropriate vowel sounds, e.g., in singing

If you use this type of mask, make sure

- You can breathe easily
- Excess moisture does not collect on the inside of the mask
- You remove the mask before sleeping, since the plastic part could form a seal around your mouth and nose and make it hard to breathe

The FDA recently approved a [transparent pdf iconexternal icon](#) medical mask. These transparent medical masks should be reserved for use by healthcare workers and patients who require them.



OTHER TYPES OF FACE PROTECTION:

CDC does not recommend using face shields or goggles as a substitute for masks. Do NOT put a plastic face shield (or a mask) on newborns or infants.

Face shields and goggles are primarily used to protect the eyes of the person wearing it. Goggles do not cover the nose and mouth. Face shields have large gaps below and alongside the face, where your respiratory droplets may escape and reach others around you. At this time, we do not know how much protection a face shield provides to people around you. However, wearing a mask may not be feasible in every situation for some people.

FACE SHIELDS AND GOGGLES:

For example, people who interact with those who are deaf or hearing impaired may find that a face shield is better than a mask when communicating. If you must wear a face shield instead of a mask:

- Choose a face shield that wraps around the sides of your face and extends below your chin or a hooded face shield. This is based on the limited available data that suggest these types of face shields are better at preventing spray of respiratory droplets.
- [Wash your hands](#) after removing the face shield. Avoid touching your eyes, nose, and mouth when removing it.

Clean and disinfect reusable face shields according to the manufacturer’s instructions or by following [CDC face shield cleaning instructions](#). If you use a disposable face shield, wear it once and throw it away according to the manufacturer’s instructions.



CONSEQUENCE MANAGEMENT:

- If any worker; or any construction site is found to be in contravention of the above said Act (Disaster Management Act 2002: Regulations in terms of Section 27(2) of Disaster Management Act 2002: Amended 12 July 2020), it could lead to criminal prosecution.
- The person/individual in default will also be subjected to the penalty clause as per the Client’s Health & Safety Specification. This is apart from the criminal prosecution that could be faced.

Every endeavor has been made to address the most critical aspects relating to Health and Safety issues in order to assist the contractor in adequately providing for the Health and Safety of employees on site. However, the Principal Contractor is required to ensure they stay compliant with statutory requirements and construction programs and processes and include such aspects in their Health and Safety File.

ANNEXURE A

SITE ESTABLISHMENT INSPECTION CHECKLIST

NO	DESCRIPTION	Y/N	COMMENTS	COMPLETION DATE
1	GENERAL SITE APPEARANCE & BARRICADING			
1.1.	Is the site layout as per the client safety Spec requirements?			
1.2.	Is the site neat and tidy?			
1.3.	Emergency assembly point practical?			
1.4.	Is the barricade done professionally Professional (Solid Barricade)?			
1.5.	One color net used (80% green shade net around as barricade)?			
1.6.	Entrance gates clearly identified?			
2	SITE OFFICES & ADMIN			
2.1.	Are Site Offices in good condition?			
2.2.	Quality Induction packs in-place (visitors & all others)			
2.3.	Safety files approved by client safety agent (Approval Letter Attached)			
2.4.	Pictures of all Emergency staff e.g. First Aiders, Fire Fighters etc.			
2.5.	Emergency Contact Numbers e.g. Hospital, Police posted?			
2.6.	List of all plant and equipment posted?			
2.7.	Are the offices sufficient numbers for the number of staff on site?			
2.8.	Are the offices adequately equipped? e.g. printer, laptop, internet, tables etc.			
2.9.	Site plans displayed e.g. Plans?			
2.10.	Health & Safety Policies Posted?			
2.11.	Legal Posters displayed (OHSACT/CONSTR REG)?			
2.12.	Letter of Good Standing Posted?			
2.13.	First Aid box available?			
2.14.	Site Safety Rules Posted?			
3	SIGNS AND NOTICE BOARDS			
3.1.	Are project signage boards on site?			
3.2.	Safety Management Information Board in-place?			
3.3.	Are there any courtesy sign boards?			
3.4.	Organogram board for site structure personnel (in site office)?			
3.5.	Safety Posters displayed?			
3.6.	Emergency assembly signs?			
3.7.	Report to site office signage?			
3.8.	General Safety Notice Boards e.g. Mandatory, Prohibitory, Warning			
4	SITE SECURITY			
4.1.	Lockable gates at all times available (site security)?			
4.2.	Site security arrangements in place i.e. watchmen, two-way radios, security, lighting, etc.			
4.3.	Community Liaison officer contacted and procedures in-place with community			
5	HEALTH AND HYGENE			
5.1.	Sufficient toilets for all staff (Male and Female, if there are females on site)?			
5.2.	Are the toilets clean and clearly identifiable (male/female)?			
5.3.	Are there sufficient refuse waste bins?			
5.4.	Clean water present on site?			
5.5.	Eating area available (table and chairs) (shaded)?			
BASED ON THE ABOVE YOU MAY CONTINUE OR NOT CONTINUE WITH CONSTRUCTION WORK				

SITE REPRESENTATIVE	DATE	SIGNATURE
WORKSAFE REPRESENTATIVE	DATE	SIGNATURE

FATALITY: An occurrence of death by accident in workplace.

LTI (LOST TIME INJURY): Any incident or accident at work resulting in a worker losing time from work.

MEDICAL TREATMENT: Any treatment by way of management & care or a patient in regard to disorder or disease.

1st AID CASE: Immediate assistance in the case of an injury before arrival of trained medical personnel.

NEAR MISS: An incident has happened, but no one was hurt, pollution did not happen or property was not damaged.

COVID-19: Worker positively diagnosed with COVID-19 virus.

D) JOB INFORMATION: HIGH RISK IDENTIFICATION:

LIST OF HIGH RISK TASKS FOR MONTH:

•
•
•
•

E) QUALITY: NON-CONFORMANCES/MITIGATION: IMPROVEMENTS FOR MONTH:

• Clients Safety Audit Results	%	• Daily safety task instructions	
• Total non-conformances for month		• Visible felt leadership	
• Completed non-conformances		• PTO (Planned Task Observations)	

F) TOOLBOX TALK TOPICS FOR MONTH FOR HIGH RISK TASKS:

CONSTRUCTION ACTIVITIES:	COVID-19 TOOLBOX TALKS FOR MONTH:
1)	1.
2)	2.
3)	3.

G) LIST SAFETY DEVIATIONS FOR THE MONTH (UNSAFE):

DEVIATION DESCRIPTION	ACTION REQUIRED	BY WHOM?	BY WHEN?
COVID-19 DEVIATIONS FOR MONTH:			

H) LIST OF EQUIPMENT/PLANT ON SITE FOR THE MONTH:					
PLANT/EQUIPMENT DESCRIPTION	TOTAL	PRE-START CHECK COMPLETED	SUB-CONTRACTOR PLANT CHECKED	TOTAL	CHECKED
•					
•					
•					
•					
•					

I) PHYSICAL SITE CONDITIONS: REMARKS:				
1) HOUSEKEEPING; BARRICADING; TRENCHES ETC.:	WORKING @ HEIGHTS		YES	NO
	Fall Protection Plan:			
	Lifting & Hoisting Plan:			
	Working @ Heights Training done:			

2) SUB-CONTRACTOR CONTROL:						
List of Sub-Contractors (Name)	Letter of Good Standing	Medicals	CR 7(1)(C)(V)	Mandatory Agreement	File approval	Permit to commence

3) COVID-19 PHYSICAL SITE CONDITIONS COMPLIANCE / NON-COMPLIANCE :				
DESCRIPTION	YES	NO	COMMENTS	
1) COVID-19 Awareness training?				
2) COVID-19 Protocol in place?				
3) Site access control: Screening process?				
4) COVID-19 Protective equipment (PPE)?				
5) Provision of hand sanitizer?				
6) Hand wash points / soap & water?				
7) Biological waste control measures?				
8) Monitoring of persons testing positive?				
9) Consequence management COVID-19?				
10) Awareness poster sets/information on COVID-19?				

J) TRAINING COMPLETED FOR MONTH:	
TRAINING COURSE NAME	NUMBER OF TRAINEES
TRAINING REQUIRED: OUTSTANDING:	

ANNEXURE C

OCCUPATIONAL HEALTH & SAFETY – HEALTH & SAFETY COSTS TO BE INCLUDED IN THE PRINCIPAL CONTRACTOR’S / CONTRACTORS’ PRICE

In terms of the Construction Regulations (2014), it is Department of Economic Development, Environment, Conservation and Tourism’s duty to ensure that the cost for Health & Safety has been provided for by the Principal Contractor, before appointment.

Acting on behalf of our Client, we require the following Health & Safety costs to be included by the Principal Contractor. It must be made very clear that these are just some of the Health & Safety costs to be included in your tender price. It is the duty of the Principal Contractor and Contractors to ensure that all aspects of the Occupational Health & Safety Act 85/1993 and Construction Regulations are catered for.

Pricing for Occupational Health and Safety measures should include the following if applicable as agreed at tender phase:

ITEM	DESCRIPTION	UNIT	QTY	RATE	AMOUNT
1	SUPPLY OF ALL ITEMS OF PERSONAL PROTECTIVE CLOTHING/EQUIPMENT & ENSURE USE THEREOF FOR FULL COMPLIANCE (INCLUDING COVID-19 COMPLIANCE PPE)				
1.1	Steel toe capped safety boots				
1.2	Overalls (at least 2x sets)	Sets			
1.3	Reflective vests(high visibility)				
1.4	Hard hats with chin strap fitted				
1.5	Dust masks as per R/A				
1.6	Hearing protection				
1.7	Hand gloves (as per R/A: Drilling; jack hammer etc.)				
1.8	Safety goggles: COVID-19 testing personnel x2 sets	Sets			
1.9	Full face shields for 1 st Aide & Screening officer	Sets			
1.10	Surgical gloves (cleaning personnel & Screening Officer)				
1.11	3 layered cloth masks (different colours)	Sets			
2	SUPPLY AND PROVISION OF EQUIPMENT FOR WORKING AT HEIGHTS & ENSURE USE				
2.1	Fall protection equipment (Safety Harness)				
2.2	Double lanyard harness				
2.3	Scaffolding access ladders/toe boards/hand rails				
2.4	Portable Ladders (ladders excavations)				
2.5	Any other: Principal Contractor to specify (if required by the task & R/A)				
3	BARRICADING: SUPPLY & INSTALL, INCLUDING REMOVAL UPON COMPLETION TO ENSURE FULL COMPLIANCE TO LEGISLATION (CR 13 EXCAVATIONS)				
3.1	Rigid type barricading (open trenches) orange netting – droppers 2m intervals	m			
3.2	Temporary fence barricading along perimeter of excavated	m			
3.3	Contractors site camp facility fence 1.8m. bonox fence (80% green shade net covered)	m			
3.4	Fencing of waste disposal area: Green netting 1.8m @ 80% green shade net bonox fence	m			
4	TRAINING REQUIREMENTS: IF NO PROOF PROVIDED				
4.1	First Aid Training				
4.2	Health and Safety Representative training (in house)				
4.3	Emergency Rescue training(Height)				
4.4	Hazard Identification Training (Risk Assessor)				
4.5	Training of Personnel working at heights (trenches deeper than 1.5m)				
4.6	Construction Plant Training (TLB; Excavator; Trucks)				

4.7	Cleaning personnel Training				
4.8	Scaffold Erector and Inspector Training (if applicable)				
4.9	COVID-19 Awareness Training (in house)				
5	OCCUPATIONAL HEALTH AND SAFETY ADMINISTRATION				
5.1	Develop of a Site Specific Health and Safety Plan and Hazard and Risk Assessment by Competent person. Including Risks for COVID-19 (Combined file)	File			
5.2	Develop of Fall Protection and Rescue Plan by a Competent Fall Protection Plan Developer.	FPP			
5.3	Competent Occupational Health and Safety Officer/ Consultant.	Months			
6	EMPLOYEES MEDICALS: CR 7(1)(G)				
6.1	Medical form Occupational Practitioner on Annexure 3 format Including COVID-19 medical questionnaire	p/p			
7	ACCESS CONTROL: COVID-19 SCREENING				
7.1	Security officer full time/access control	Month			
7.2	Screening officer full time access/COVID-19	Month			
7.3	Screening equipment: - Table; chair; clipboard - Non-contact thermometer	Them			
7.4	Hand sanitizer point at access	Unit			
7.5	Isolation area at access control point: Shade net structure well ventilated withy signage (isolation area)	Isol Area	3x4m		
	4x Chairs (1.5m spacing)	Chair			
8	WORKER WELFARE FACILITIES:				
8.1	Toilet facilities (chemical) 1:30. 1x each sex (also provide for personnel hand sanitizer for each toilet				
8.2	Staggered eating area: (staggered eating times for employees) (shade net structure) - Chairs & tables (social distancing 1.5m)	Sum			
	- 2x Bins at eating area (biological waste)	Bins			
	- 1x Hand wash point & soap at eating area	Hand wash			
	- Paper towel roll for hand cleaning	Roll			
8.3	Changing area/lockers for each sex	Area			
9	OTHER EQUIPMENT: COVID-19 COMPLIANCE:				
9.1	Hand sanitizer (70% alcohol based) & refill	500ml			
9.2	Disinfectant applied by knapsack sprayer for tools; offices; screening area (allow for whole construction period)	Sum	Sum		
9.3	Hand wash points @ work area	Hand wash			
9.4	1 st aid kits (1x kit for every 25 persons)	Kit			
9.5	Waste bins (biological waste; domestic waste) lined with plastic bags (waste management	Bins			
9.6	Fire extinguishers (9kg) office & work area/eating area/ tool shed) CR 29	9kg			
9.7	Hazardous chemical cage: Lockable with signage: Well ventilated – CR 25	Unit			
10	SAFETY SIGNAGE INCLUDING COVID-19 AWARENESS:				
10.1	General notices/signs/site awareness board				
10.2	Directional signage (emergency assembly)				
10.3	Scaffold tags (Red/Green)	Tags			
10.4	COVID-19 Awareness notices & signs				

ANNEXURE D

The Occupational health and Safety File must consist out of the following documentation: File 1

MASTER LEGAL SAFETY FILE INDEX

NR	INDEX/DESCRIPTION	LEGAL REF
1.	APPOINTMENT LETTER FROM THE CLIENT; Acceptance to be signed by both client and contractor	CR 5[1][K]
2.	NOTIFICATION OF CONSTRUCTION WORK Documents to be signed by both parties and submitted to DOL [to be stamped]	CR 4[1]
3.	LETTER OF GOOD STANDING – COID Document to be valid until completion of works	CR 7[1][IV]
4.	COPY OF PUBLIC LIABILITY INSURANCE POLICY; Insurance cover to be valid until completion	CLIENT SPEC/LEGAL
5.	HEALTH AND SAFETY SPECIFICATIONS[CLIENT] SPEC to be provided to contractor at tender stage	CR 5[1][b]
6.	BASELINE RISK ASSESSMENT [CLIENT] Client to provide at the tender stage	CR 5[1][a]
7.	SECTION 37.2 MANDATORY AGREEMENT [Each page to be initialled by both parties and on last page plus witness]	OHSACT SECT 37
8.	SCOPE OF WORK/TOOL MACHINERY LIST [contractor scope as per BOQ, and tools /equipment to perform the task	CLIENT SPEC
9.	METHOD STATEMENT OF ALL WORK THAT WILL BE CONDUCTED [Sequence of tasks, how will it be performed with SWP?	DUTY OF EMPLOYERS OHSACT 8
10.	RISK ASSESSMENT GUIDE/PROCEDURE (PLAN) How will risks/hazards be identified, incl R/A MONITORING AND REVIEW PLAN	CR 9 [1]-[7] OHSACT 8[2][b]
11.	SPECIFIC ISSUE BASED RISK ASSESSMENTS; Risk Matrix and Issue based risk controls, including LMRA [Last minute R/A]	CR 9[1]-[7]
12.	SAFE WORK PROCEDURE OF ALL RISKS [Should be aligned to scope and R/A	OHSACT 8
13.	MEDICAL CERTIFICATES; To be issued by Occupational Medical Practitioner on ANNEX 3 format [Practice number to be reflected]	CR 7[1][g]
14.	ALL HEALTH AND SAFETY RELATED POLICIES; Safety policy, PPE policy, Drug /Alcohol policy; HIV AIDS POLICY & COVID-19 POLICIES	DUTY EMPLOYER; ACT 8
15.	SITE SPECIFIC EMERGENCY NUMBERS AND EMERGENCY PLAN; Site specific aligned to client spec	DUTY OF PC [CONSTR REG 7
16.	SITE SPECIFIC HEALTH AND SAFETY PLAN; How will contractor implement Health and safety/aligned and referring to client spec.	CR 7[1][a]
17.	SITE SPECIFIC FALL PROTECTION AND RESCUE PLAN; Compiled by competent FPP developer UNIT standards 229998/229994	CR 10[2]
18.	INCIDENT/ACCIDENT MANAGEMENT CONTROL/PLAN PROCEDURE; Procedure on how to handle incident; ANNEX 1; WCL 1 AND 2; WCL 4; Incident investigation report format	OHSACT [ACT 24]
19.	TRAFFIC MANAGEMENT PLAN; Should include traffic lay out design	CR 23[2]
20.	ENVIRONMENTAL MANAGEMENT PLAN; as per clients environmental requirements	ENVIRONMENTAL REG FOR WORKPLACES
21.	SUB-CONTRACTOR CONTROL	CR 7
22.	HAZARDOUS CHEMICAL SUBSTANCE REGISTER AND MSDS; List only which applicable per scope .Induct workers on MSDS	HAZ CHEM SUBSTANCES REG
23.	MONTHLY HEALTH AND SAFETY REPORT; Template of monthly OHS report ,provided by client; CHSO to complete monthly	CR 7 DUTIES OF CONTRACTOR/ CLIENT SPEC
24.	HEALTH AND SAFETY ORGANOGRAM; Should be site specific and for CONSTRUCTION WORK PROJECTS	CR 8 MANAGEMENT OF CONSTR WORK
25.	OCCUPATIONAL HEALTH AND SAFETY (CONSTRUCTION) APPOINTMENTS – WITH COMPETENCIES; Each legal appointment to be on the letterhead of the company ,fully signed between both parties, and attach proof of competency	
	• CEO; To be signed by company CEO	OHSACT SECT 16.2
	• DELEGATION OF DUTIES; If more than one project CEO, assign duties to full time representative of company	OHSACT SECT 16.2

	<ul style="list-style-type: none"> PRINCIPAL CONTRACTOR ;CR 5 between client and PC ,and CR 7 between PC and sub 	CR 5[1][K] / CR 7[1]C[V]
	<ul style="list-style-type: none"> CONSTRUCTION SUPERVISOR 	CR 8[7]
	<ul style="list-style-type: none"> CONSTRUCTION MANAGER-Full time on site; Determined by size of project 	CR 8.1
	<ul style="list-style-type: none"> HEALTH AND SAFETY OFFICER- Determined by risks on project; Should be registered from SACPCMP [Letter of good standing provided 	CR 8.5
	<ul style="list-style-type: none"> SHE REPRESENTATIVES 	SECT 17[1] ACT
	<ul style="list-style-type: none"> INCIDENT INVESTIGATOR(S) Proof of competency to be provided 	GAR 8
	<ul style="list-style-type: none"> FIRST AID ATTENDANT [When more than 10 employees employed; at least level 1 	GSR 3[4] AND [5]
	<ul style="list-style-type: none"> RISK ASSESSOR; Competency required under CR 9 [Certified Training Authority] 	CR 9
	<ul style="list-style-type: none"> FALL PROTECTION PLANNER [Qualified and competent; SAQA UNIT STANDARDS; 229998, AND 229994. [IWH] 	CR 10
26.	COPY OF THE OCCUPATIONAL HEALTH AND SAFETY ACT AND CONSTRUCTION REGULATIONS 2014; Poster format and copy in file or booklet format	
27.	COPY: DISASTER MANAGEMENT ACT 2002 REGULATIONS ISSUED TERMS OF SECT 27(2) OF DMA	
28.	COPY OF ERGONOMICS REGULATIONS - 2019	

WORK SAFETY FILE INDEX:

Important: All induction material; toolbox talks; checklists & registers to be filed in separate work file

NR	DESCRIPTION	APPLICABLE	
		YES	NO
1.	INDUCTION MATERIAL		
2.	TOOLBOX TALKS		
3.	HEALTH & SAFETY REP: DAILY SITE INSPECTION CHECKLIST		
4.	MINUTES OF SAFETY COMMITTEE MONTHLY MEETINGS		
5.	CONSTRUCTION HEALTH & SAFETY OFFICER WEEKLY SAFETY REPORT - MONTHLY REPORT		
6.	FIRST AID - CHECKLIST - DRESSING RECORD		
7.	PPE (PERSONAL PROTECTIVE EQUIPMENT) - PPE ISSUE REGISTER - PPE CHECKLIST		
8.	FIRE PREVENTION - PORTABLE FIRE EQUIPMENT CHECKLIST - FIRE EQUIPMENT REGISTER & DEVIATIONS		
9.	DAILY HOUSEKEEPING CHECKLIST		
10.	SITE WORKERS WELFARE CHECKLIST - FACILITIES & HYGIENE		
11.	TOILET WEEKLY INSPECTIONS CHECKLIST		
12.	HAND TOOLS - WEEKLY INSPECTION CHECKLIST - HAND TOOLS REGISTER		
13.	PETROL/DIESEL GENERATOR DAILY CHECKLIST		
14.	PORTABLE ELECTRICAL TOOLS DAILY INSPECTION CHECKLIST		
15.	COMPRESSOR DAILY CHECKLIST		
16.	WALK BEHIND PLATE COMPACTOR CHECKLIST		
17.	WELDING & GAS CUTTING - INSPECTION CHECKLIST		

	- REGISTER		
18.	CONCRETE MIXER INSPECTION CHECKLIST		
19.	STACKING & STORAGE CHECKLIST		
20.	DAILY EXCAVATION CHECKLIST		
21.	HAZARDOUS CHEMICAL SUBSTANCE CHECKLIST		
22.	LADDER INSPECTIONS - LADDER CHECKLIST - LADDER REGISTER		
23.	SCAFFOLDING (WORKING @ HEIGHTS) CHECKLIST		
24.	WORKING AT HEIGHTS CHECKLIST		
25.	FORM & SUPPORT WORK INSPECTION CHECKLIST		
26.	FALL ARREST EQUIPMENT - INSPECTION CHECKLIST - SAFETY HARNESS REGISTER		
27.	MOBILE PLANT - MOBILE CRANE CHECKLIST - TLB INSPECTION CHECKLIST - EXCAVATOR CHECKLIST - TIPPER TRUCK CHECKLIST - COMPACTION EQUIPMENT – DRUM ROLLER CHECKLIST - LDV DAILY CHECKLIST		
28.	COVID-19: MANAGEMENT SYSTEM - SOCIAL DISTANCING CONTROL SHEET - ACCESS CONTROL SHEET - SANITAZION CONTROL SHEET		

ANNEXURE E

NOTIFICATION OF CONSTRUCTION WORK

**OCCUPATIONAL HEALTH AND SAFETY ACT, 1993
(Regulation 4 of the Construction Regulations. 2014)**

NOTIFICATION OF CONSTRUCTION WORK

1. (a) Name and postal address of principal contractor:

(b) Name and tel. No of principal contractor's contact person:

2. Principal contractor's compensation registration number:

3. (a) Name and postal address of client:

(b) Name and tel. No of client's contact person or agent:

4. (a) Name and postal address of designer(s) for the project:

(b) Name and tel. No of designer(s) contact person:

5. Name and telephone number of principal contractor's construction supervisor on site appointed in terms of regulation 8(1).

6. Name/s of principal contractor's sub-ordinate supervisors on site appointed in terms of regulation 8(2).

7. Exact physical address of the construction site or site office:

8. Nature of the construction work:

9. Expected commencement date: _____

10. Expected completion date: _____

11. Estimated maximum number of persons on the construction site.
Total: _____ Male: _____ Female: _____

12. Planned number of contractors on the construction site accountable to principal Contractor: _____

13. Name(s) of contractors already selected.

Principal Contractor

Date

Client's Agent (where applicable)

Date

Client

Date

THIS DOCUMENT IS TO BE FORWARDED TO THE OFFICE OF THE DEPARTMENT OF LABOUR **PRIOR TO COMMENCEMENT** OF WORK ON SITE.

Copies:

1. Original to **Department of Labour**
2. Copy on Health and Safety File

ANNEXURE F

HEALTH & SAFETY MEETING MINUTES

Project Name:	DOC NO	
	PAGE	1 of 5
Principal Contractor:	REV	
	DATE	

HEALTH AND SAFETY MEETING MINUTES
LEGAL REFERENCE: OHSACT SECT 19(4)

Minutes of an Occupational Health and Safety Committee Meeting

held on: Date: _____

Venue: _____



NOTE: Health & Safety Committee to be chaired by the Construction Manager (CR 8.1)

1. ATTENDANCE

NAME	DESIGNATION	SIGNATURE

2. APOLOGIES

NAME	DESIGNATION	SIGNATURE

2. MATTERS OUTSTANDING FROM PREVIOUS MEETING.

	TASK DESCRIPTION	BY WHOM?	BY WHEN?
2.1. SAFETY ADMIN CONTROLS EQUIPMENT			
1)	Safety Policies		
2)	37.2 Agreements (P.C & Sub-contractors)		
3)	Weekly & Monthly Reports		
4)	Legal appointments		
5)	Monthly safety audits: Sub-contractors		
2.2. RISK ASSESSMENTS (ON-GOING)			
1)	Continuous (Last Minute R/A)		
2)	Review		
3)	Baseline R/A Review		
2.3. WORKER INDUCTION TRAINING			
1)	Medical Certification (Annex 3)		
2)	Confirmation of competencies		
3)	Visitor inductions		
4)	COVID-19 screening		
2.4. HYGIENE FACILITIES			
1)	Toilet facilities		
2)	Waste bins (biological waste/normal waste)		
3)	Hygiene in eating area		
4)	Daily sanitation (cleaning of facilities)		
2.5. SITE CAMP & PUBLIC SAFETY/SIGNAGE			
1)	1 ST Aid facilities		
2)	Visible signage		
3)	Directional signage		
4)	Emergency routes / assembly		
2.6. GENERAL			
1)	Emergency drills: When conducted?		
2)	Sub-contractor control: Number?		
3)	Environmental Management		
4)	Hazardous Chemicals (MSDS)?		
5)	Incident Investigation		
6)	Number of incidents for month		

3. MATTERS OF MEETING

	TASK DESCRIPTION	BY WHOM?	BY WHEN?
3.1. SAFETY ADMIN CONTROLS			
	Safety Policies / Including COVID-19 Policies		
	37.2 Agreements		
	Letter of Good Standing: Status		

Keeping daily records/checklists			
Challenges with admin controls?			
Completion of DSTI's (SHE Reps)			
Legal appointments checked?			
3.2. RISK MANAGEMENT: HIGH RISK TASKS FOR MONTH			
Last Minute R/A			
List high risks			
3.3. SHE REP REPORTING: ISSUES REQUIRING IMMEDIATE ATTENTION:			
SHE REP 1:			
SHE REP 2:			
SHE REP 3:			
SHE REP 4:			
SHE REP 5:			
3.4. TRAINING / INDUCTION:			
Training presented in month			
Training needs / required?			
3.5. COVID-19 REPORTING:			
Recordable cases?			
Screening challenges?			
Reportable cases?			
COVID-19 material required? - Sanitizer - Thermometers - Soap - Bins - Cloth masks (3x sets/worker)			

- COVID waste control			
3.6. INCIDENT RECORDED / REPORTED:			
Number of incident for month?			
Minor/major/fatal?			
Any reportable incidents?			
Annex 1: WCL 2; WCL 4; WCL 5 (Final medical)			
Major causes of incidents?			
Any fall from heights incidents?			
What mitigation implemented?			
3.7. SITE LAYDOWN AREA:			
Physical site conditions			
Stacking & storage status?			
Any obstructions walkways?			
General status of housekeeping?			
Controls implemented/suggested to improve lay-down area lay-out?			
Fencing of lay-down area			
3.8. FALL RISK MANAGEMENT:			
All workers working at heights trained W@H?			
Fall protection plan approved?			
Workers inducted on Fall risks?			
Competencies verified for scaffold erectors; inspectors; supervisors?			
Any fall risks identified?			
What controls required to mitigate?			
Status of temporary work platforms			
Scaffolding compliant in regard to SANS?			
R/A covering all W@H situations?			
Registers/checklists completed for fall arrest equipment?			
3.9. MANAGEMENT OF EXCAVATIONS; OPENINGS:			
R/A in place for deep excavations?			
Signage displayed for deep excavations?			
Barricading sufficient?			
Excavations daily checks completed (competent person)?			
Challenges identified			
Controls required in terms of deep excavations?			
Emergency Plan for excavations			
Safe access /egress			
3.10. TRAFFIC MANAGEMENT CONTROL:			
Is TMP in place and communicated?			
Is TCO appointed			
Is traffic controlled by means of traffic lay-out design			

Correct signage displayed?			
Any shortcomings identified?			
Controls required in R/A?			
3.11. WASTE MANAGEMENT CONTROL:			
Domestic waste separated from building rubble?			
Bins/skips provided for waste?			
Waste management (regular intervals for removal)			
Challenge in regard to waste control?			
Controls suggested to improve?			
3.12. SUB-CONTRACTOR CONTROL:			
Number of sub-contractors?			
Permit to commence issued?			
Sub-contractor list of compliance status in place?			
Safety files approved?			
Non-compliance/consequence management applied?			
Challenges identified with sub-contractor management?			
3.13. EMERGENCY PLANNING:			
Emergency numbers posted			
Emergency drill practices for month			
Emergency procedures handled / communicated?			
Challenges			
Controls required			
Emergency assembly point signage displayed.			
3.14. LIFTING/HOISTING OPERATIONS:			
Proof of lifting plan			
Communicated?			
Competent operators appointed?			
Riggers/banksmen approved?			
Lifting operations communicated?			
Challenges identified			
Controls suggested by committee?			
3.15. WORKERS FACILITIES CR 30:			
Changing facilities			
Toilet facilities: Ratio 1:30			
Hygiene at worker facilities			
Enough seating available in eating areas			
Bins provided / hand wash points paper towels			
Special distancing			
Staggered eating times?			
Challenges identified/shortages			
Controls suggested by committee			
3.16. PLANT/EQUIPMENT:			

List of plant & tools on site			
Daily checks conducted			
All operators medicals/competencies			
Overall status of plant			
Challenges			
Controls suggested for improved control			
3.17. ELECTRICAL INSTALLATIONS CR 24:			
R/A for electrical installations			
Installations by competent electrician (check competencies)			
COC's provided for temporary electrical installations?			
Status of DB Boxes (installations)			
Daily checklists conducted			
Challenges			
Controls required for improvement			
3.18. BLASTING ACTIVITIES:			
Blaster submitted Safety file (approved)?			
Blaster registered at DoEL			
Blasting permits (SAPS)			
Transport permit provided			
CV of blaster verified			
DoEL notified of blasting scheduled			
Method Statements; SWP			
Correct PPE/Emergency plan misfire procedures?			
3.19. PPE MANAGEMENT:			
PPE register & issue register			
PPE daily checklists completed on status			
Correct PPE for tasks			
Correct PPE for tasks			
Correct PPE for COVID-19 issued: Cloth mask x3 sets			
Visibility of workers			
Challenges			
Controls suggested?			
3.20. FIRE MANAGEMENT CONTROL:			
Correct firefighting equipment provided			
Correct signage/placement			
Training of firefighters?			
Workers training of fire emergency drills			
Toolbox Talks on firefighting			
Challenges?			
Controls required			
3.21. SECURITY/ACCESS CONTROLS:			
Measures sufficient			
Locked entrance			

Security provided night/daytime?			
Proper admin controls for access control			
Visitor screening/access control			
Challenges to improve security?			
Controls required?			
3.22. REWARDS & PENALTY SYSTEM: CONSEQUENCE MANAGEMENT:			
Rewards system in place			
Penalty system			
Near miss reporting			
Suggestions to improve?			
3.23. GENERAL ISSUES:			
1)			
2)			
3)			

4. CLOSURE OF MEETING:

Meeting adjourned at _____ Next meeting will be held on _____

Signed:

Chairman (Health and Safety Committee)

Date

Site Manager

Date